



US00D854394S

(12) **United States Design Patent**
Rademacher et al.

(10) **Patent No.:** **US D854,394 S**

(45) **Date of Patent:** **** Jul. 23, 2019**

(54) **HANDLE FOR A FLOATING WATERPARK**

(71) Applicant: **Wibit Sports GmbH**, Bocholt (DE)

(72) Inventors: **Romann Rademacher**, Bocholt (DE);
Robert Cirjack, Bocholt (DE)

(73) Assignee: **WIBIT SPORTS GMBH**, Bocholt
(DE)

(**) Term: **15 Years**

(21) Appl. No.: **29/611,647**

(22) Filed: **Jul. 24, 2017**

(30) **Foreign Application Priority Data**

Jan. 26, 2017 (EM) 003712819-0001

(51) **LOC (11) Cl.** **08-06**

(52) **U.S. Cl.**
USPC **D8/303; D21/803**

(58) **Field of Classification Search**
USPC D8/307, 308, 331, 343, 367, 394, 395,
D8/398; D21/803

CPC Y10T 74/20612; Y10T 74/2014; Y10T
74/20696; Y10T 74/20396; Y10T 74/206;
Y10T 74/20618; Y10T 74/19251; Y10T
74/2011; Y10T 29/49826; Y10T
74/20213; Y10T 74/20822; Y10S 292/27;
Y10S 292/53

See application file for complete search history.

(56) **References Cited**

U.S. PATENT DOCUMENTS

5,533,952 A * 7/1996 Schaber A63B 22/0012
482/70
D525,105 S * 7/2006 Jackson D8/107

D527,606 S * 9/2006 Jackson D8/107
D712,231 S * 9/2014 Thompson D8/300
D713,234 S * 9/2014 Gates D8/303
9,296,121 B1 * 3/2016 Jimenez B23D 51/01
D764,889 S * 8/2016 Merten D8/107
D782,894 S * 4/2017 DePietro D8/107
D825,015 S * 8/2018 Rademacher D21/803
2006/0067801 A1 * 3/2006 Van Bergen B25F 5/026
409/182
2006/0130275 A1 * 6/2006 Tong A45C 13/262
16/113.1
2006/0168761 A1 * 8/2006 Christensen A45C 13/26
16/444
2017/0043909 A1 * 2/2017 Nelson B65D 25/2808

* cited by examiner

Primary Examiner — Lauren R Calve

(74) *Attorney, Agent, or Firm* — Arent Fox LLP

(57) **CLAIM**

The ornamental design for a handle for floating waterpark,
as shown and described.

DESCRIPTION

FIG. 1 is front left perspective view of a handle for a floating
waterpark showing our new design;
FIG. 2 is a front view of the design shown in FIG. 1;
FIG. 3 is a back view of the design shown in FIG. 1;
FIG. 4 is a left side view of the design shown in FIG. 1;
FIG. 5 is a right side view of the design shown in FIG. 1;
FIG. 6 is a top view of the design shown in FIG. 1; and,
FIG. 7 is a bottom view of the design shown in FIG. 1.

1 Claim, 7 Drawing Sheets

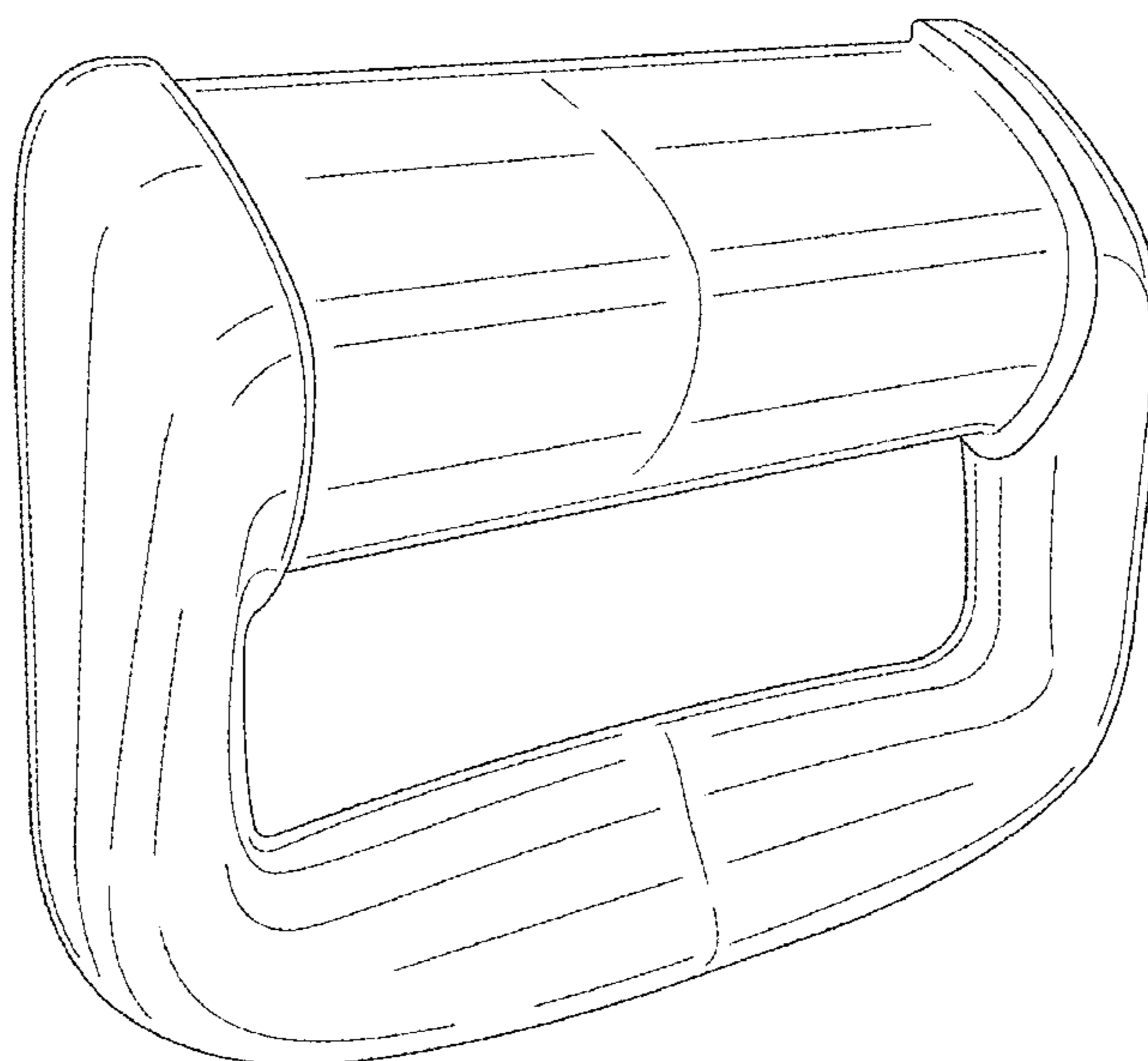

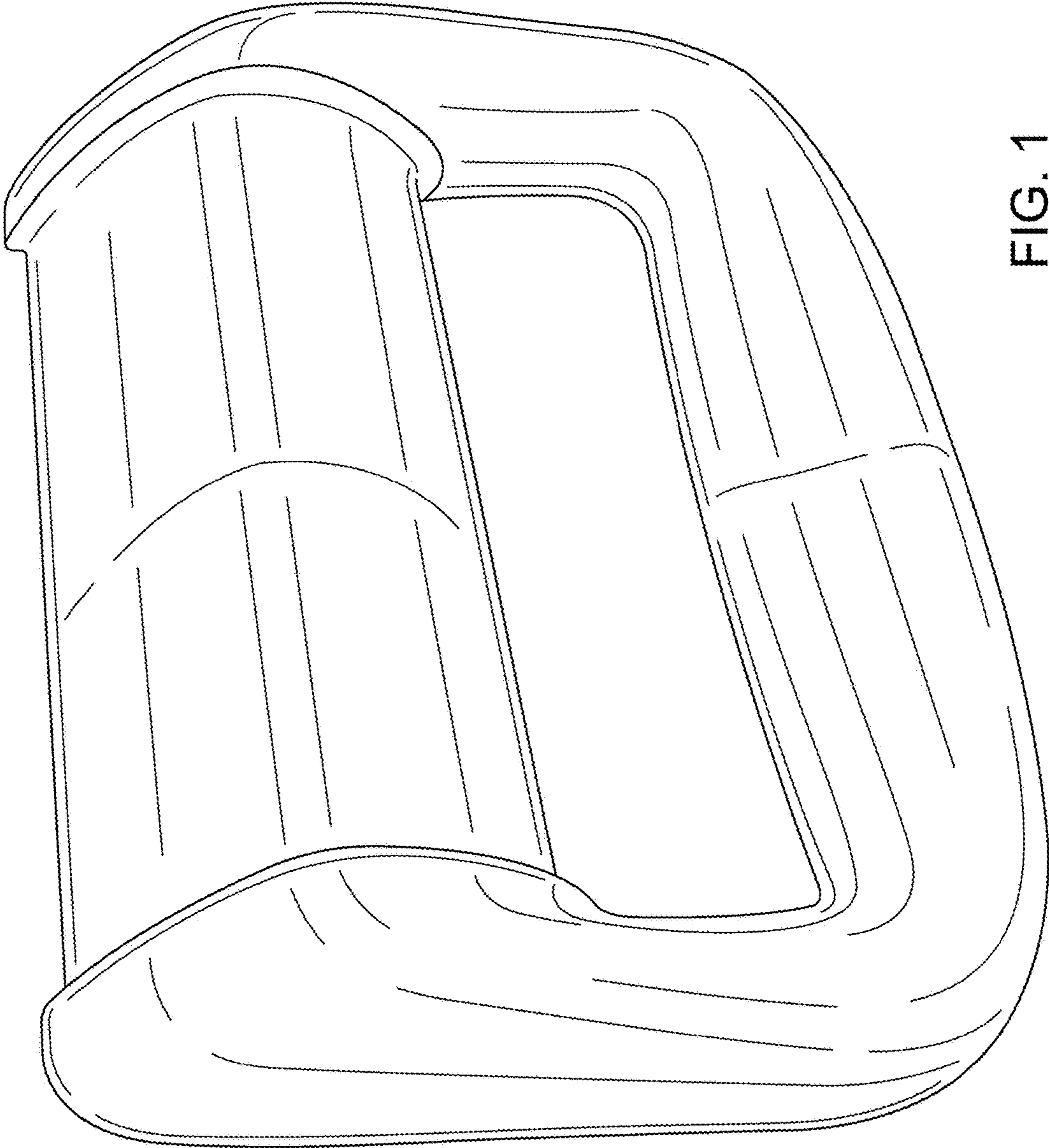

FIG. 1

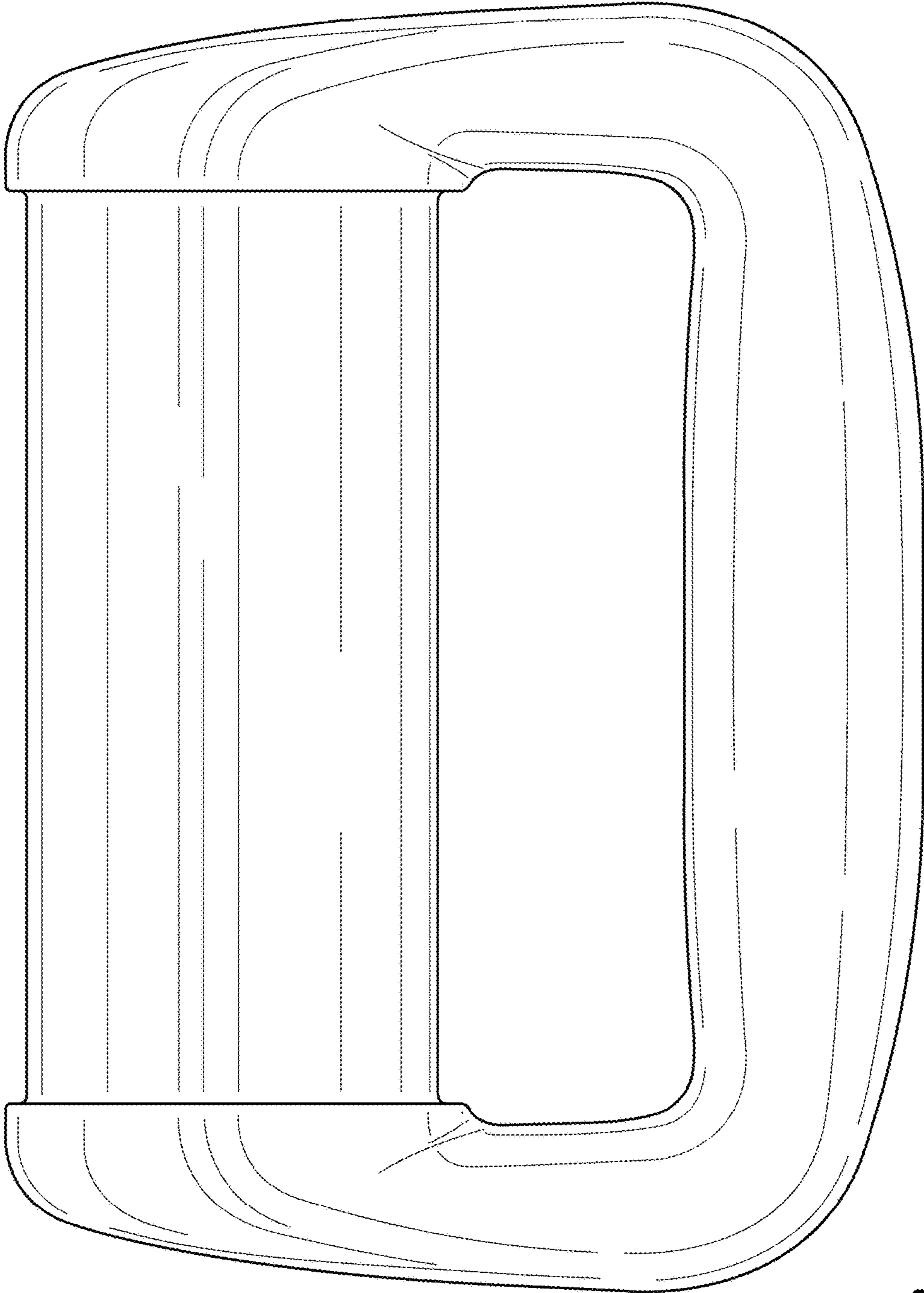

FIG. 2

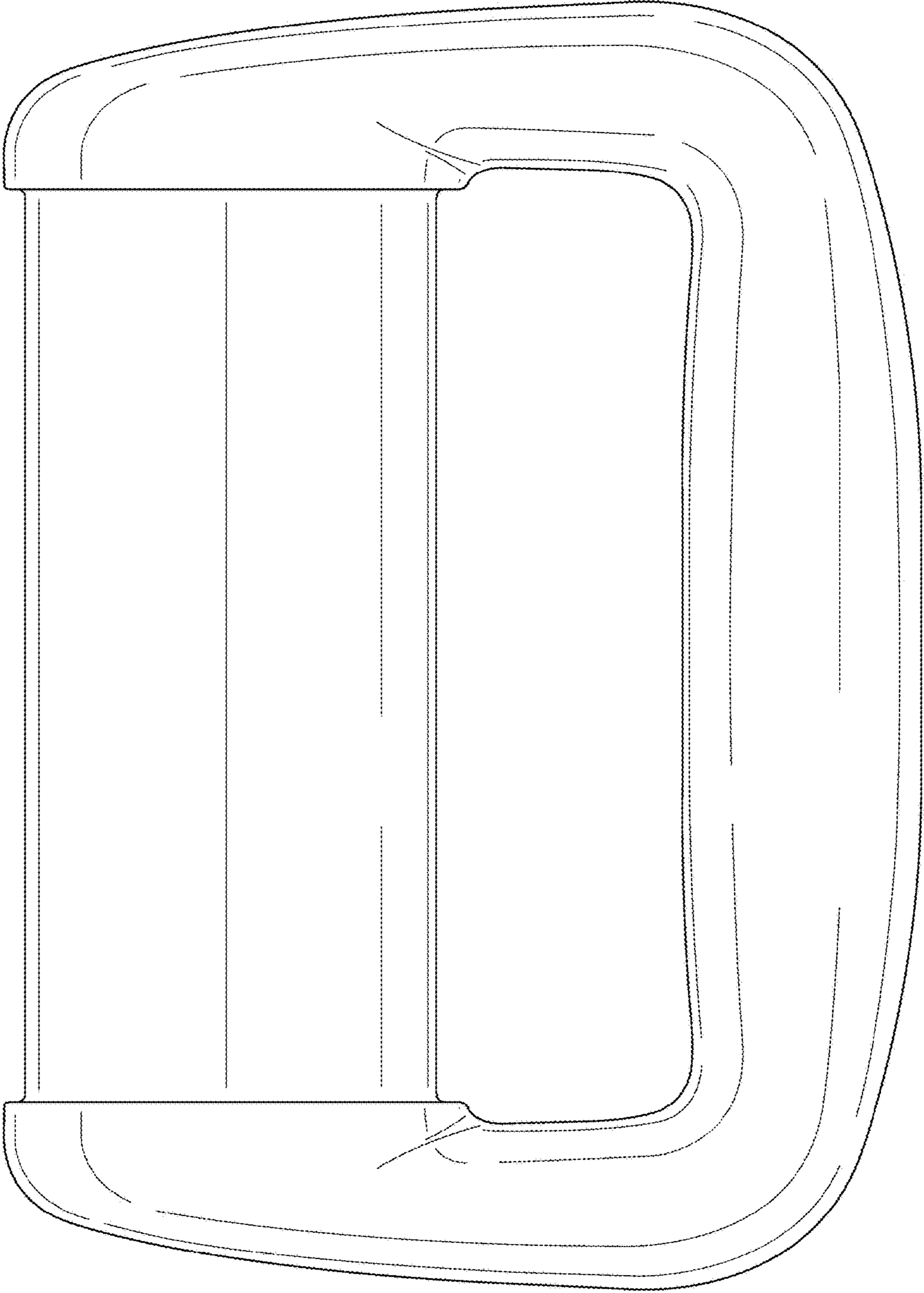

FIG. 3

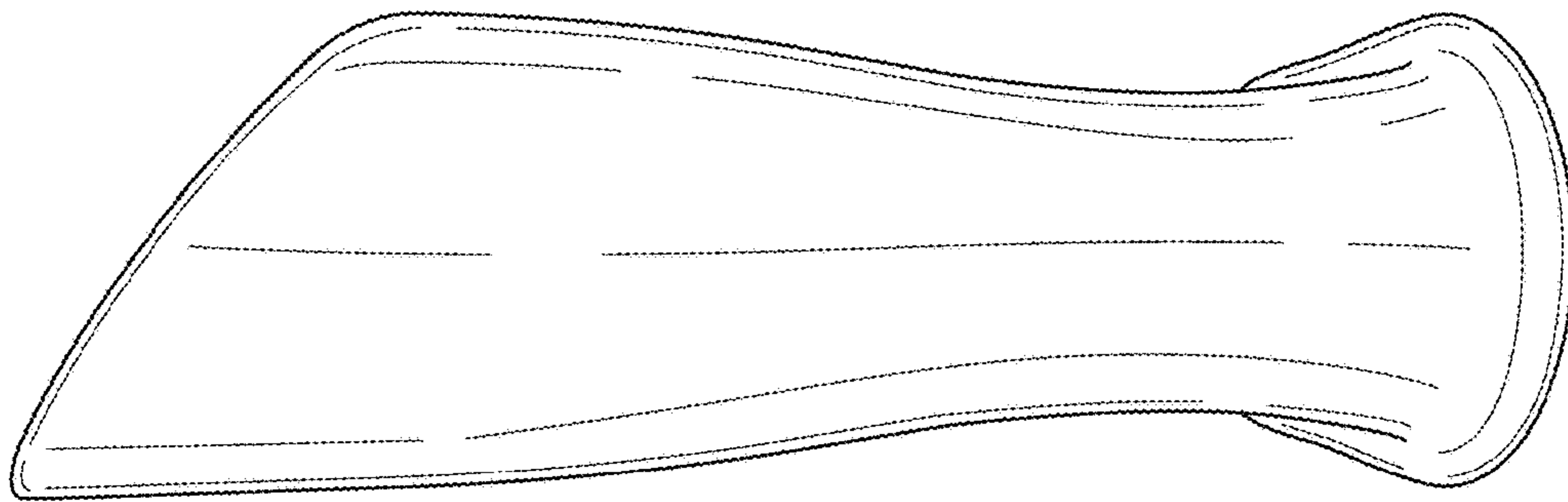

FIG. 4

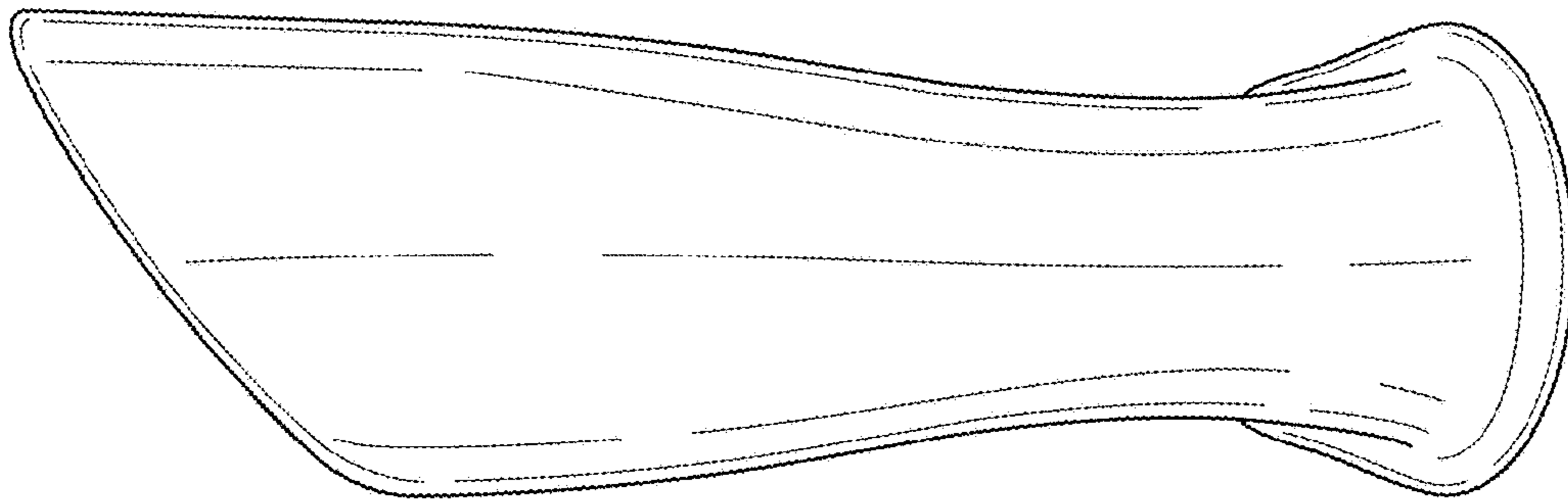

FIG. 5

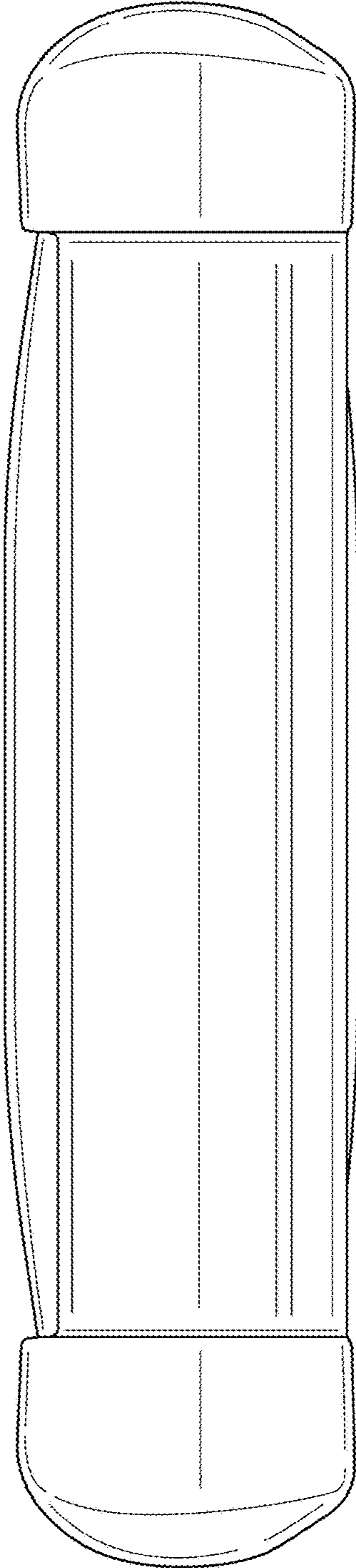

FIG. 6

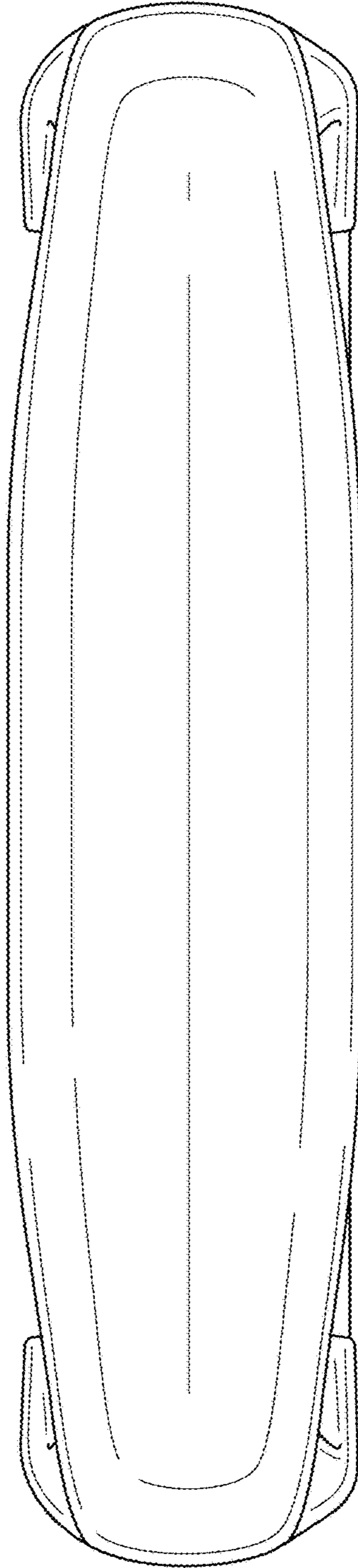

FIG. 7