



US00D854384S

(12) **United States Design Patent** (10) **Patent No.:** **US D854,384 S**  
**Saubert et al.** (45) **Date of Patent:** **\*\* Jul. 23, 2019**

(54) **EGG SEPARATOR** 5,784,953 A \* 7/1998 Wang ..... A47J 43/14  
 99/497  
 (71) Applicant: **TRANSFORM SR BRANDS LLC,** D413,492 S \* 9/1999 Wang ..... D7/667  
 Hoffman Estates, IL (US) D498,986 S \* 11/2004 So ..... D7/667  
 6,915,735 B1 \* 7/2005 So ..... A47J 43/14  
 99/497  
 (72) Inventors: **Michael Saubert,** Hoffman Estates, IL D571,165 S \* 6/2008 Silver ..... D7/667  
 (US); **Michael Seskauskas,** Lemont, IL 2012/0125210 A1 \* 5/2012 Myoung ..... A47J 43/14  
 (US); **Lori Wood,** Cary, IL (US) 99/497

(73) Assignee: **Transform SR Brands LLC,** Hoffman Estates, IL (US)

\* cited by examiner

(\*\*) Term: **15 Years**

*Primary Examiner* — Terry A Wallace

(21) Appl. No.: **29/648,576**

(74) *Attorney, Agent, or Firm* — McAndrews, Held & Malloy, Ltd.

(22) Filed: **May 22, 2018**

(57) **CLAIM**

(51) **LOC (11) Cl.** ..... **07-04**

The ornamental design for a egg separator, as shown and described.

(52) **U.S. Cl.**

**DESCRIPTION**

USPC ..... **D7/667**

(58) **Field of Classification Search**

USPC ..... D7/667, 668, 669, 368, 653–664, 642, D7/647

CPC ..... A47J 43/14; A23J 1/08; A23J 1/09

See application file for complete search history.

FIG. 1 is a top-front perspective view of a egg separator showing our new design;  
 FIG. 2 is a top plan view thereof;  
 FIG. 3 is a bottom plan view thereof;  
 FIG. 4 is a right side elevation view thereof;  
 FIG. 5 is a left side elevation thereof;  
 FIG. 6 is a front elevation view thereof;  
 FIG. 7 is a rear elevation view thereof; and,  
 FIG. 8 is a bottom-rear perspective view thereof.  
 The broken lines are unclaimed subject matter.

(56) **References Cited**

U.S. PATENT DOCUMENTS

2,035,065 A \* 3/1936 Gray ..... A47J 43/14  
 30/325  
 3,749,001 A \* 7/1973 Swett ..... A47J 43/14  
 99/499

**1 Claim, 5 Drawing Sheets**

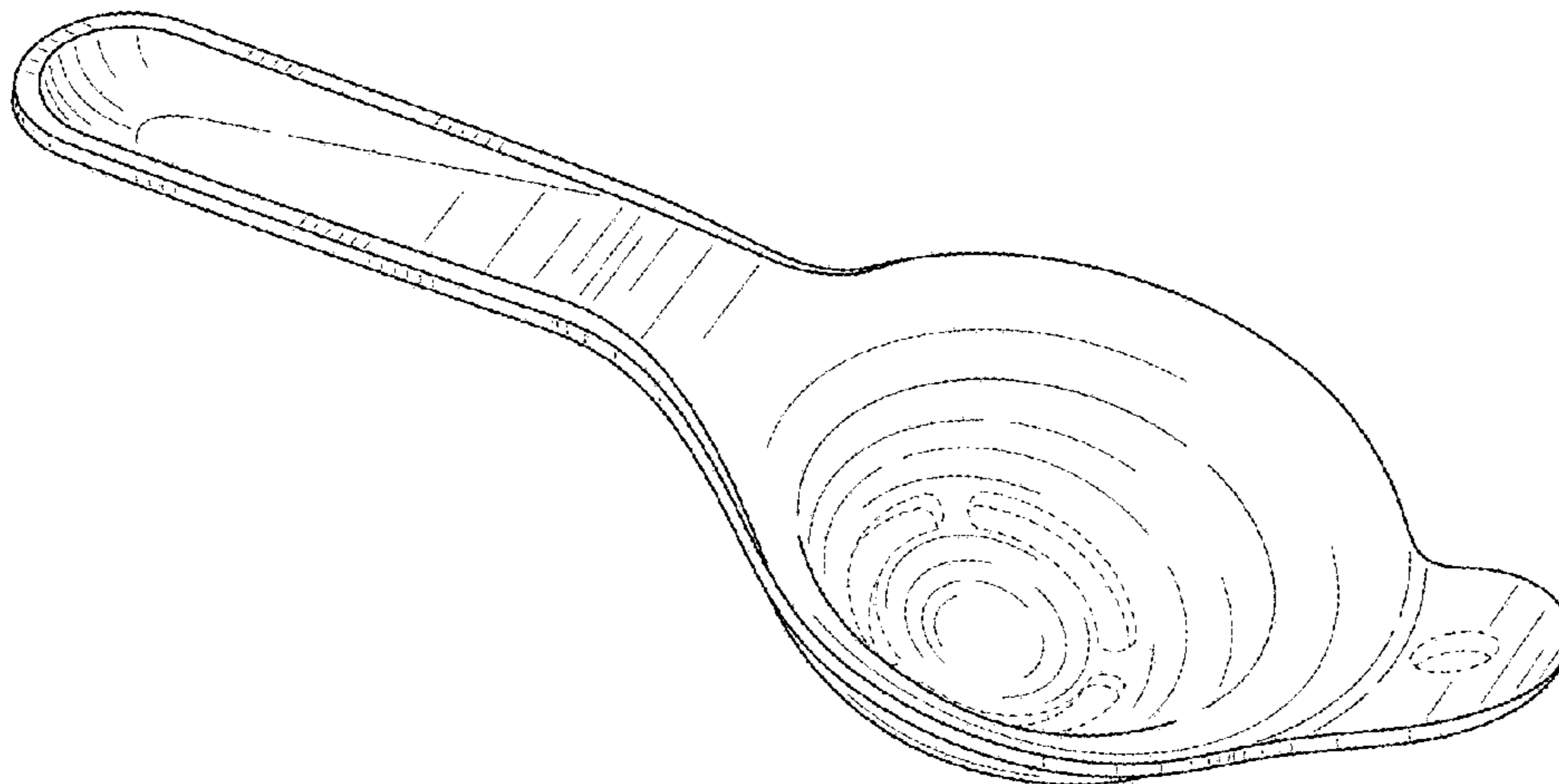

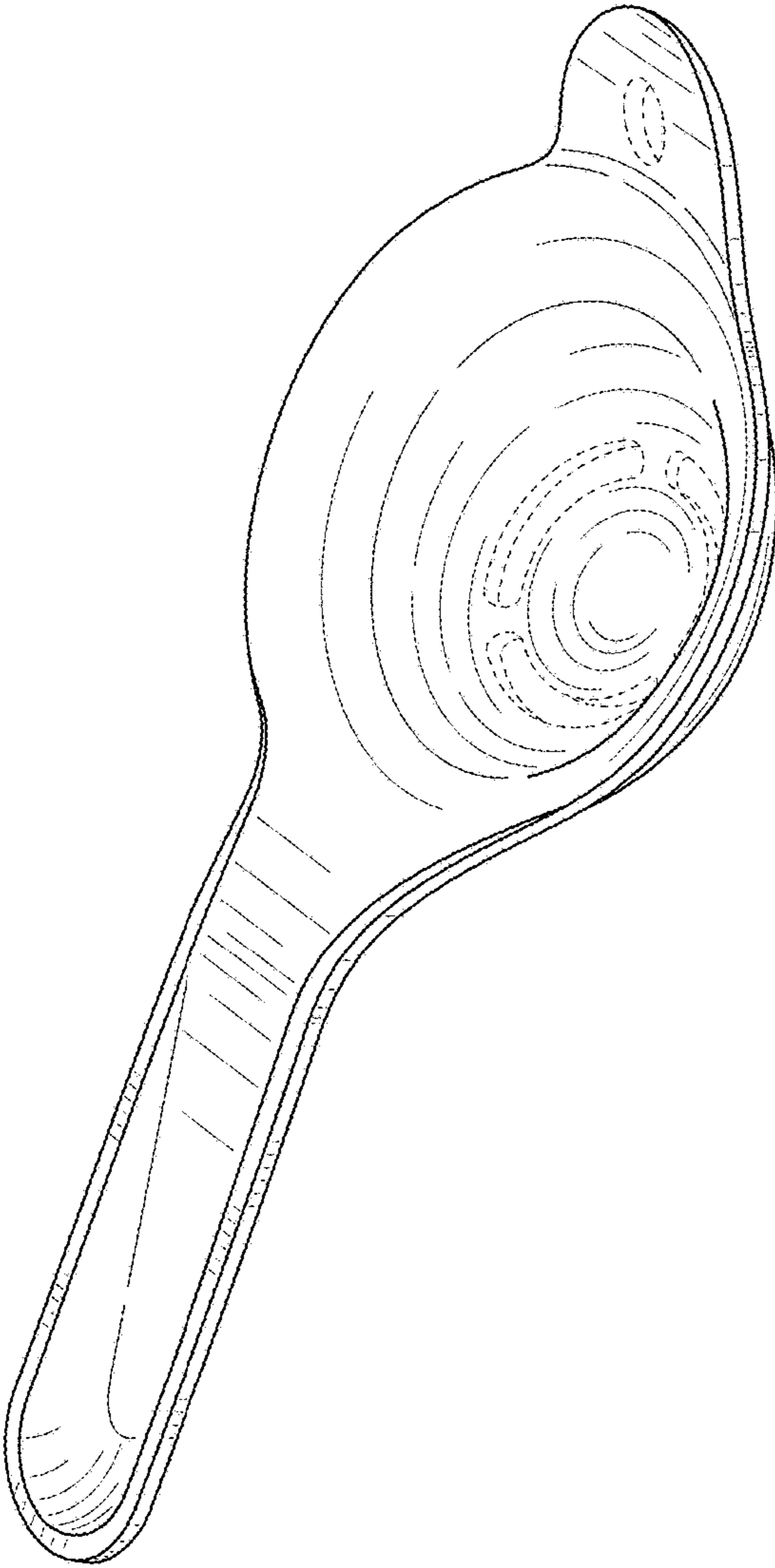

FIG. 1

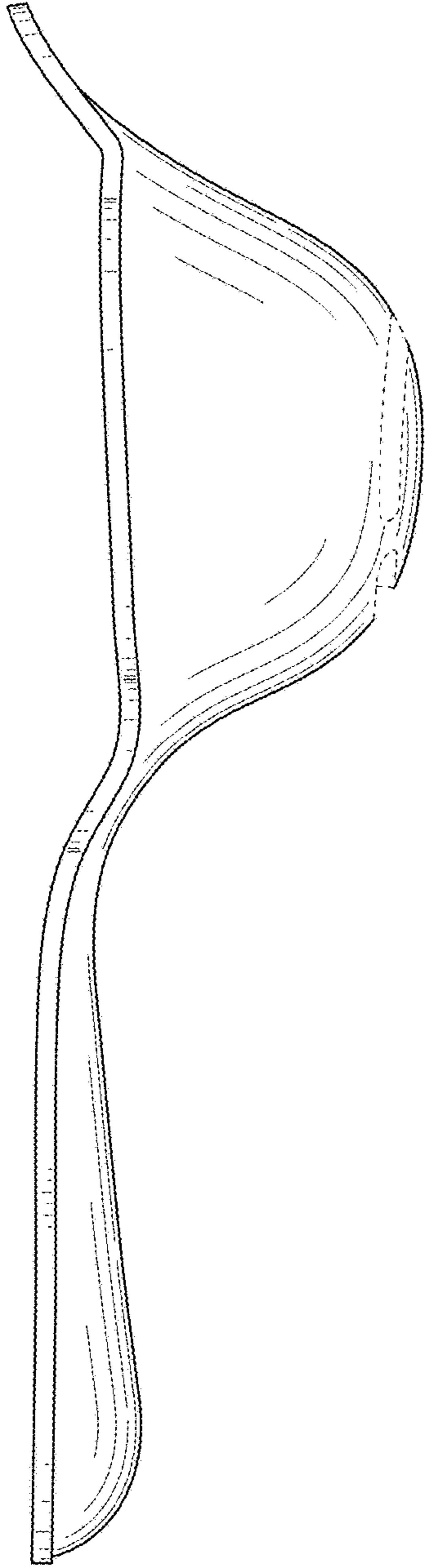

FIG. 2

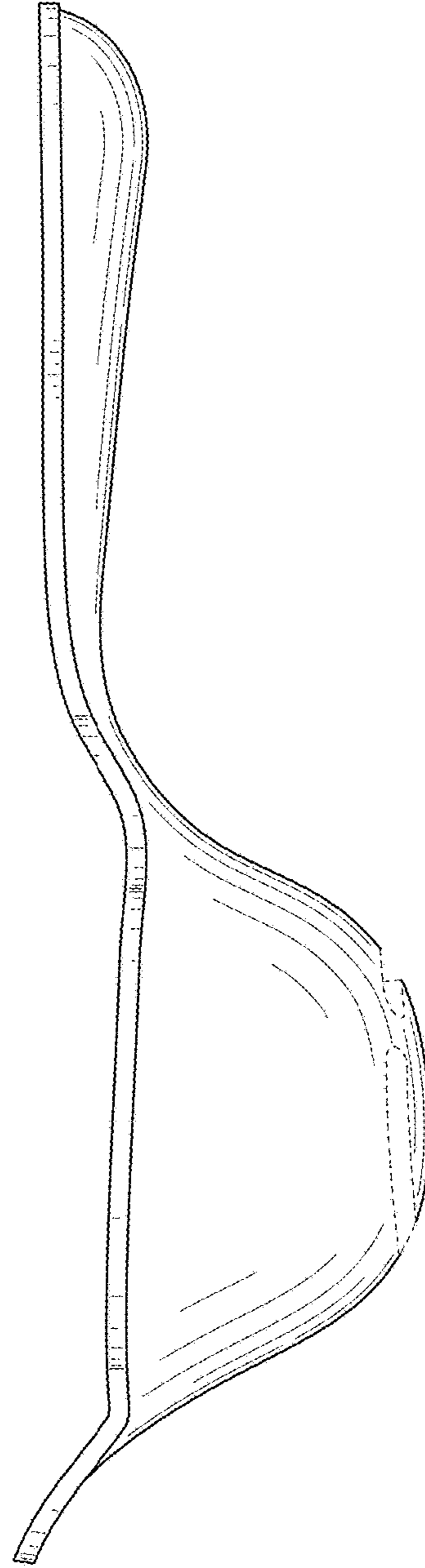

FIG. 3

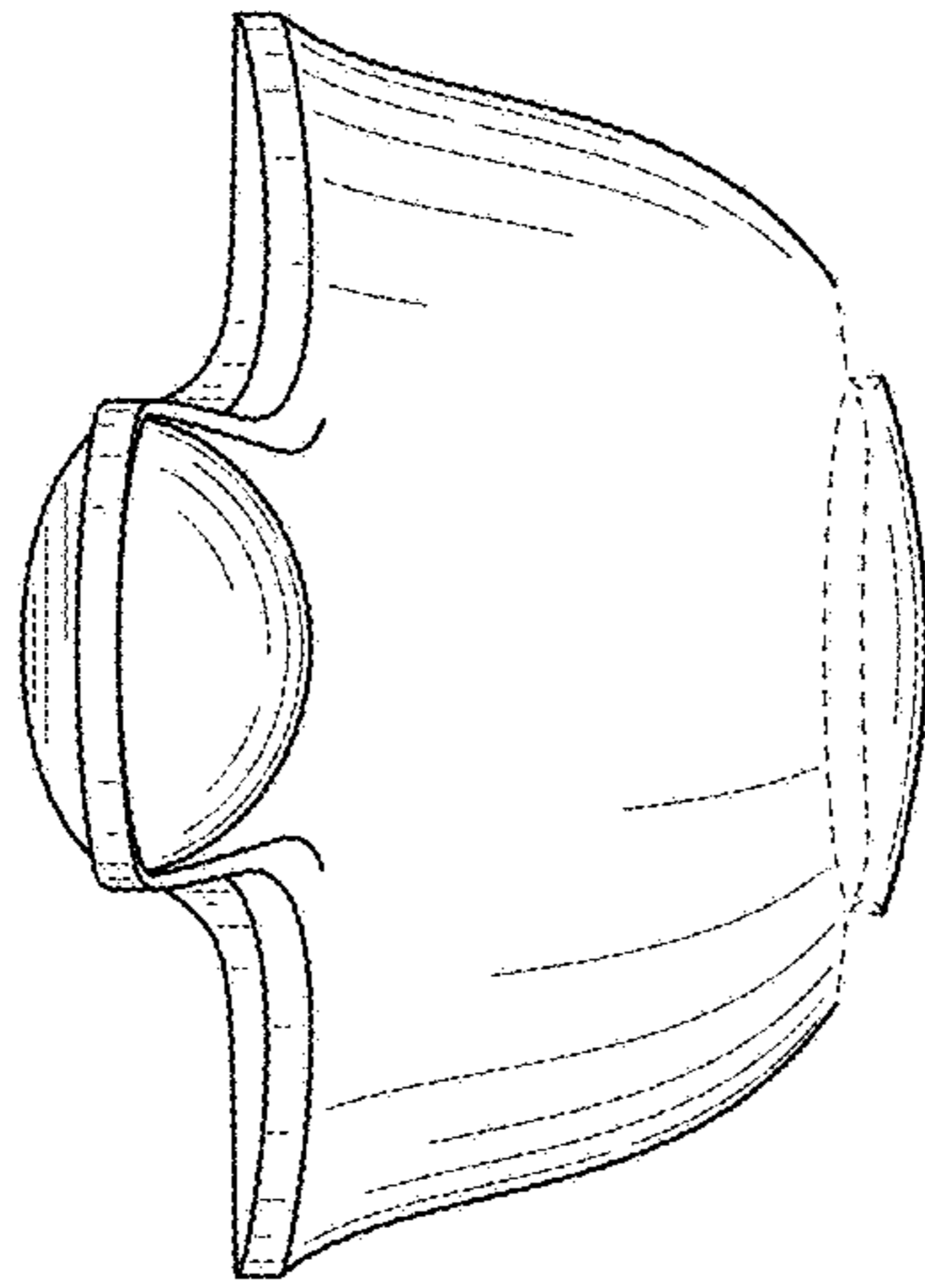

FIG. 5

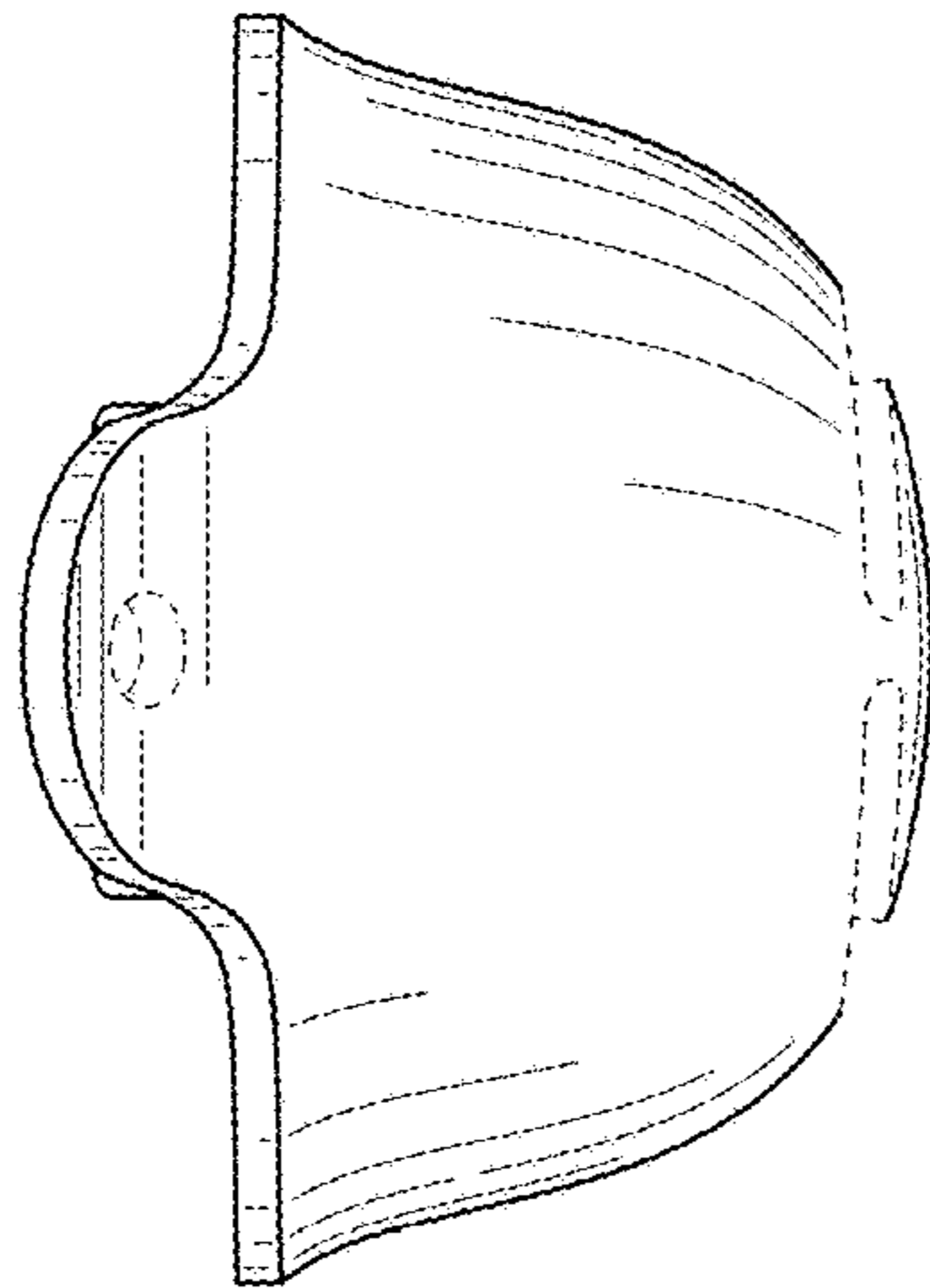
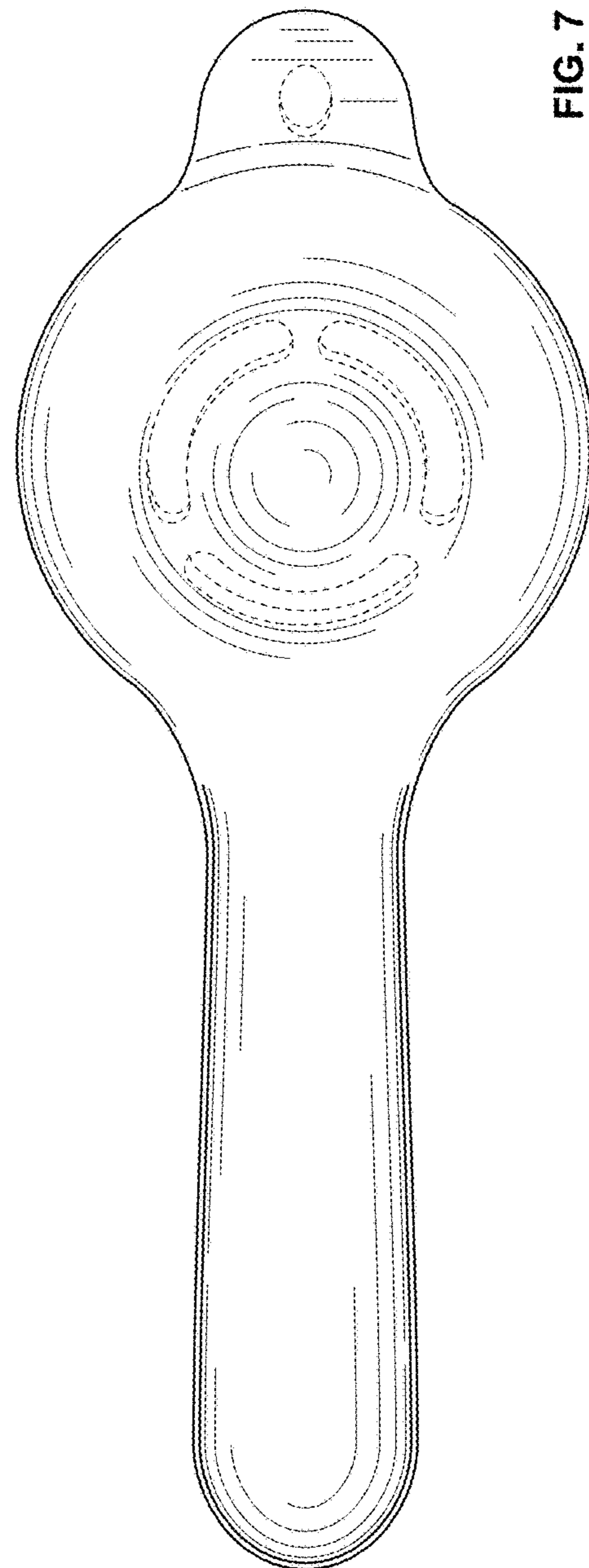
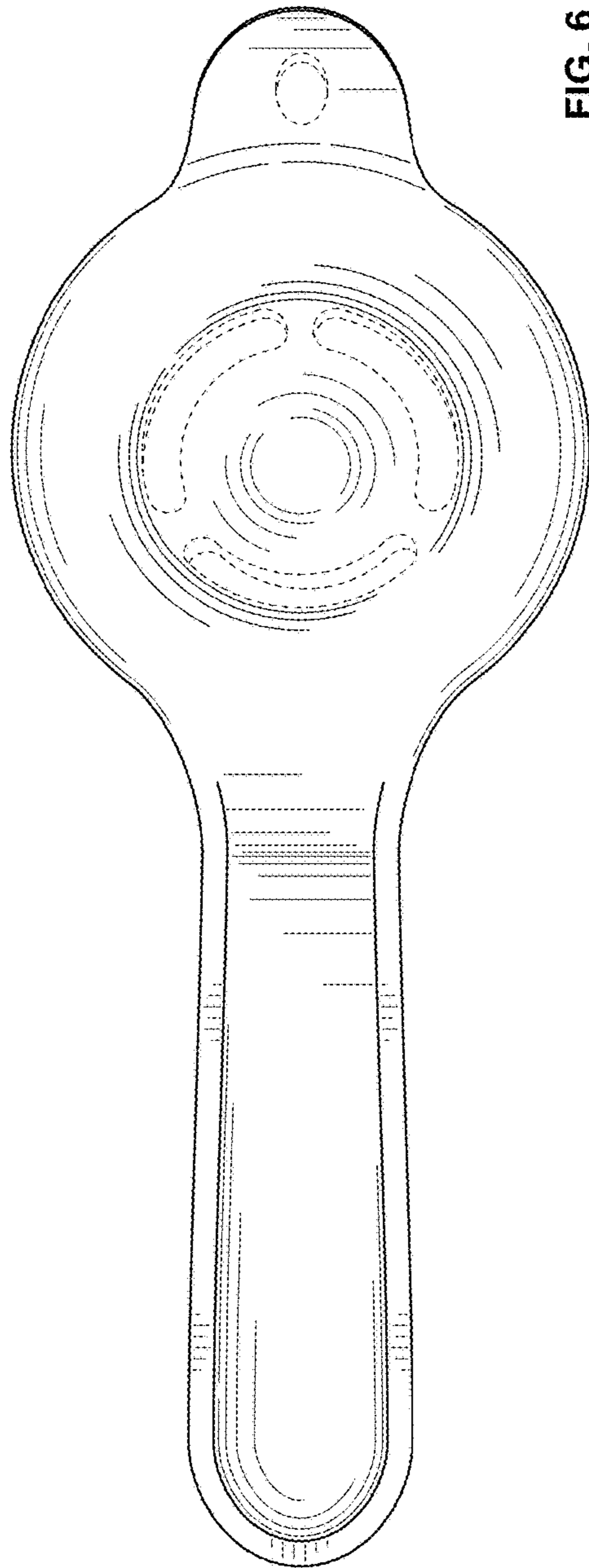

FIG. 4





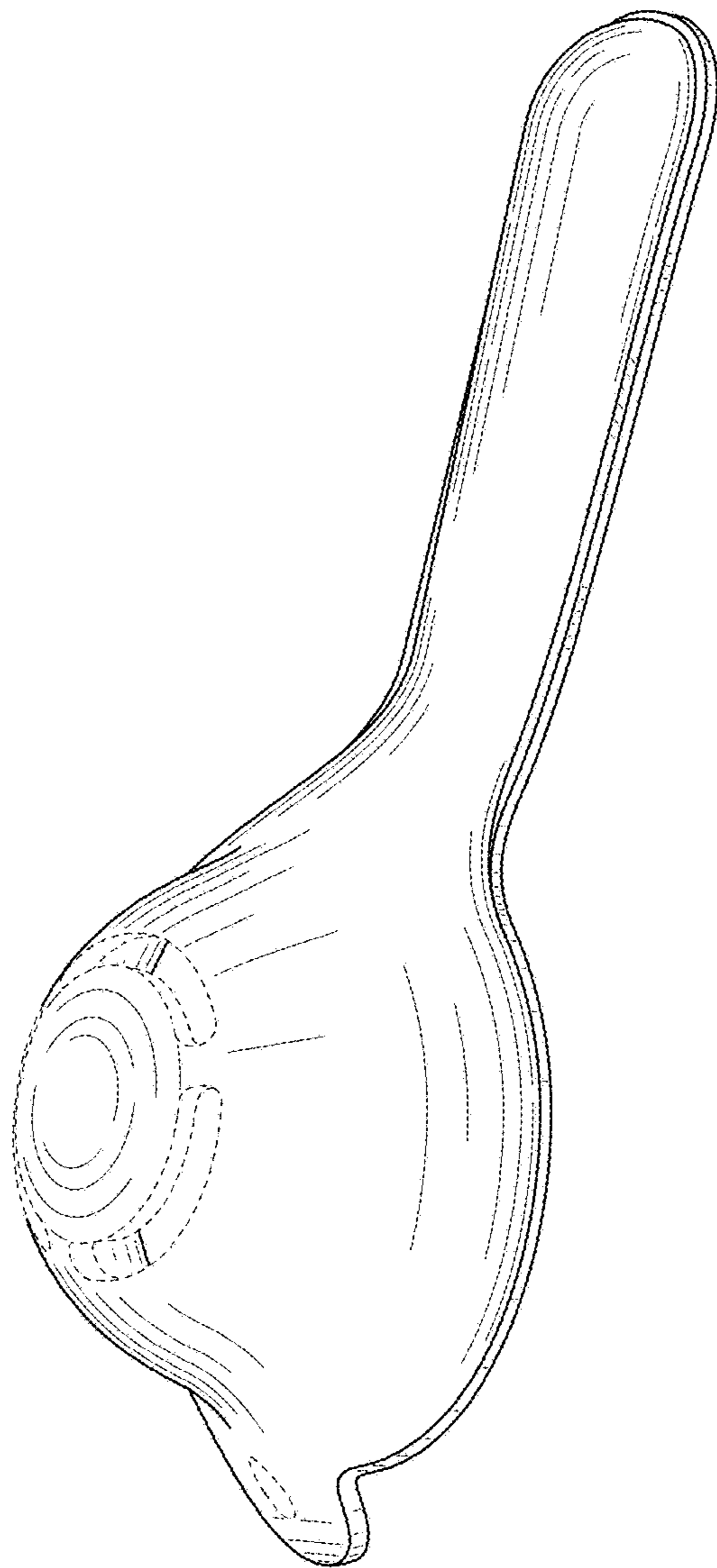

FIG. 8