



US00D854379S

(12) **United States Design Patent** (10) **Patent No.:** **US D854,379 S**
Frank et al. (45) **Date of Patent:** **** Jul. 23, 2019**

(54) **GARLIC TRAY**

(71) Applicant: **Spectrum Diversified Designs, LLC**,
Seattle, WA (US)

(72) Inventors: **Matthew Frank**, Seattle, WA (US);
Derek Veldkamp, Seattle, WA (US)

(73) Assignee: **Spectrum Diversified Designs, LLC**,
Streetsboro, OH (US)

(**) Term: **15 Years**

(21) Appl. No.: **29/627,531**

(22) Filed: **Nov. 28, 2017**

(51) **LOC (11) Cl.** **07-01**

(52) **U.S. Cl.**
USPC **D7/553.3**

(58) **Field of Classification Search**
USPC D7/550.1, 552.2, 553.1, 553.2, 553.3,
D7/553.5, 554.3, 601-602, 401.1;
D9/755-756, 759-761; D3/304, 313, 315
(Continued)

(56) **References Cited**

U.S. PATENT DOCUMENTS

4,807,776 A * 2/1989 Cortopassi B65D 1/24
220/23.83
D461,554 S * 8/2002 Lafond D24/227
(Continued)

Primary Examiner — Kelley A Donnelly

(74) *Attorney, Agent, or Firm* — Tucker Ellis LLP

(57) **CLAIM**

We claim as our invention the ornamental design for a garlic tray, as shown and described herein.

DESCRIPTION

FIG. 1 is a side, perspective, exploded view of a garlic tray having a lid portion, a middle portion, and a container portion;

FIG. 2 is a side view of the garlic tray with the lid, middle, and container portions nested, and the lid portion in a closed position;

FIG. 3 is a bottom view of the garlic tray with the lid, middle and container portions nested, and the lid portion in an open position;

FIG. 4 is a top, perspective view of the garlic tray with the lid, middle, and container portions nested, and the lid portion in an open position;

FIG. 5 is a side perspective view of the garlic tray with the lid, middle, and container portions nested, and the lid portion in an open position;

FIG. 6 is a top view of the garlic tray with the lid, middle, and container portions nested, and the lid portion in an open position;

FIG. 7 is a bottom view of the garlic tray with the lid, middle, and container portions nested, and the lid portion in an open position;

FIG. 8 is a side, exploded view of the garlic tray having a lid portion, a middle portion, and a container portion, and the lid portion in the open position;

FIG. 9 is an end, exploded view of the garlic tray having a lid portion, a middle portion, and a container portion, and the lid portion in the open position;

FIG. 10 is a top, perspective view of the lid portion in the open position;

FIG. 11 is a bottom, perspective view of the lid portion in the open position;

FIG. 12 is a top view of the lid portion in the open position;

FIG. 13 is a side view of the lid portion in the open position;

FIG. 14 is an end view of the lid portion in the open position;

FIG. 15 is a bottom view of the lid portion in the open position;

FIG. 16 is a perspective view of the middle portion;

FIG. 17 is a bottom, perspective view of the middle portion;

FIG. 18 is a top view of the middle portion;

FIG. 19 is a side view of the middle portion;

FIG. 20 is an end view of the middle portion;

FIG. 21 is a bottom view of middle portion;

FIG. 22 is a perspective view of the container portion;

FIG. 23 is a top view of the container portion;

FIG. 24 is a side view of the container portion;

FIG. 25 is an end view of the container portion; and,

FIG. 26 is a bottom view of the container portion.

1 Claim, 26 Drawing Sheets

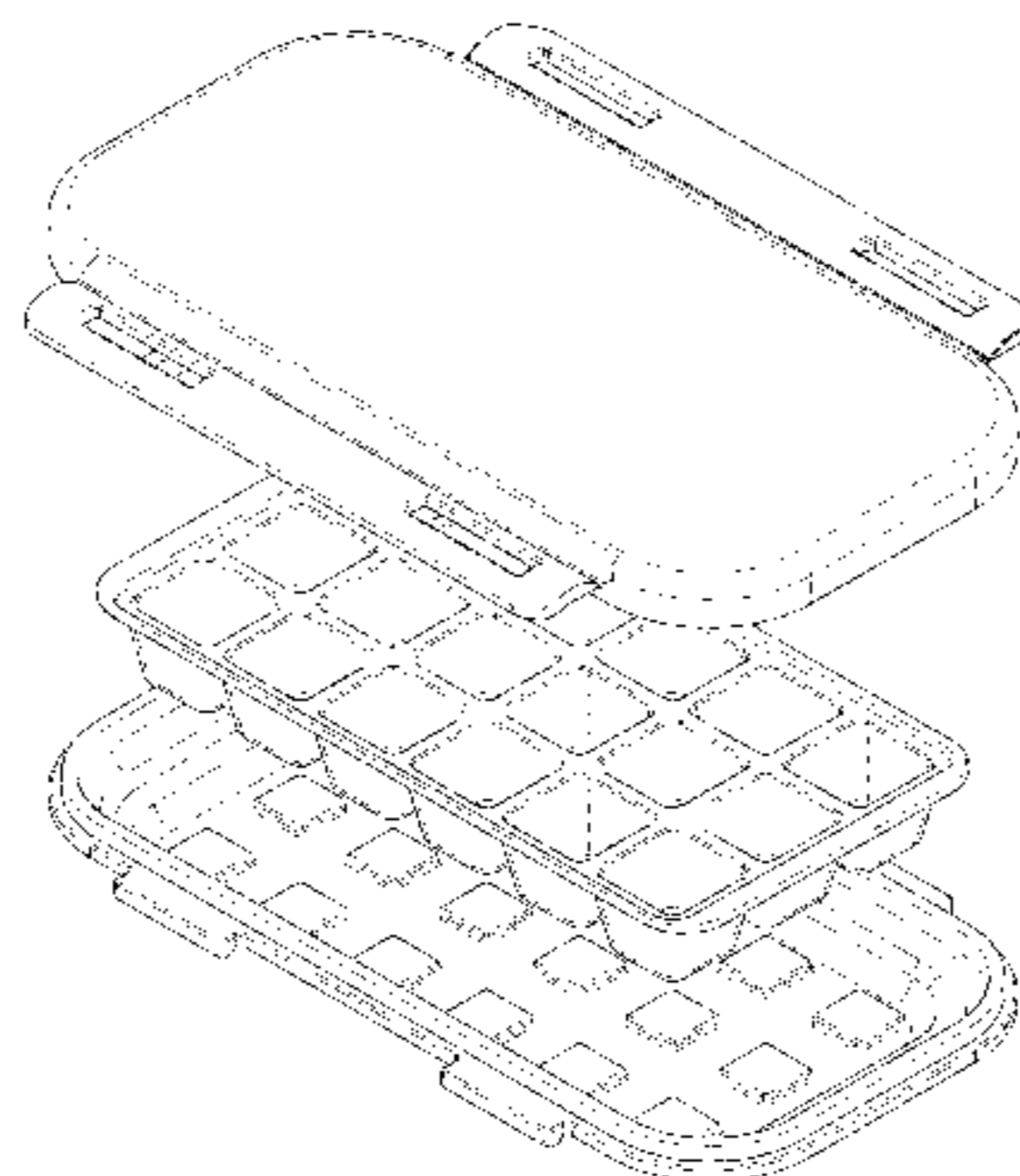

(58) **Field of Classification Search**

CPC B65D 1/243; B65D 2501/24019; B65D
2501/24165; B65D 11/18; B65D 85/30

See application file for complete search history.

(56) **References Cited**

U.S. PATENT DOCUMENTS

D632,803 S * 2/2011 Motadel D24/229
D635,364 S * 4/2011 Benetti D3/313
D699,370 S * 2/2014 Motadel D24/229
D724,236 S * 3/2015 Motadel D24/227
D730,127 S * 5/2015 Maxwell D7/629
9,108,201 B2 * 8/2015 Motadel B01L 9/543
D742,736 S * 11/2015 Snedden D9/418
D744,327 S * 12/2015 Snedden D9/418
D759,735 S * 6/2016 Tsai D15/90
D767,783 S * 9/2016 McClelland D24/227
D787,186 S * 5/2017 Thurbin D3/313
D798,165 S * 9/2017 Snedden D9/418
D804,324 S * 12/2017 Tayara D9/757
D836,989 S * 1/2019 Tang D7/553.2
D838,199 S * 1/2019 Wilson, II D10/82
D840,221 S * 2/2019 Lam D9/423
D844,428 S * 4/2019 Stadelmaier D9/415
2011/0236278 A1 * 9/2011 Motadel B01L 9/543
422/560

* cited by examiner

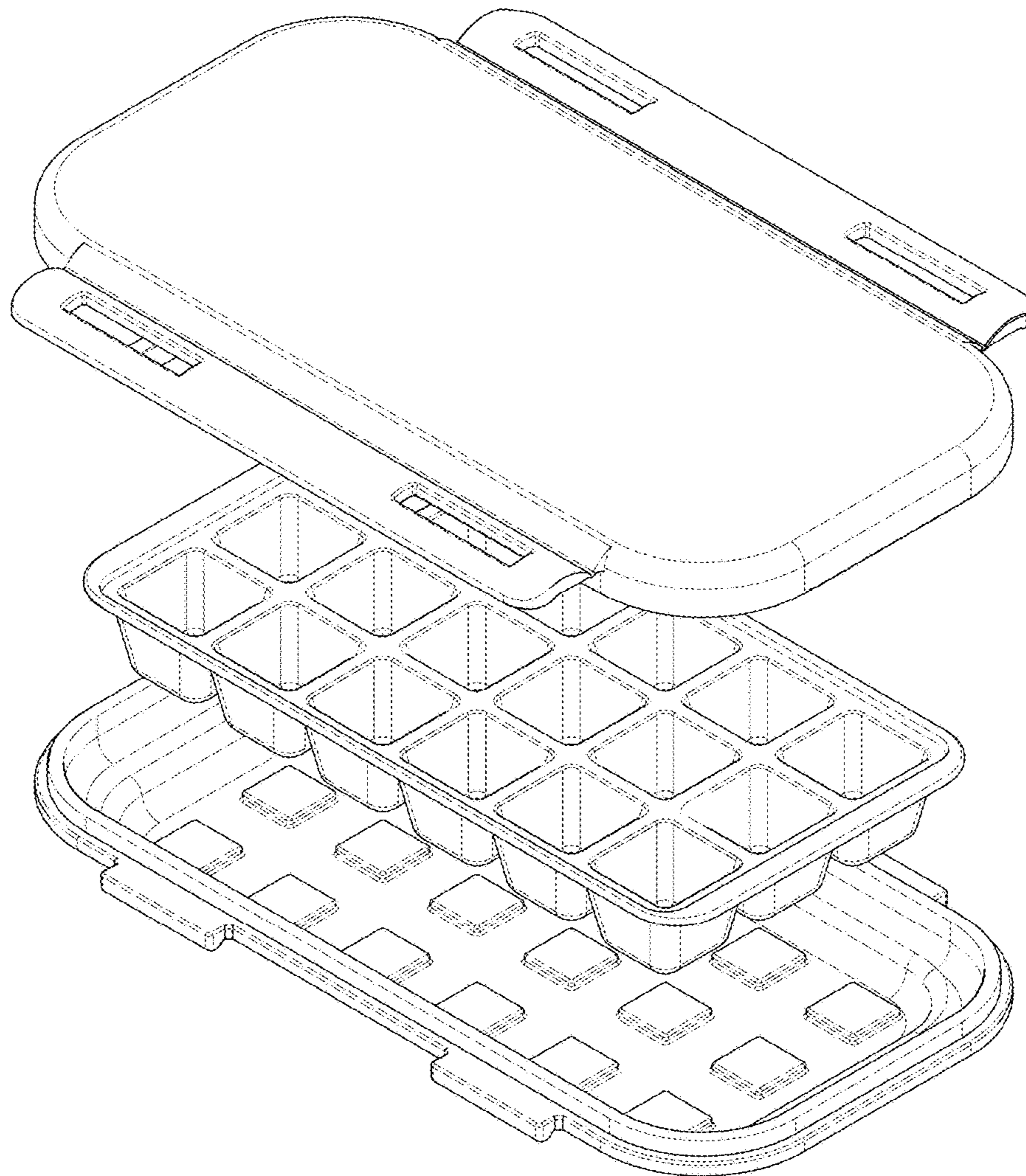

FIG. 1

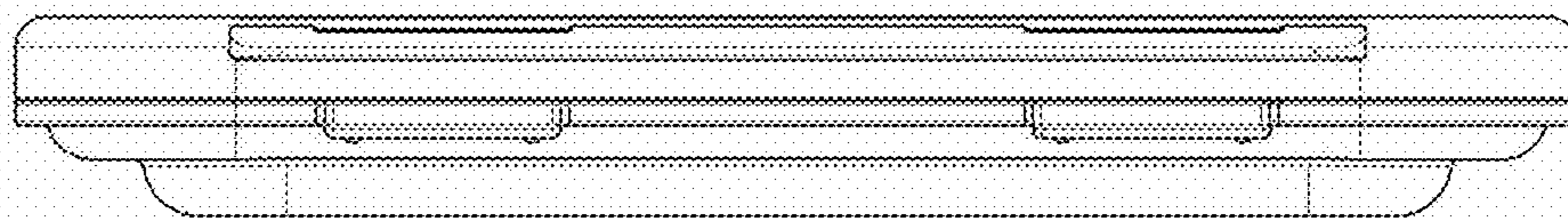

FIG. 2

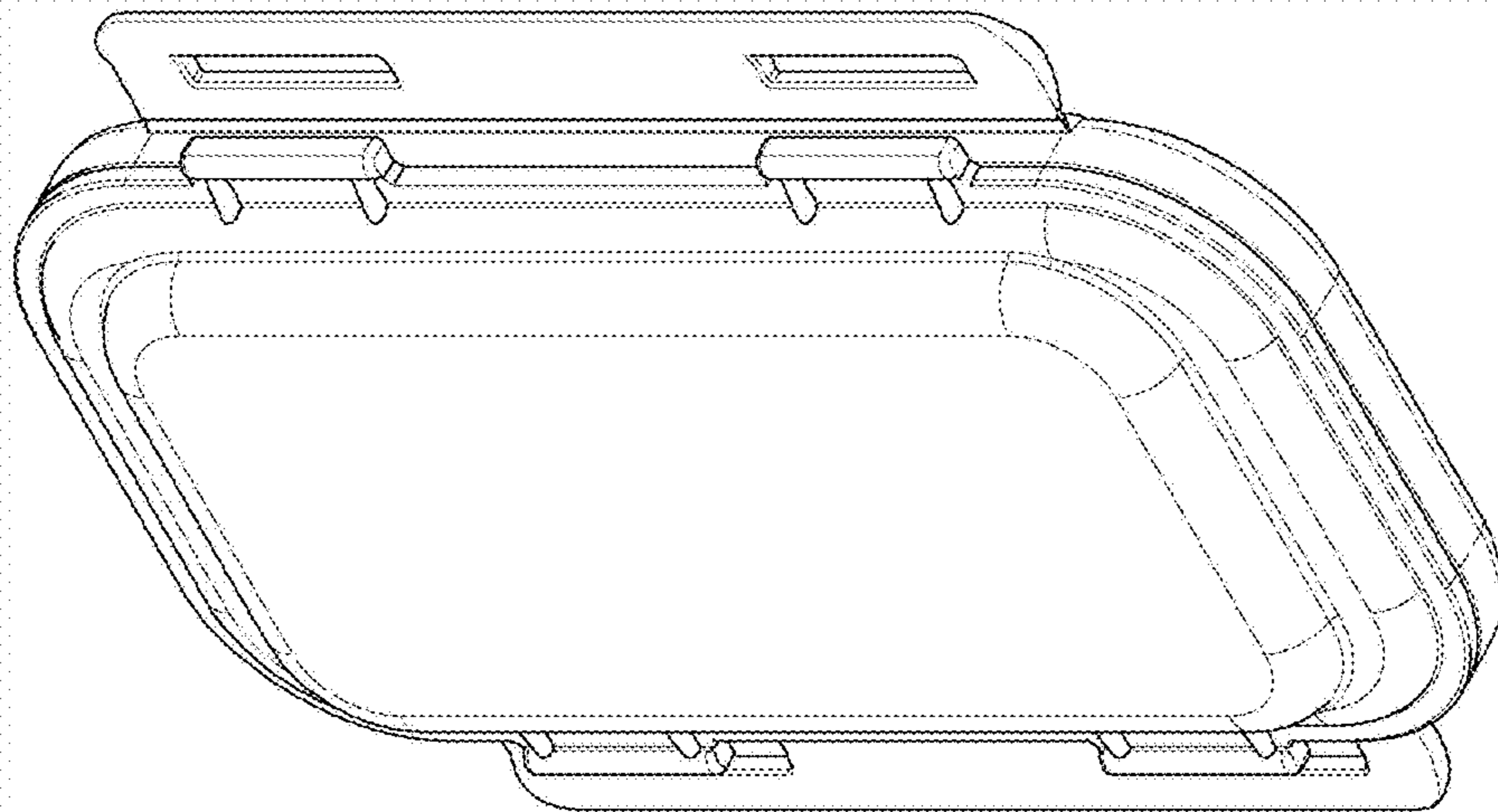

FIG. 3

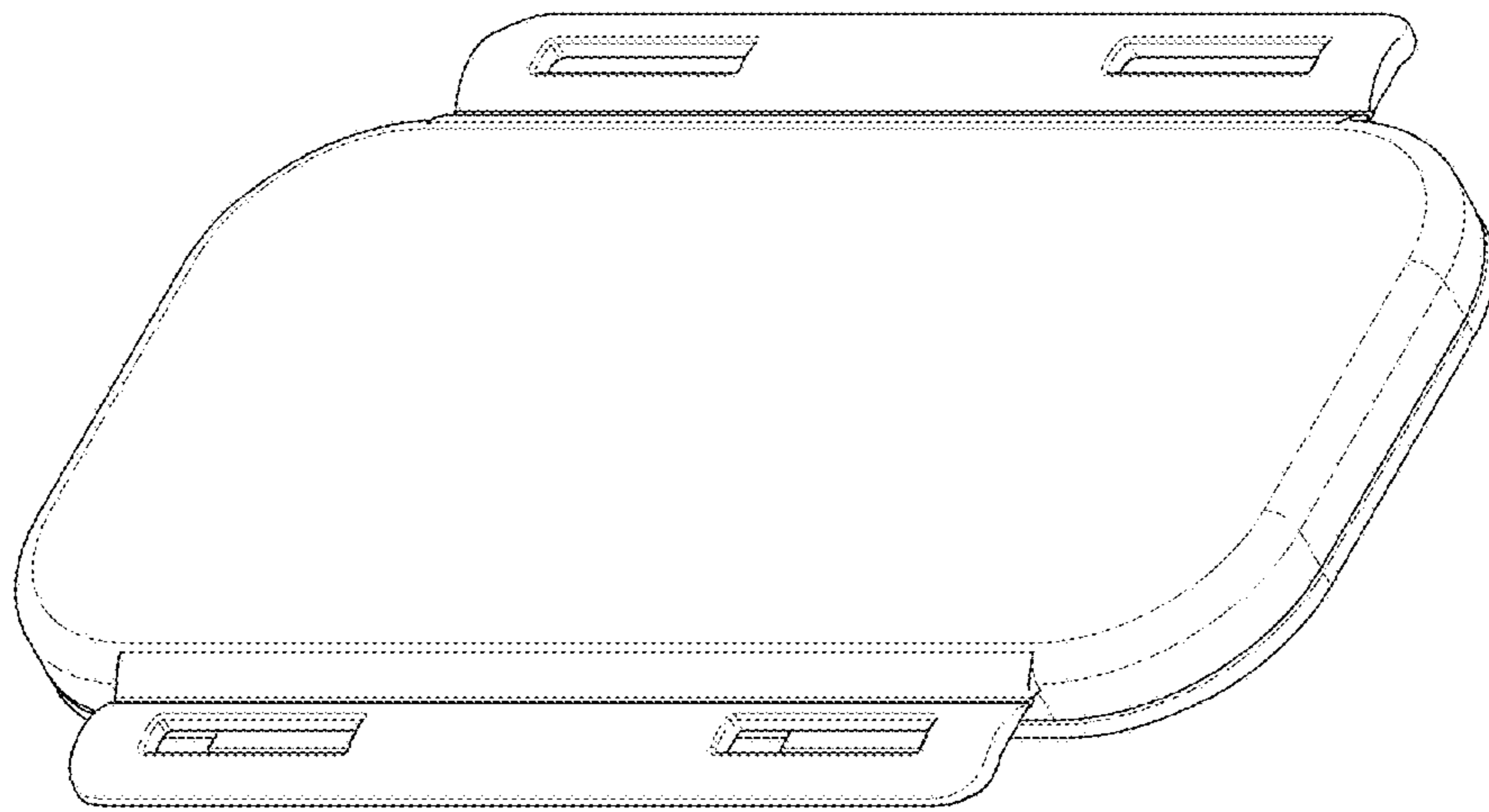

FIG. 4

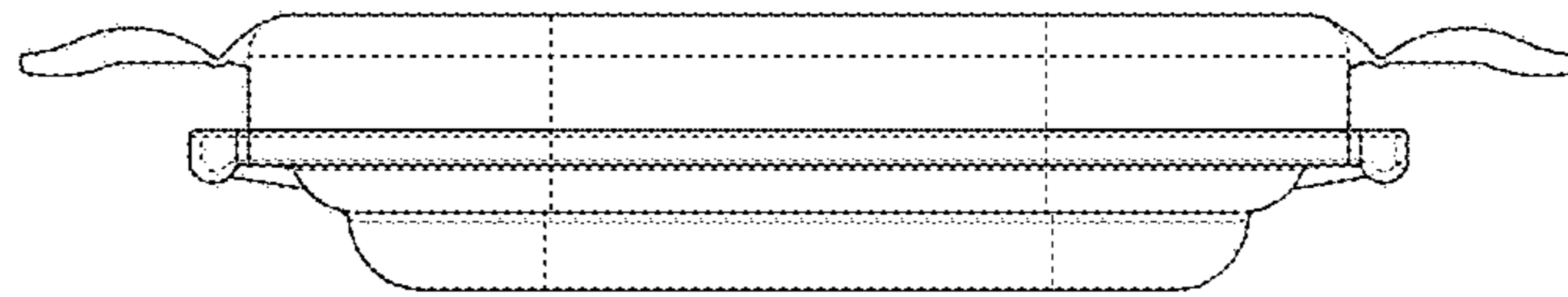

FIG. 5

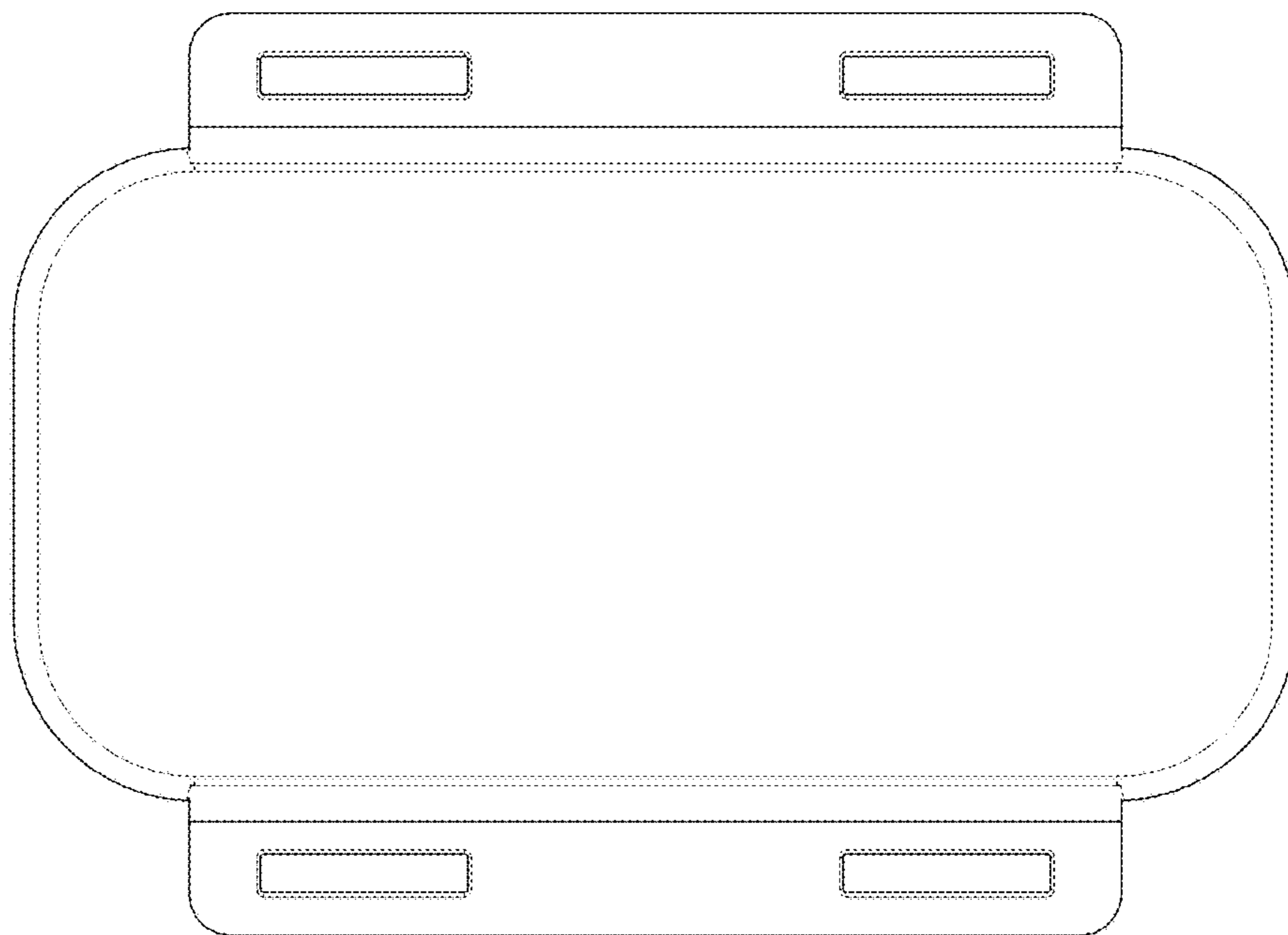

FIG. 6

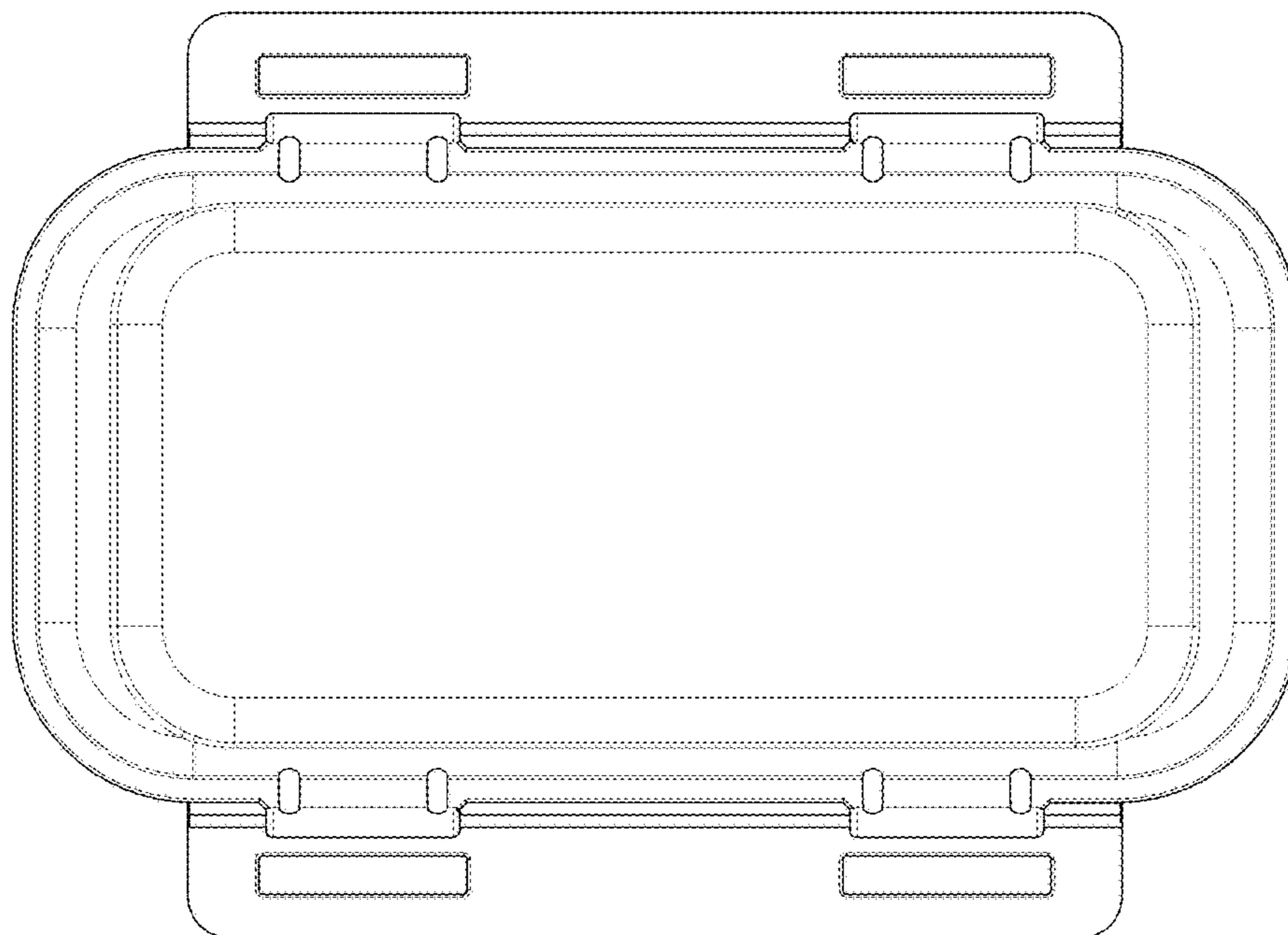

FIG. 7

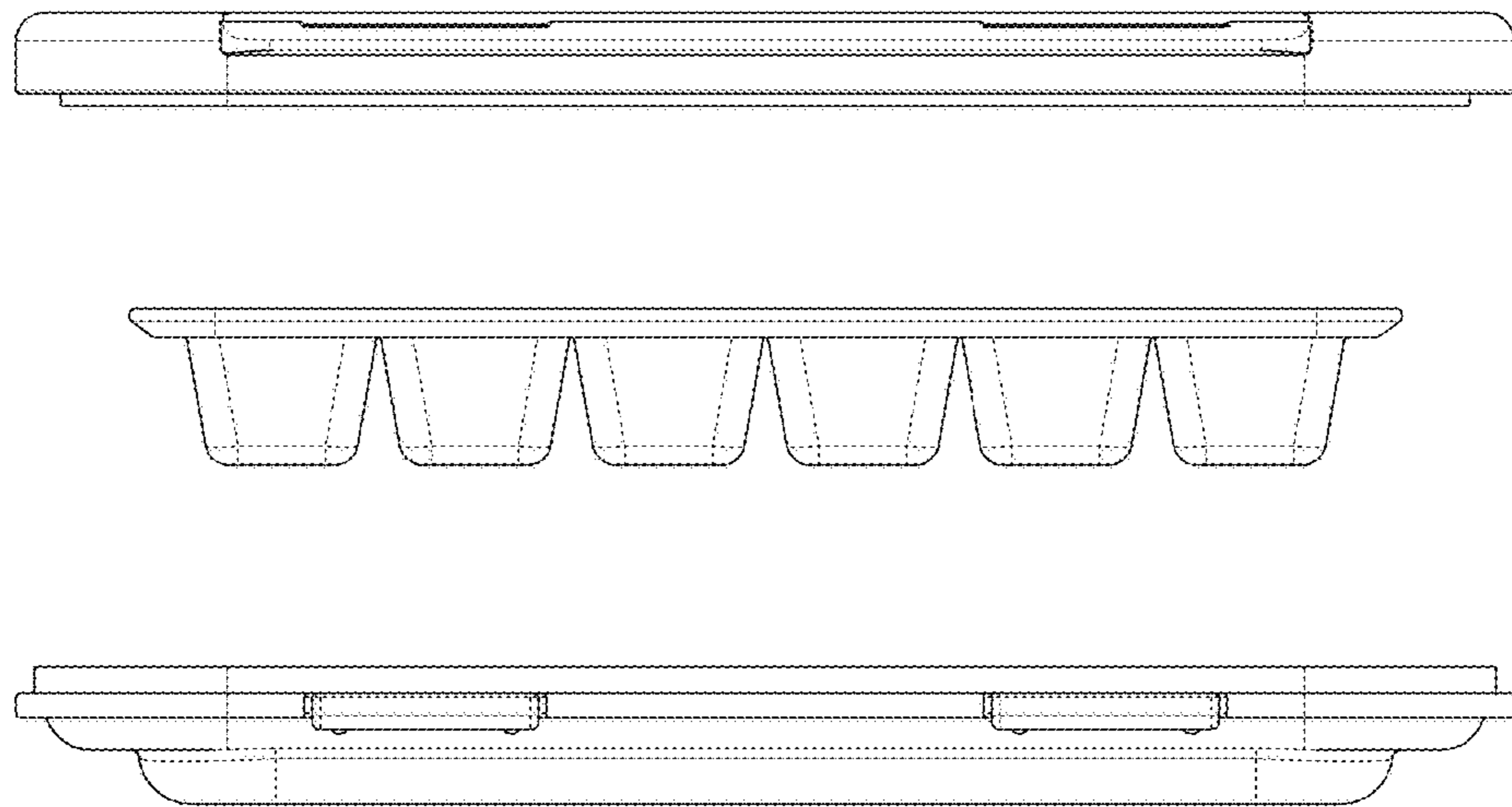

FIG. 8

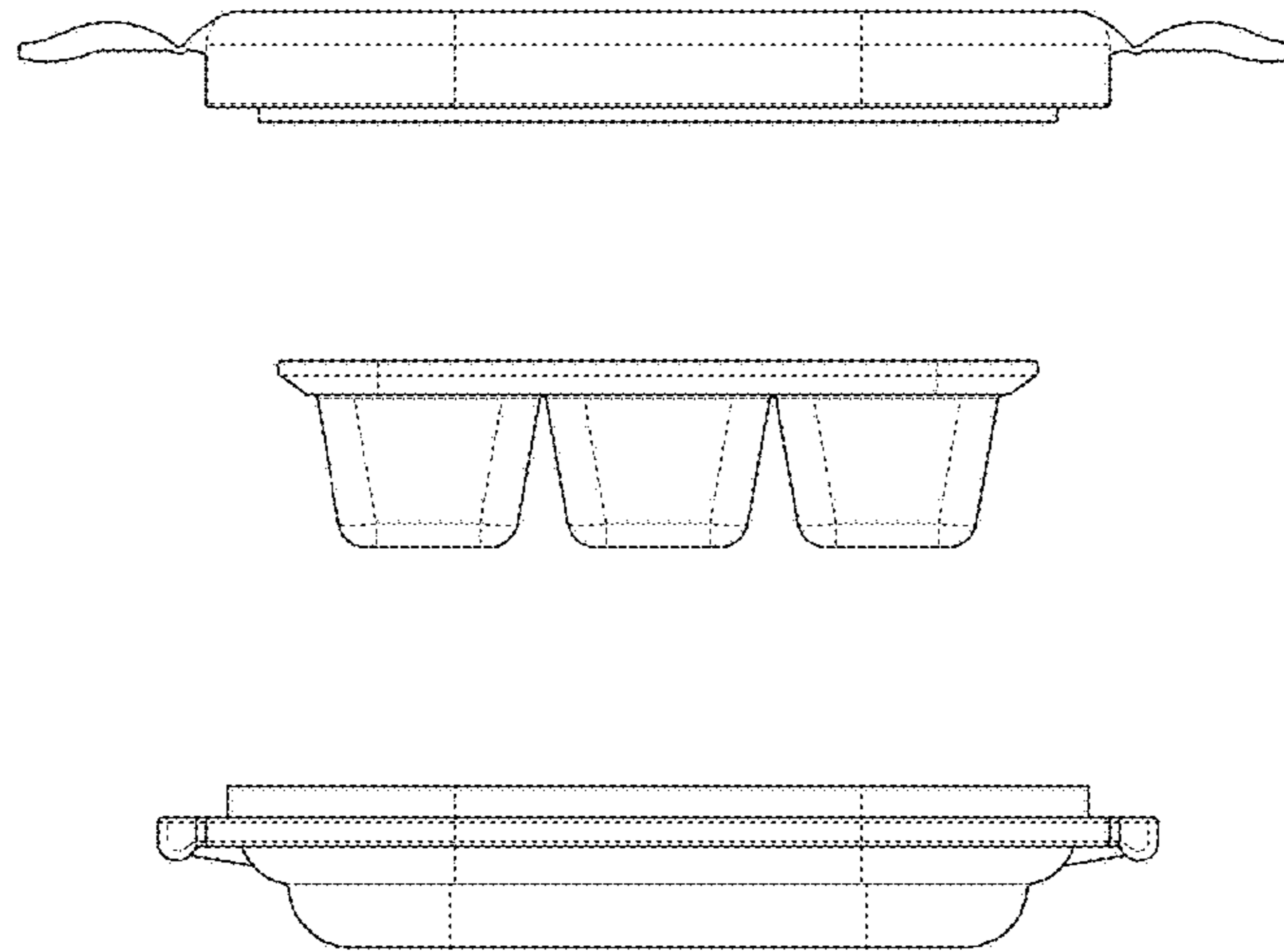

FIG. 9

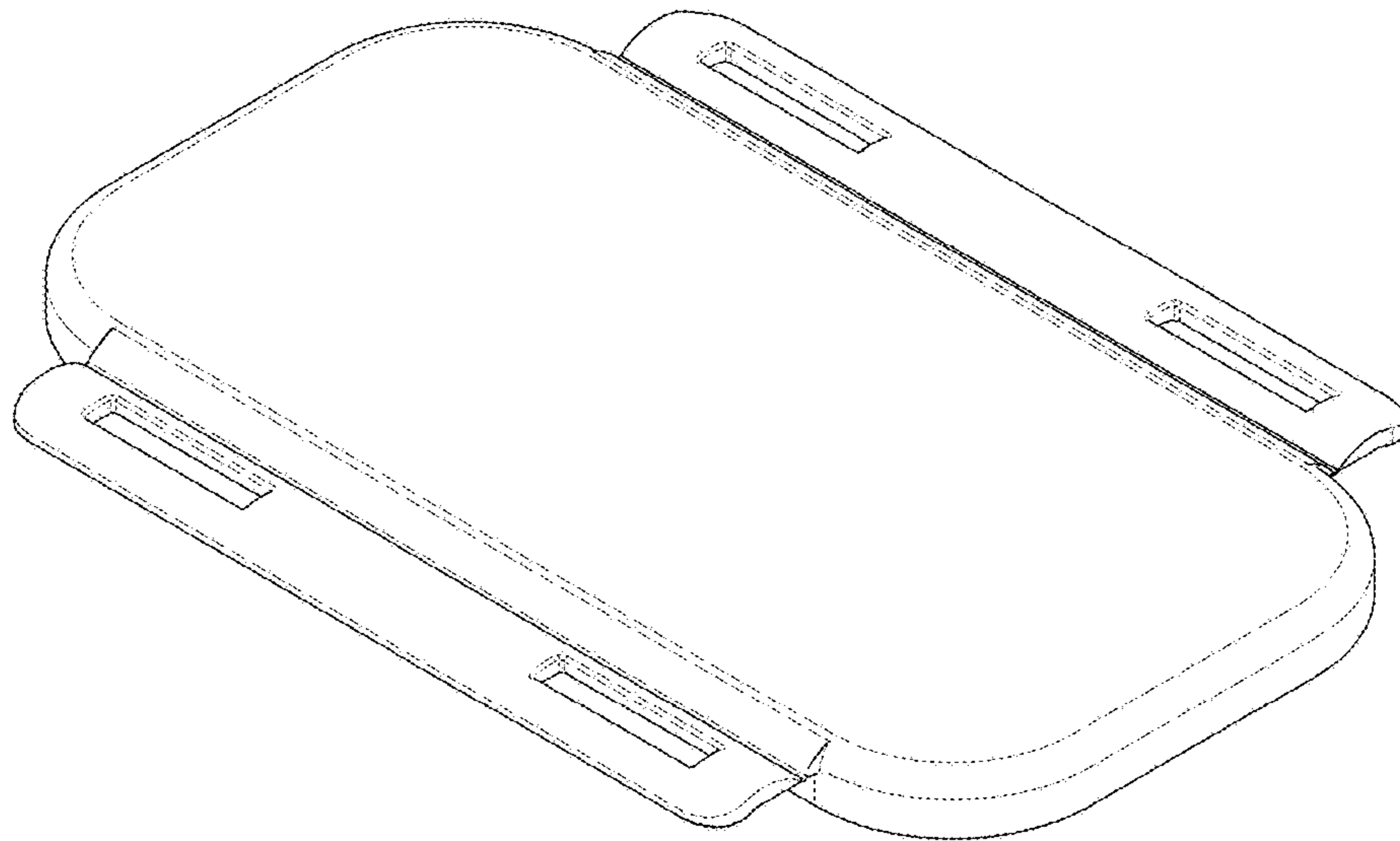

FIG. 10

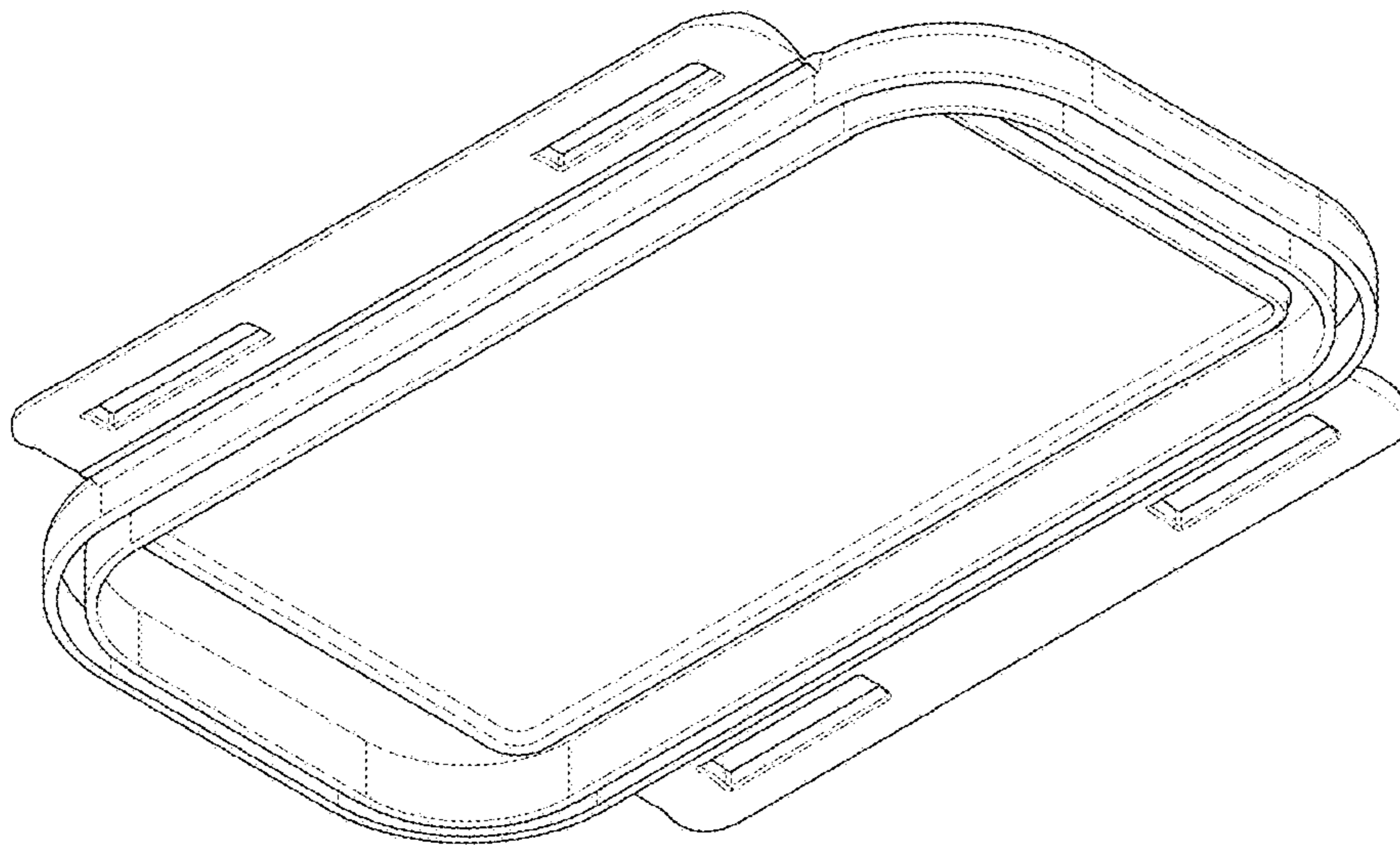

FIG. 11

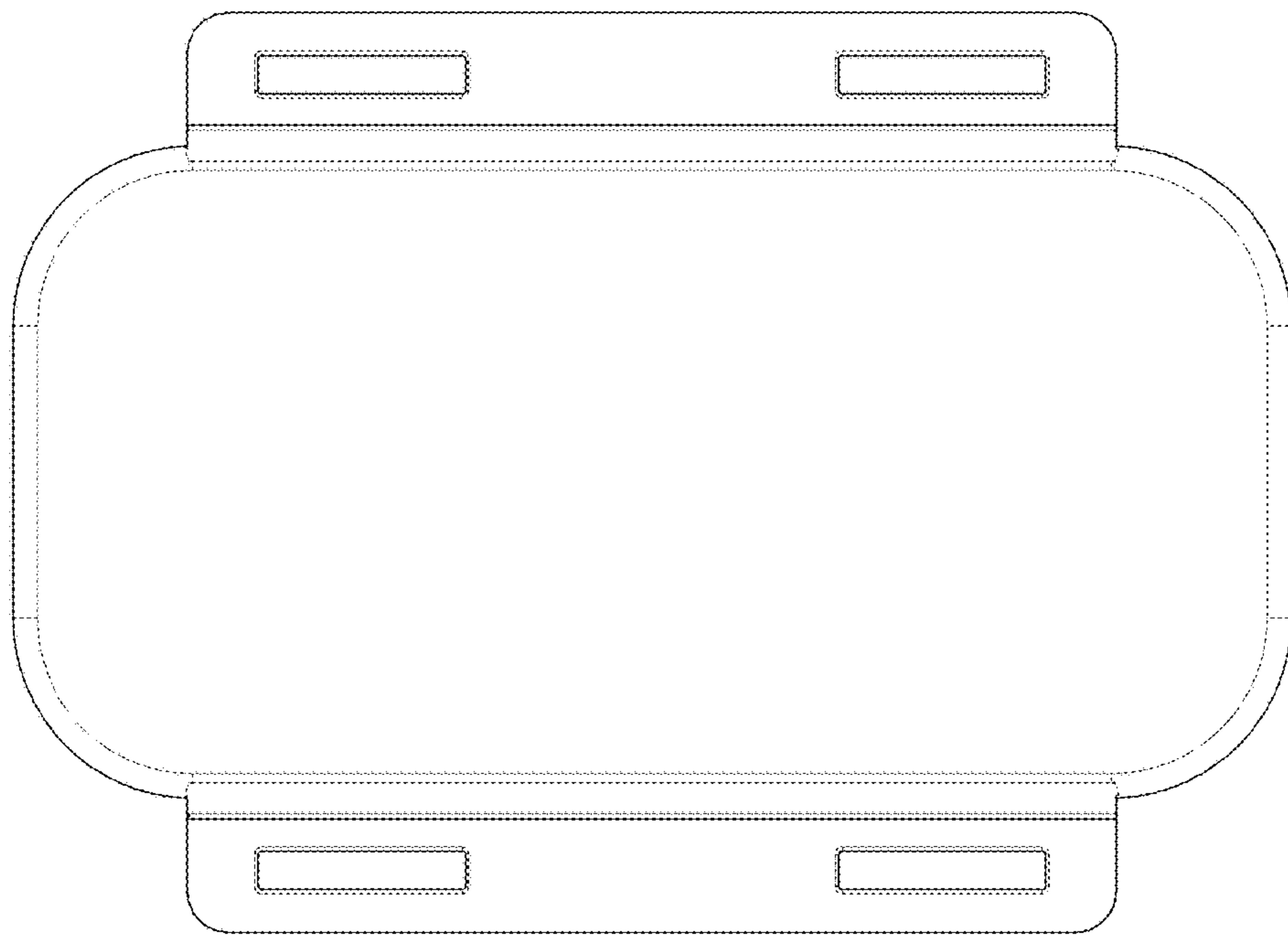

FIG. 12

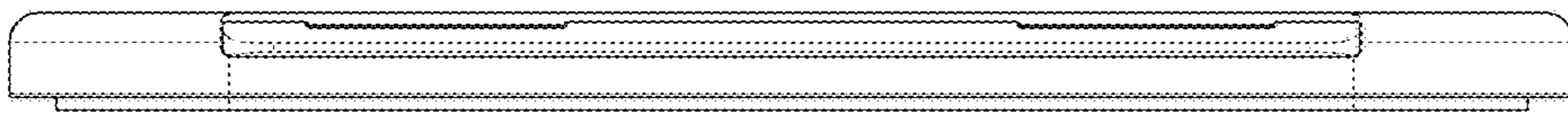

FIG. 13

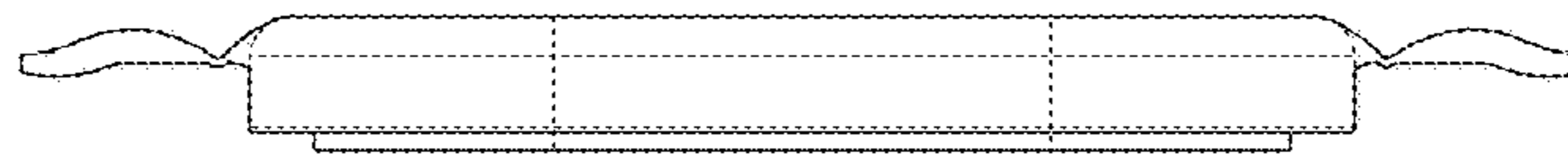

FIG. 14

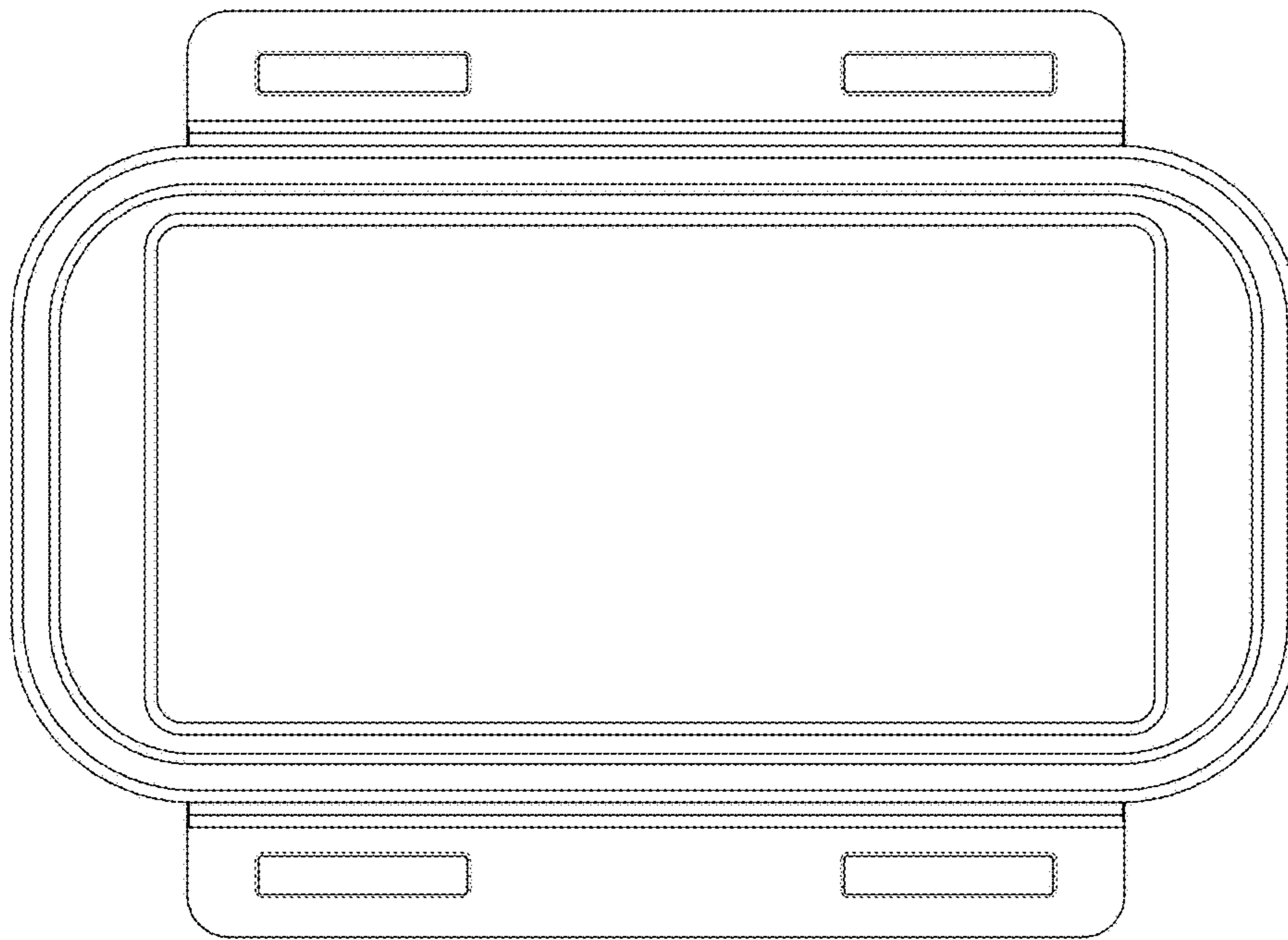

FIG. 15

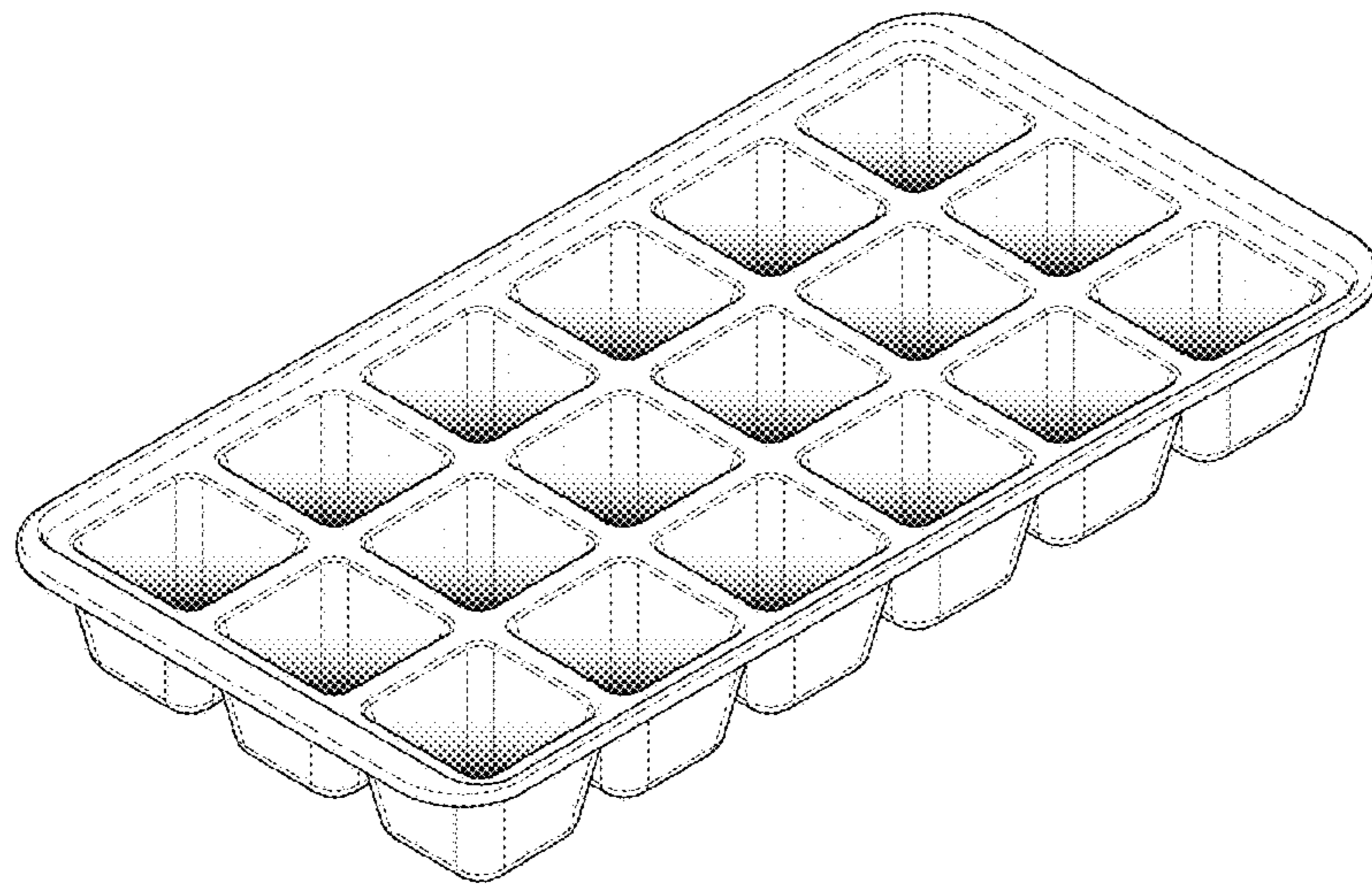

FIG. 16

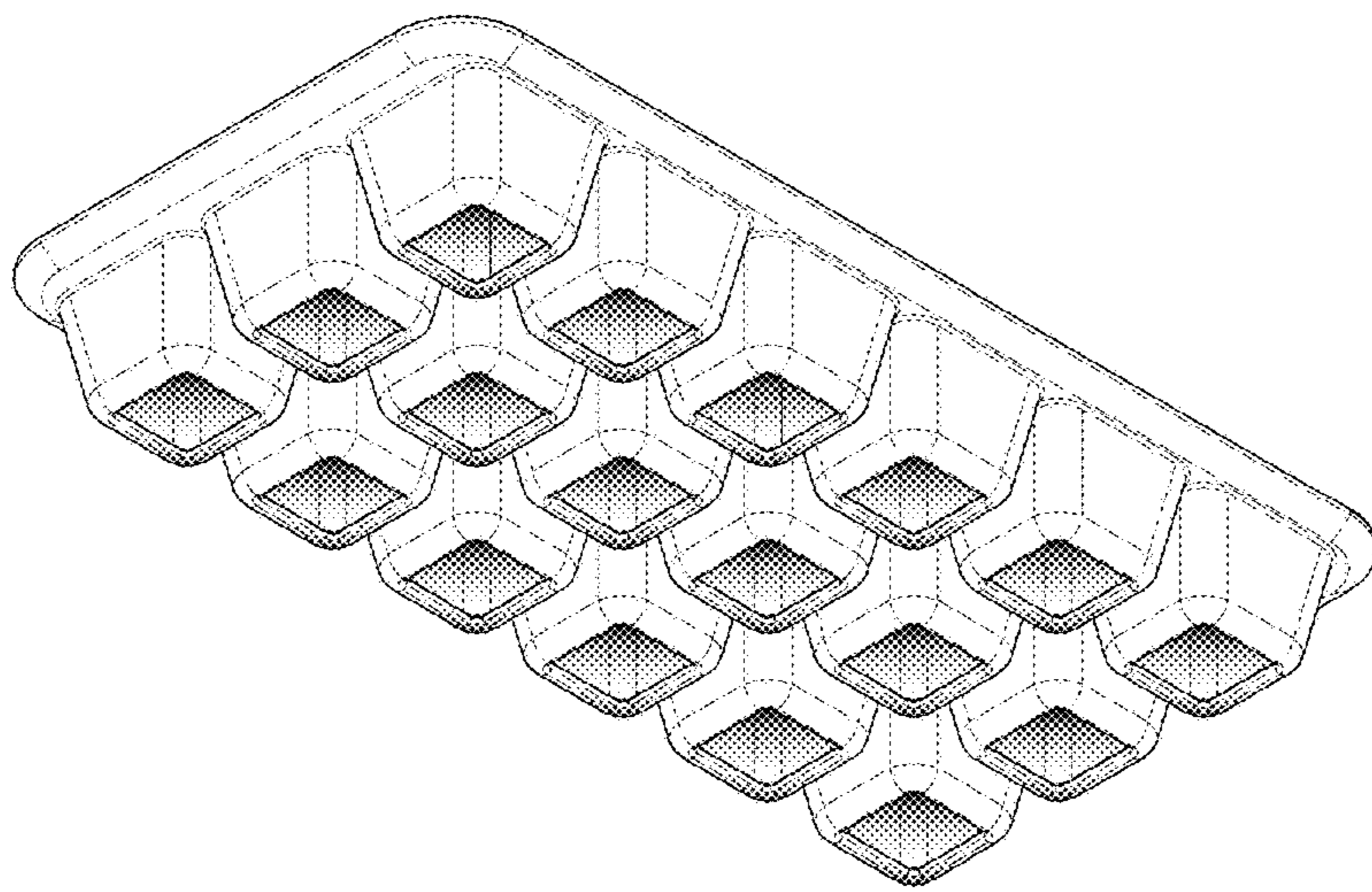

FIG. 17

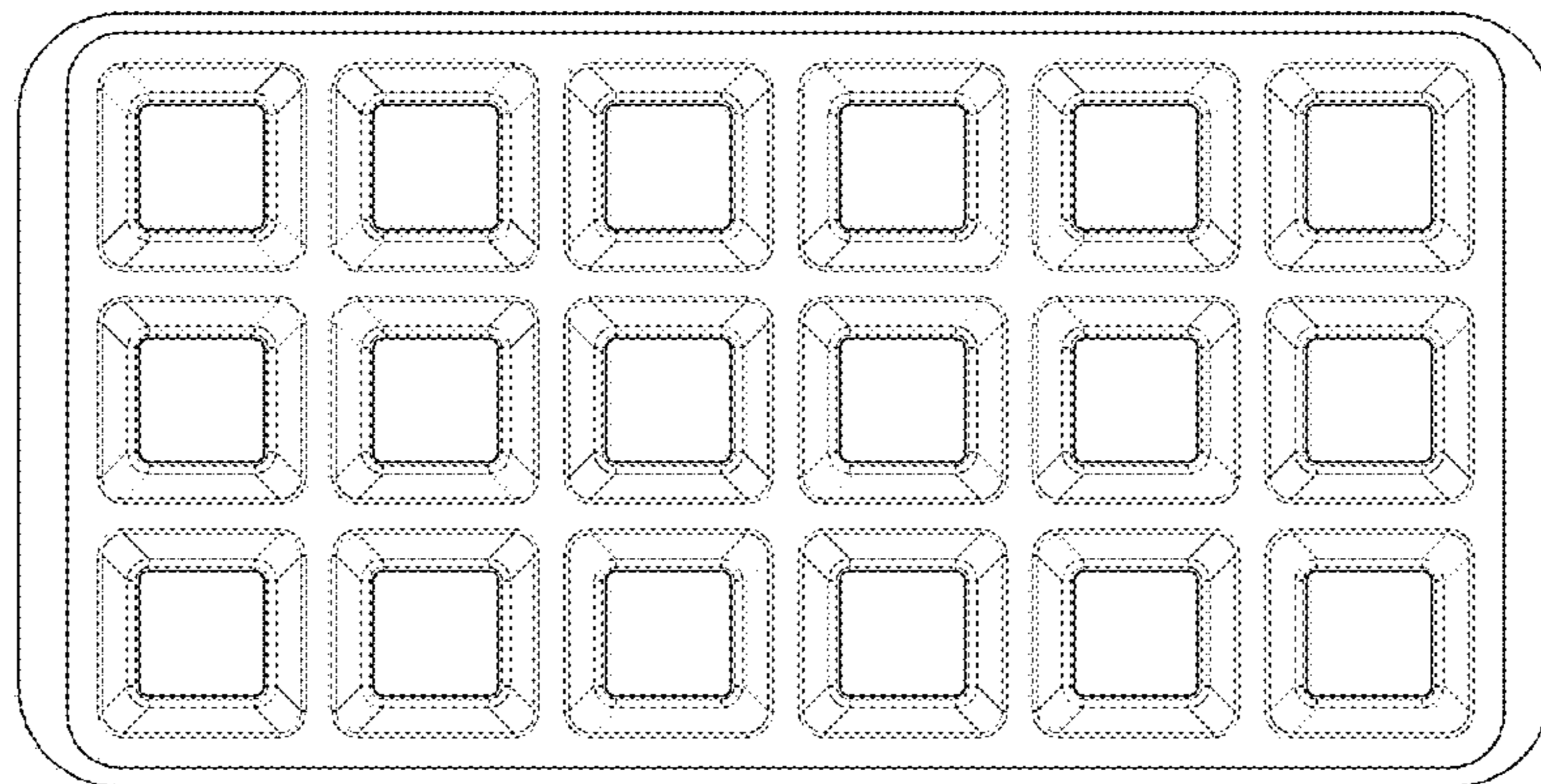

FIG. 18

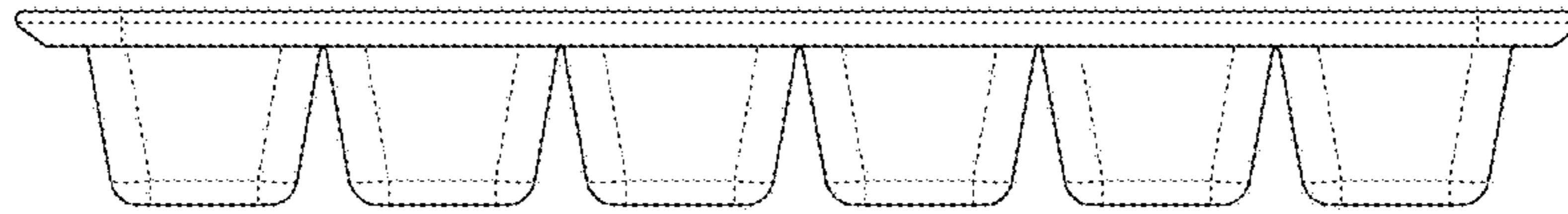

FIG. 19

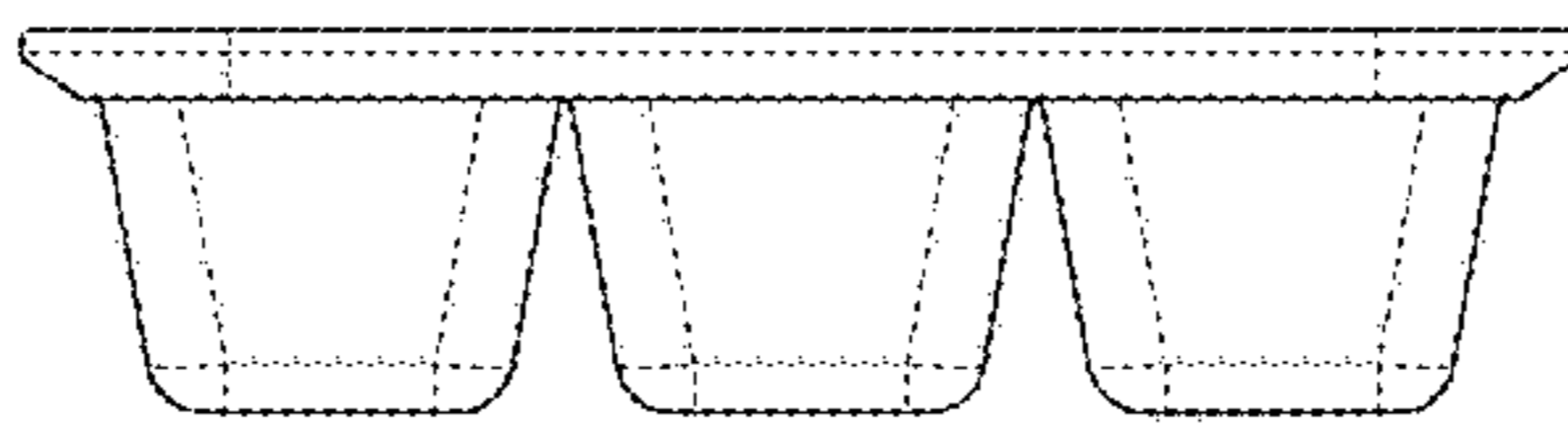

FIG. 20

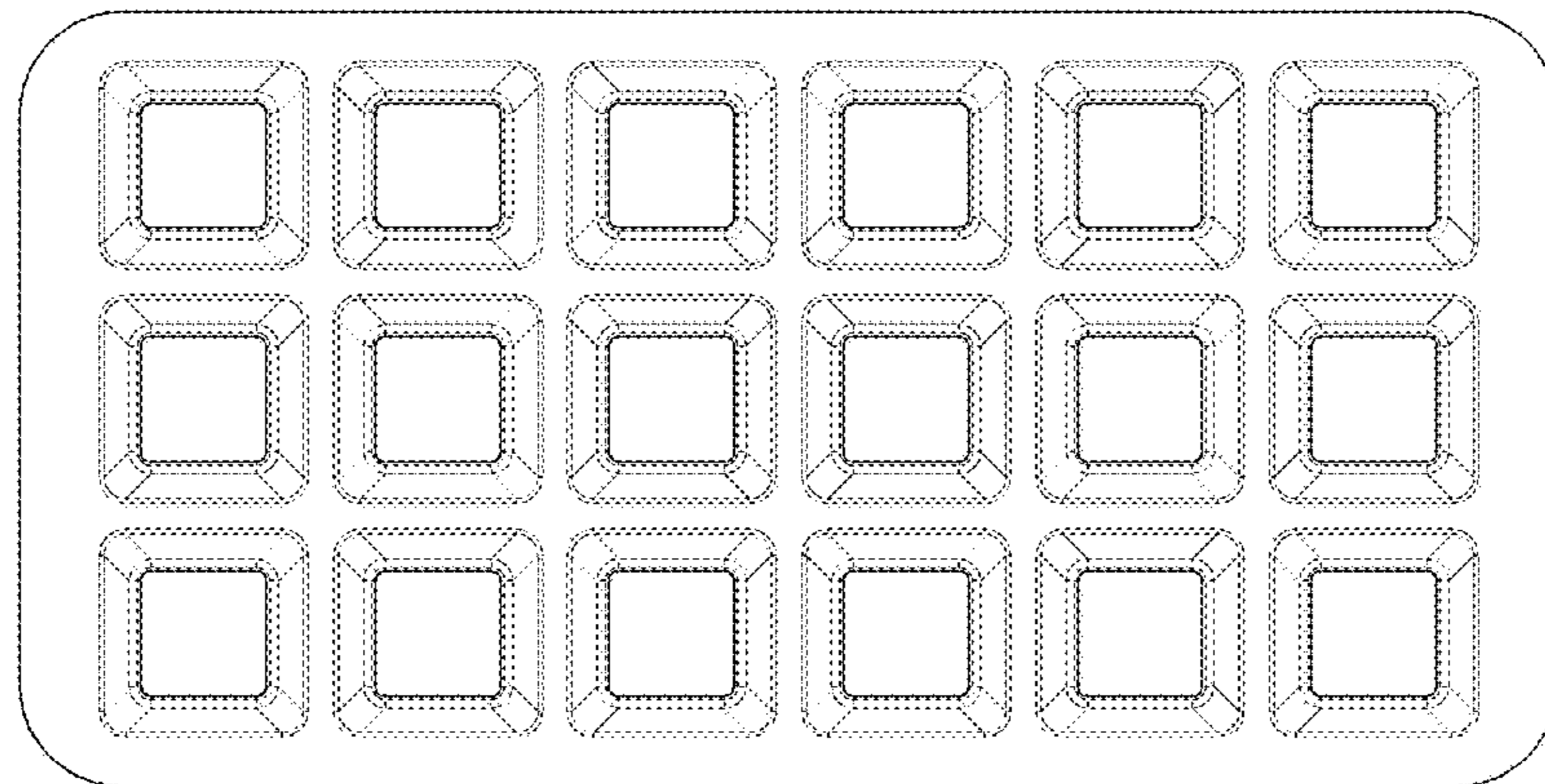

FIG. 21

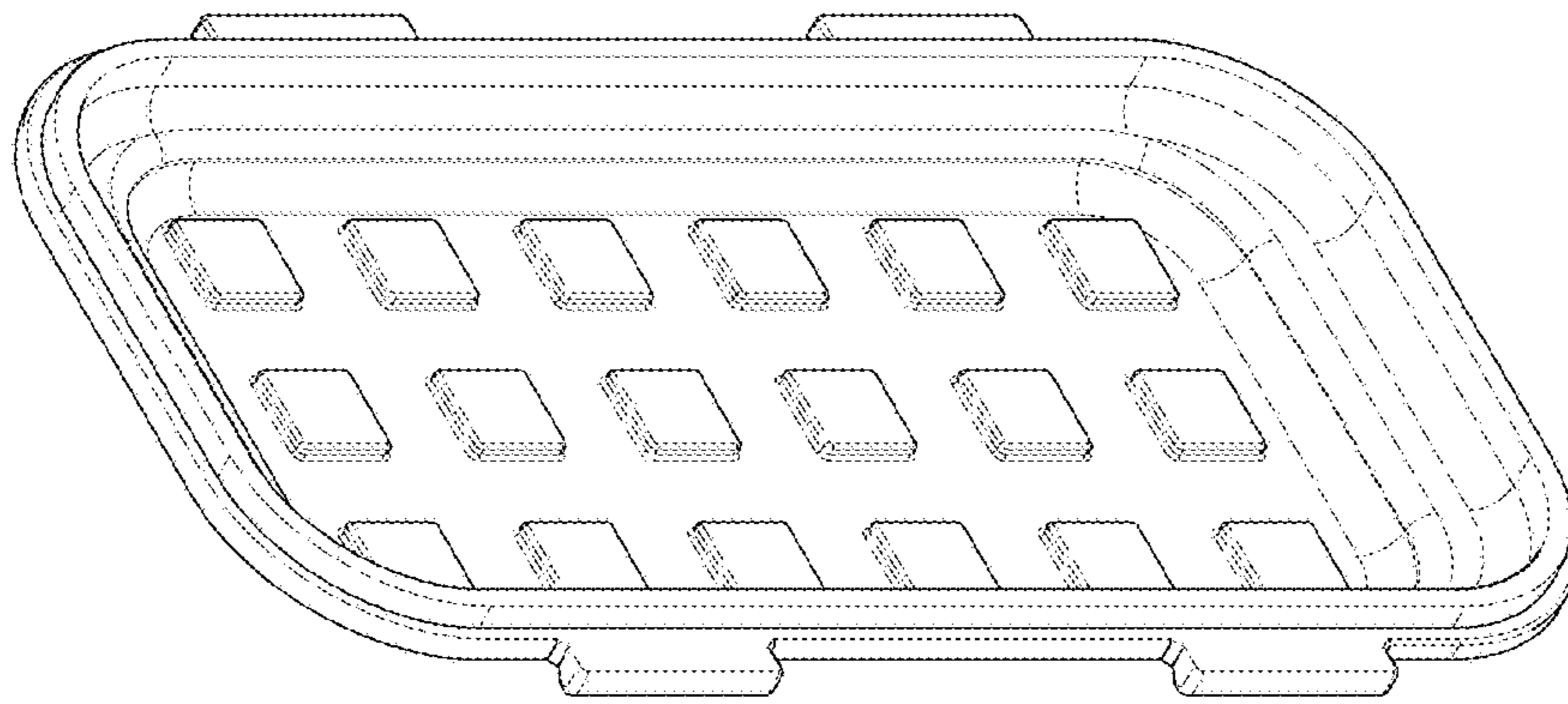

FIG. 22

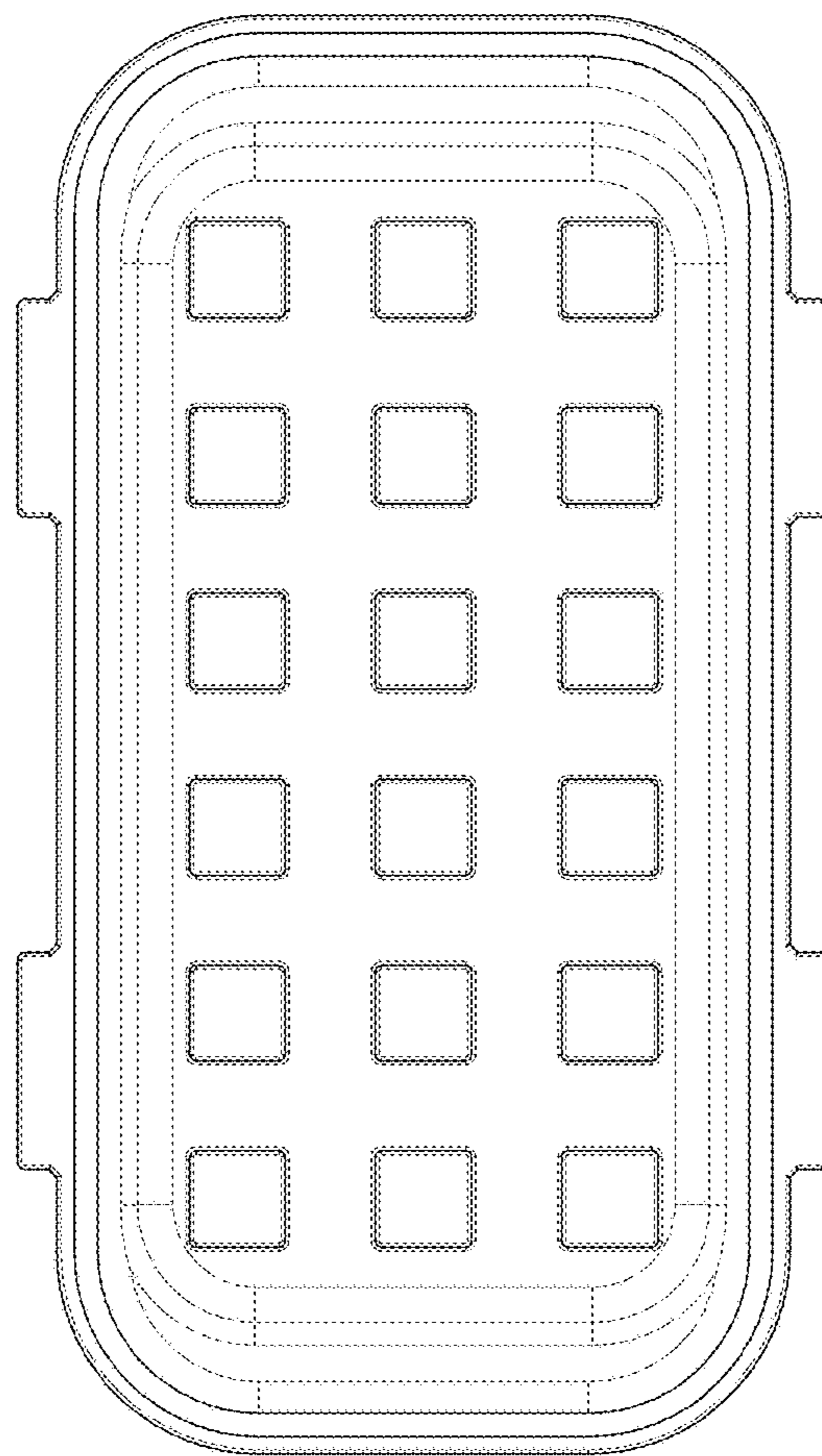

FIG. 23

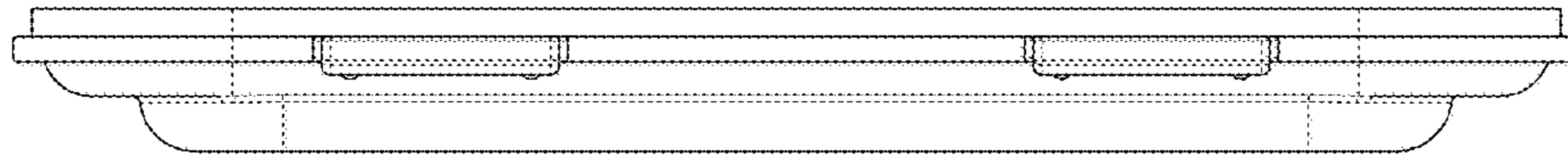

FIG. 24

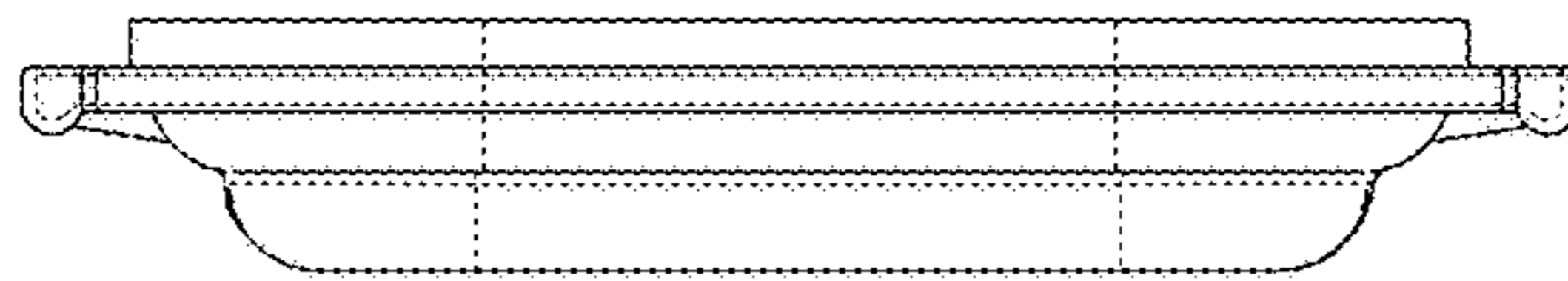

FIG. 25

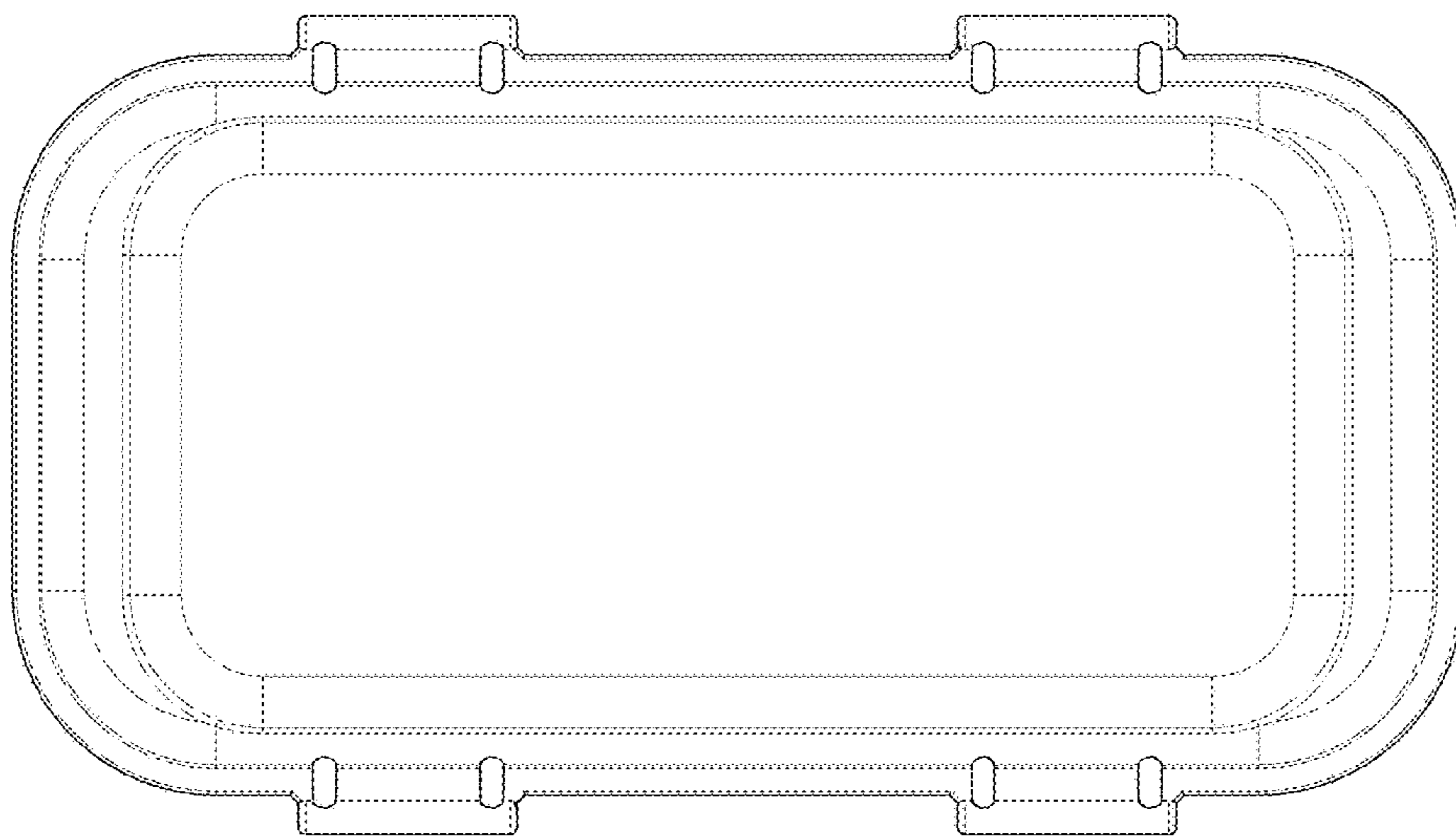

FIG. 26