



US00D854373S

(12) **United States Design Patent** (10) **Patent No.:** **US D854,373 S**
Thompson et al. (45) **Date of Patent:** **** Jul. 23, 2019**

(54) **KNIFE HANDLE**
(71) Applicant: **THE SCOTT FETZER COMPANY,**
Walnut Ridge, AR (US)
(72) Inventors: **Ted Thompson,** Walnut Ridge, AR
(US); **Tim Wiener,** Jonesboro, AR
(US); **Dustin Smith,** Walnut Ridge, AR
(US)

(73) Assignee: **The Scott Fetzer Company,** Walnut
Ridge, AR (US)

(**) Term: **15 Years**

(21) Appl. No.: **29/596,958**

(22) Filed: **Mar. 13, 2017**

(51) **LOC (11) Cl.** **07-99**

(52) **U.S. Cl.**
USPC **D7/401.2**

(58) **Field of Classification Search**
USPC D7/642-654, 662, 664, 666, 669, 672,
D7/673, 676, 681-683, 687, 688,
D7/691-697, 401, 401.1, 401.2, 393;
D8/7, 9, 12, 33, 48, 75, 76, 77, 80, 81,
D8/83, 93, 94, 95, 96, 97, 98, 99, 100,
D8/101, 102, 103, 104, 105, 106, 107,
D8/300, 303, 118; D22/118
CPC A47G 21/02; A47G 21/06; A47G 21/08;
A47G 21/04; B26B 11/00; B26B 29/025;
B26B 1/00; B26B 1/08; B26B 1/10;
B26B 3/00; B26B 3/02; B26B 3/03;
B26B 5/007; B26B 7/00; B26B 7/005;
B26B 11/006; B26B 11/001; B26B
11/003; B26B 11/005; B26B 11/008;
B26B 21/04; B26B 21/4006; B26B 3/04
See application file for complete search history.

(56) **References Cited**

U.S. PATENT DOCUMENTS

D306,675 S * 3/1990 Stiggers D7/649
D403,556 S * 1/1999 Juhlin D7/401.2

D407,267 S * 3/1999 Juhlin D7/401.2
D458,511 S * 6/2002 Rorke D7/395
D503,308 S * 3/2005 Li D7/401.2
D545,140 S * 6/2007 Hasegawa D7/649
D547,135 S * 7/2007 Hasegawa D7/664
D554,428 S * 11/2007 Smith D7/401.2
D637,049 S * 5/2011 Ono D7/649
D639,614 S * 6/2011 Krapfl D7/401.2
D639,615 S * 6/2011 Krapfl D7/401.2

(Continued)

Primary Examiner — Cathron C Brooks
Assistant Examiner — Katrina N Gonzalez
(74) *Attorney, Agent, or Firm* — Tarolli, Sundheim,
Covell & Tummino LLP; John A. Yirga, Esq.

(57) **CLAIM**

The ornamental design for a knife handle, as shown and described.

DESCRIPTION

FIG. 1 is a right front bottom perspective view of a knife handle, showing our new design;
FIG. 2 is a left rear bottom perspective view thereof;
FIG. 3 is a left rear top perspective view thereof;
FIG. 4 is a right front top perspective view thereof;
FIG. 5 is a right side view thereof;
FIG. 6 is a left side view thereof;
FIG. 7 is a top perspective view thereof;
FIG. 8 is a bottom perspective view thereof;
FIG. 9 is a front magnified view thereof;
FIG. 10 is a rear magnified view thereof; and,
FIG. 11 is a right side cross-sectional view, taken along and in the direction of Line 11-11 in FIG. 7.
The broken lines illustrate environmental structure that form no part of the claimed design.
Those portions shown with dashed lines are for illustration purposes only, forming no part of the claimed ornamental design.

1 Claim, 8 Drawing Sheets

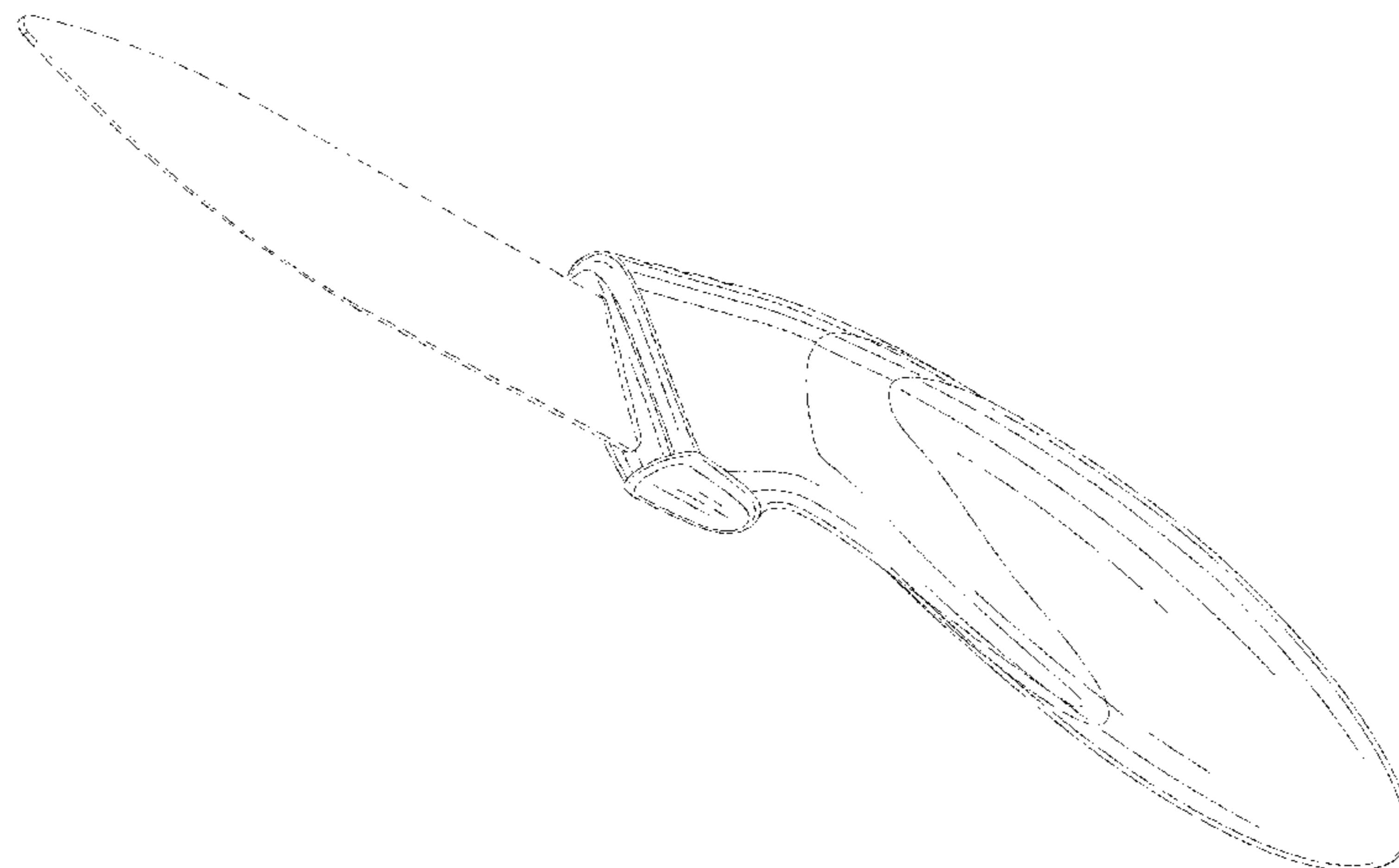

(56)

References Cited

U.S. PATENT DOCUMENTS

D639,616	S	*	6/2011	Krapfl	D7/401.2
D691,419	S	*	10/2013	Bhasin	D7/401.2
D693,186	S	*	11/2013	Hollinger	D7/649
D704,009	S	*	5/2014	Wandrup	D7/642
D747,160	S	*	1/2016	Makela	D7/649
D747,161	S	*	1/2016	Makela	D7/649
D751,862	S	*	3/2016	deBretton Gordon	D7/401.2
D773,888	S	*	12/2016	Liu	D7/401.2
D792,152	S	*	7/2017	Wynne	D7/401.2
D792,153	S	*	7/2017	Wynne	D7/401.2
D792,154	S	*	7/2017	Berger	D7/401.2
D809,339	S	*	2/2018	Lo	D7/401.2

* cited by examiner

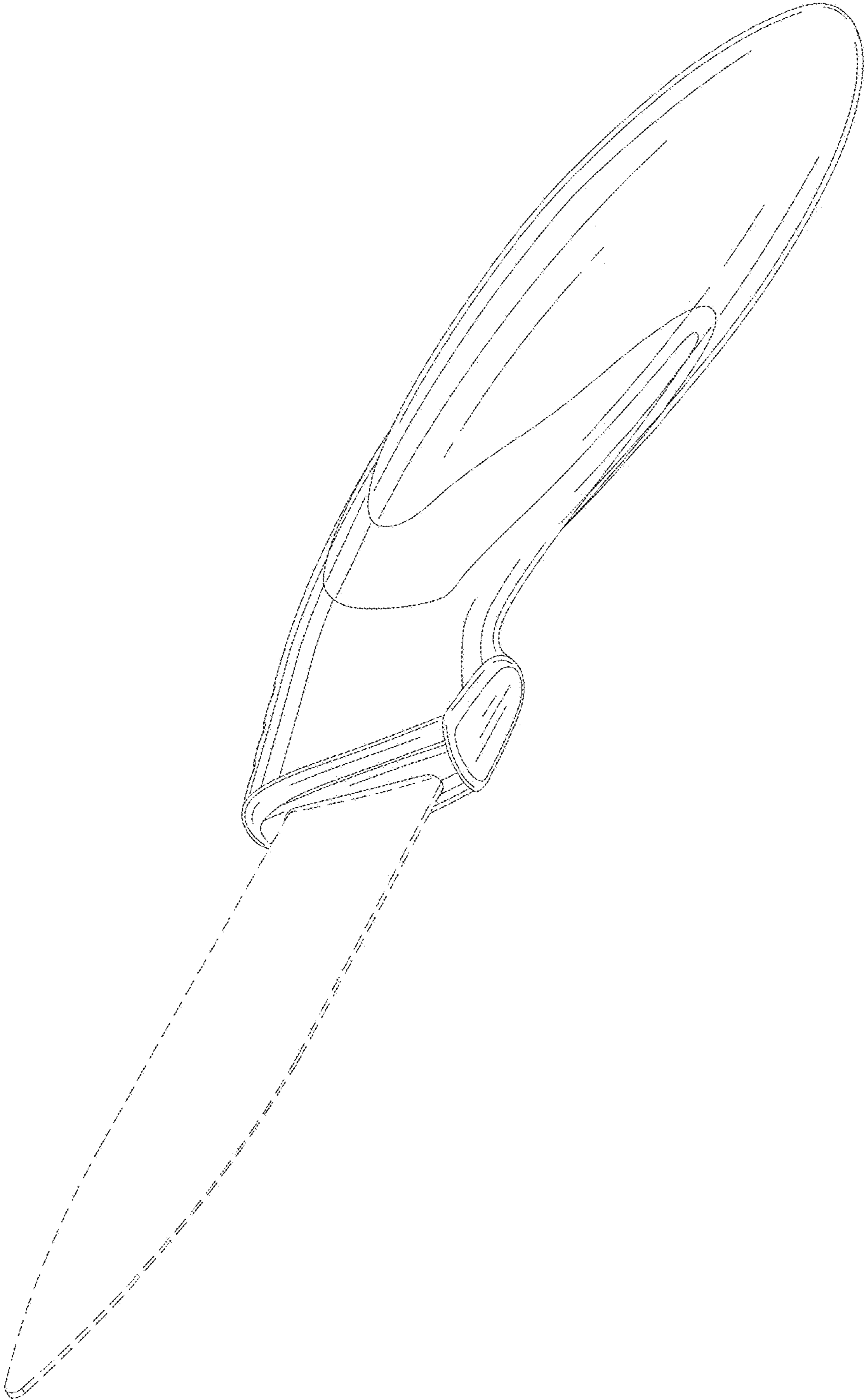

FIG. 1

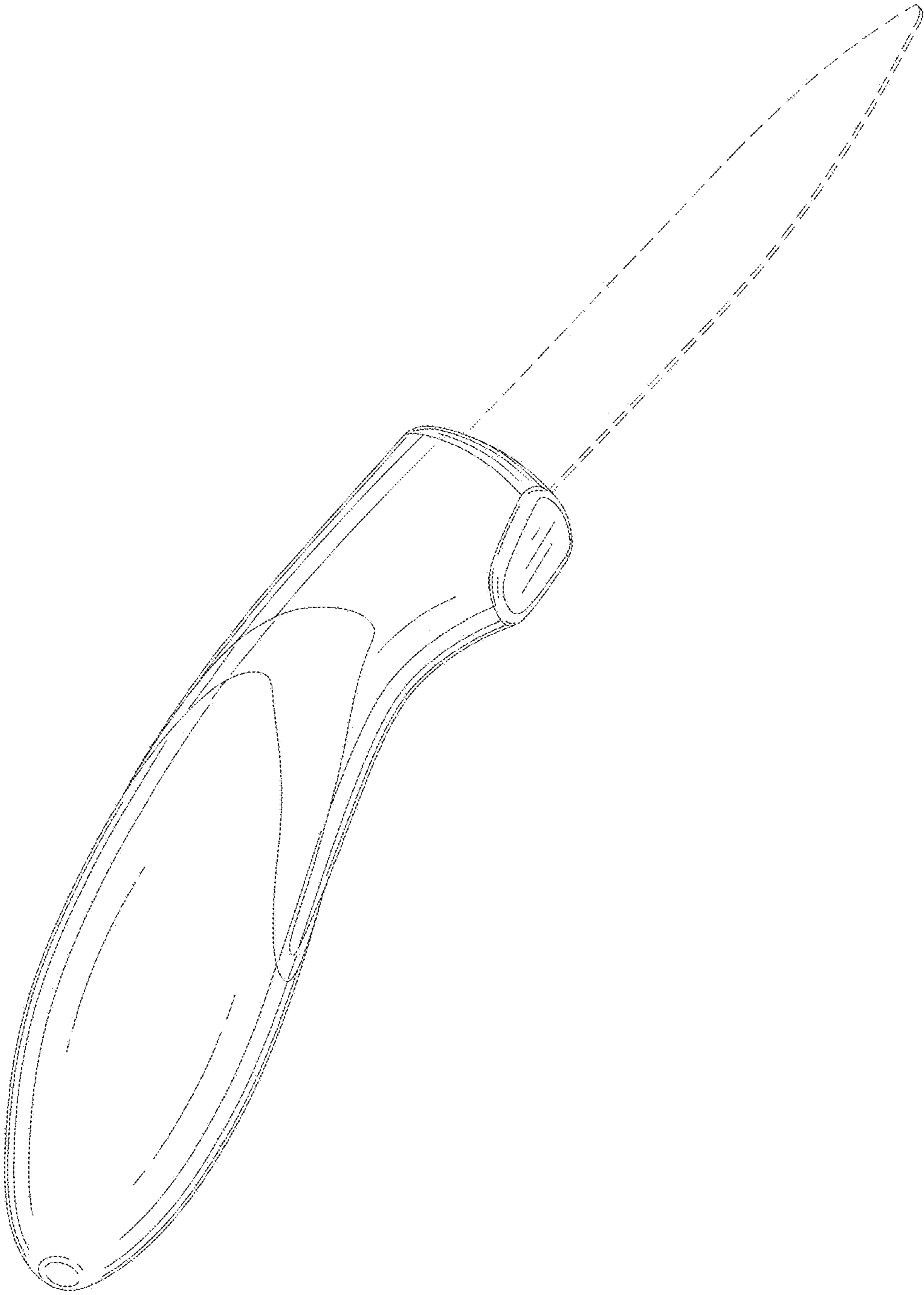

FIG. 2

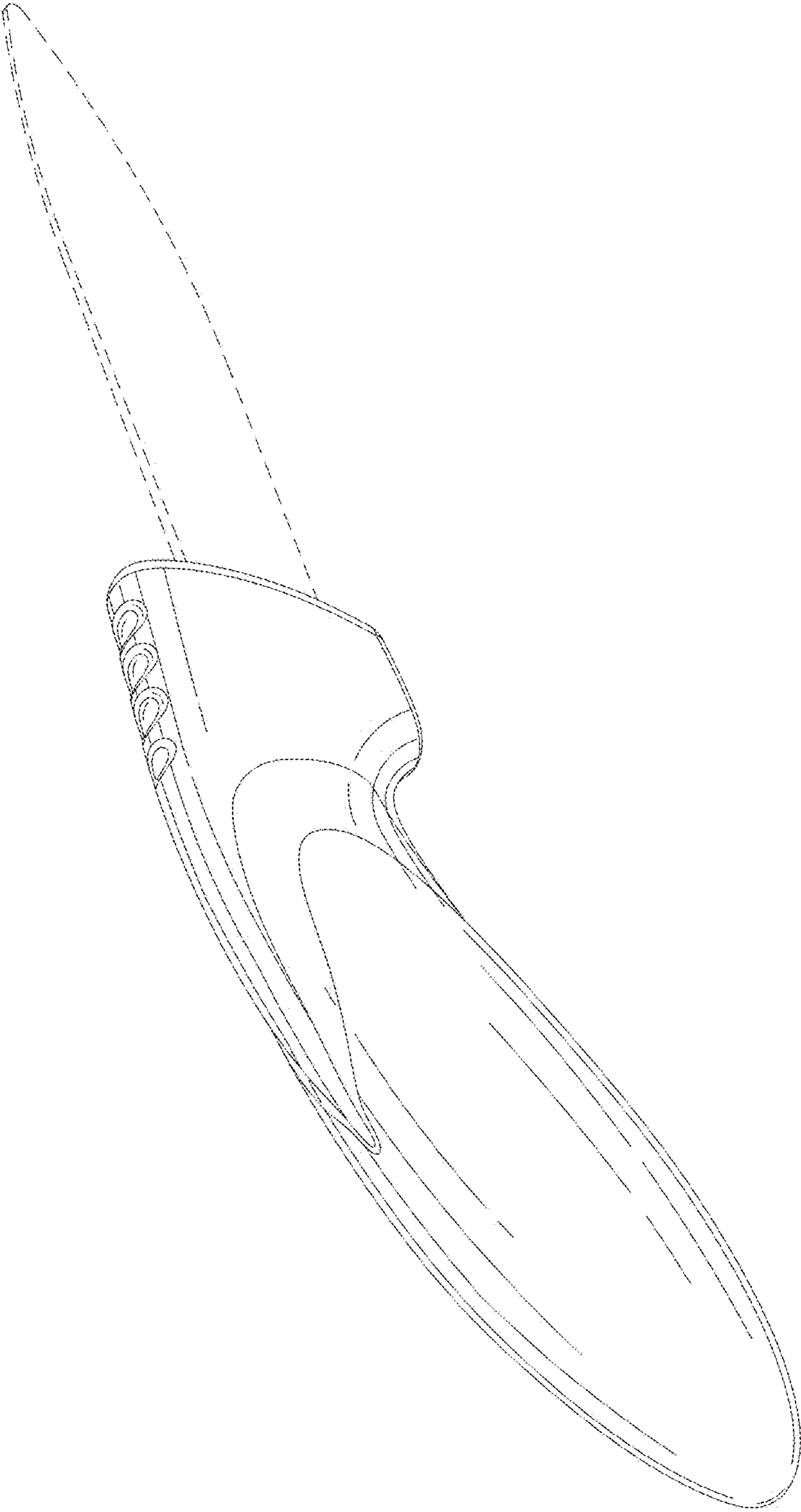

FIG. 3

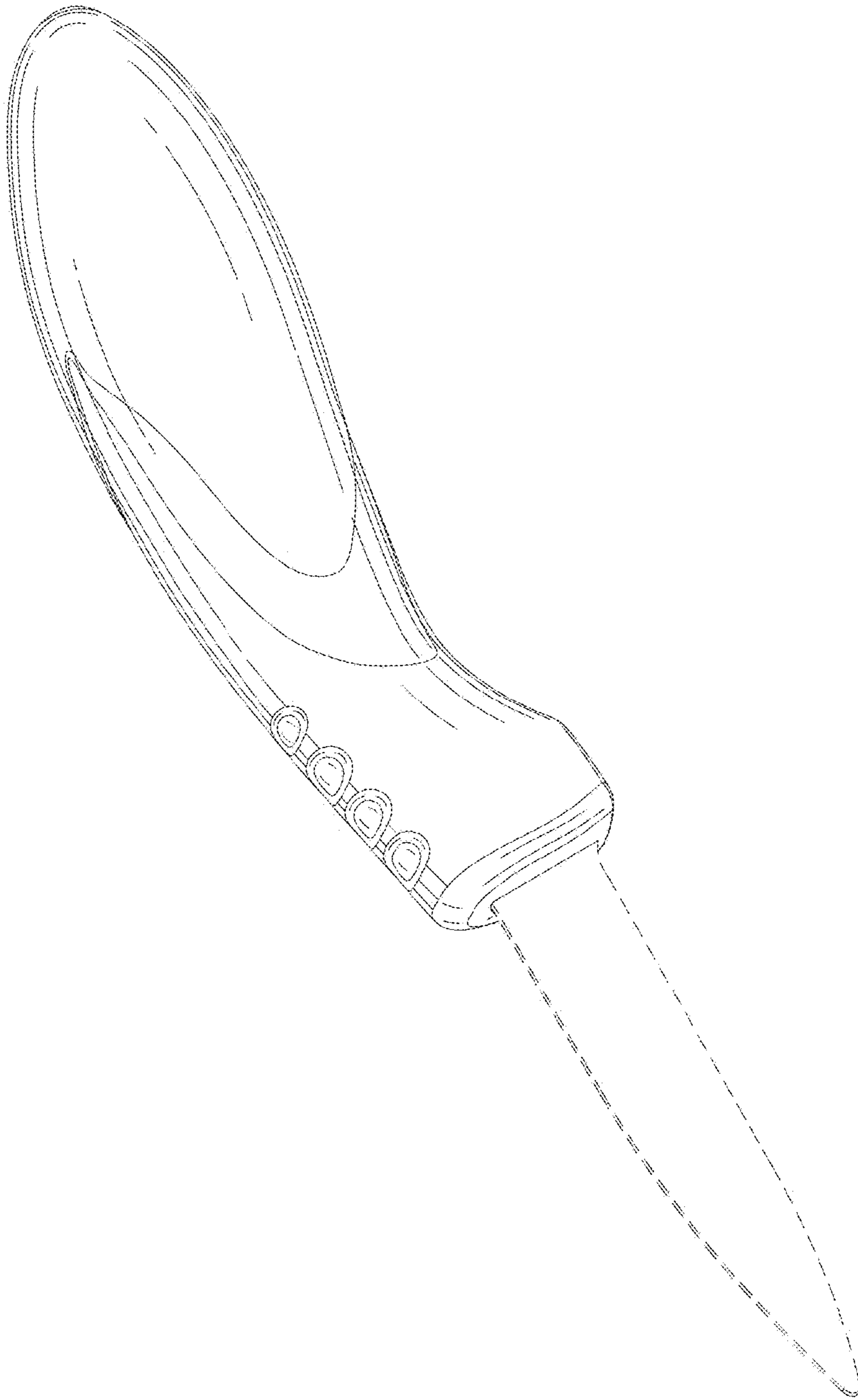

FIG. 4

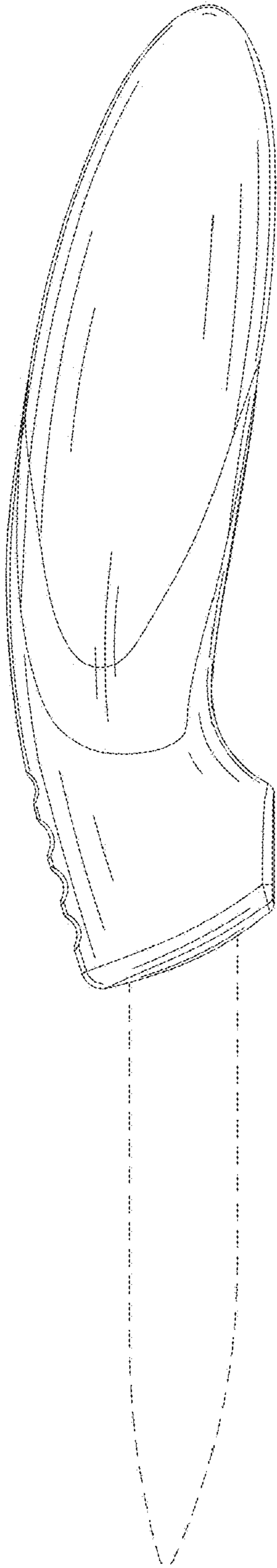

FIG. 5

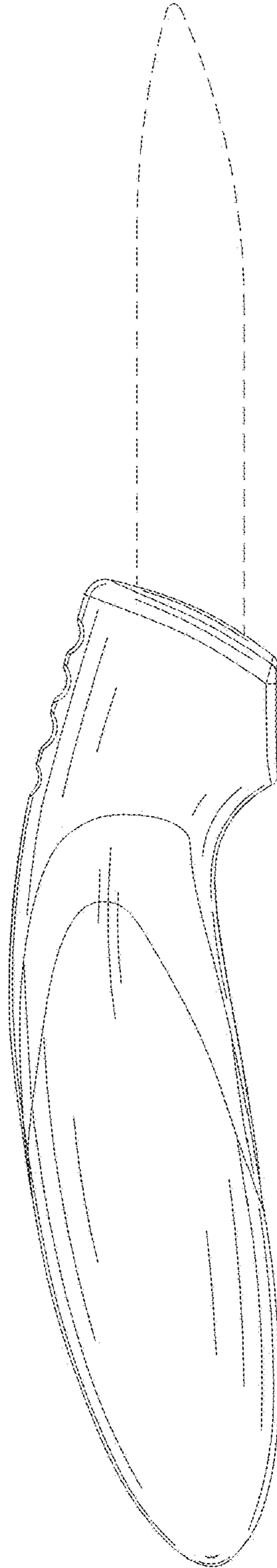

FIG. 6

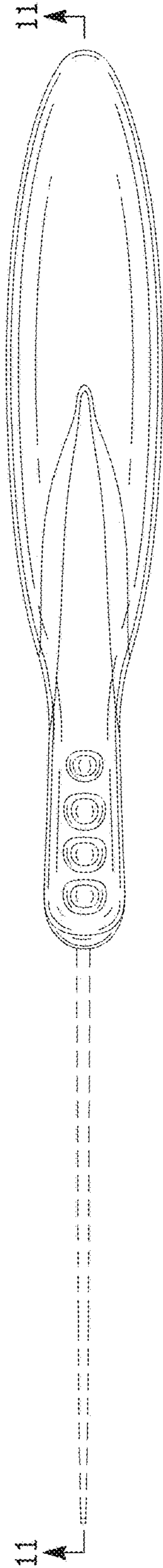

FIG. 7

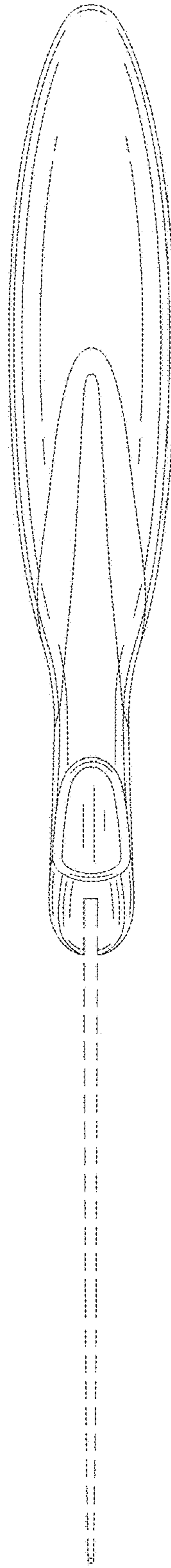

FIG. 8

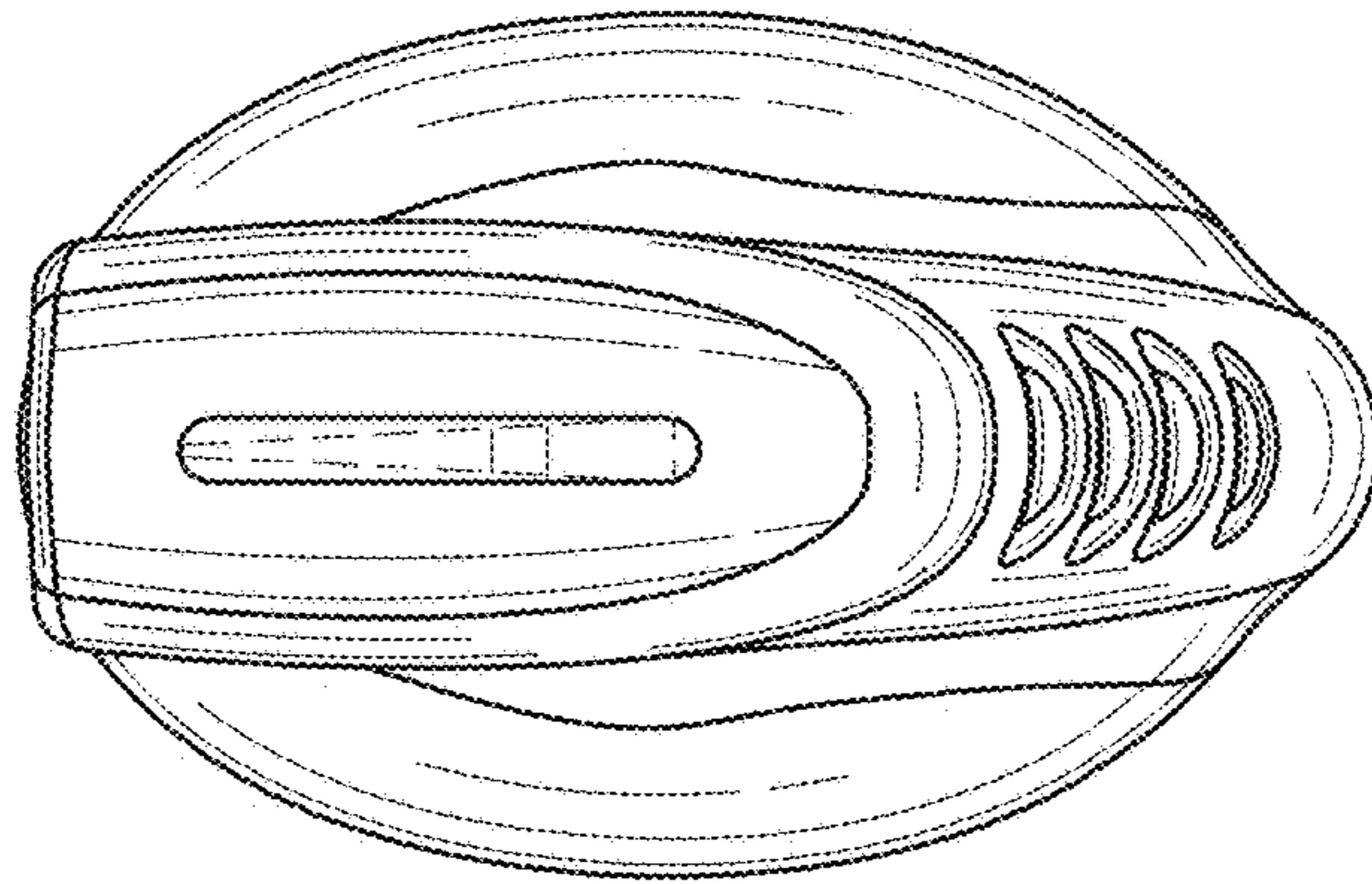

FIG. 9

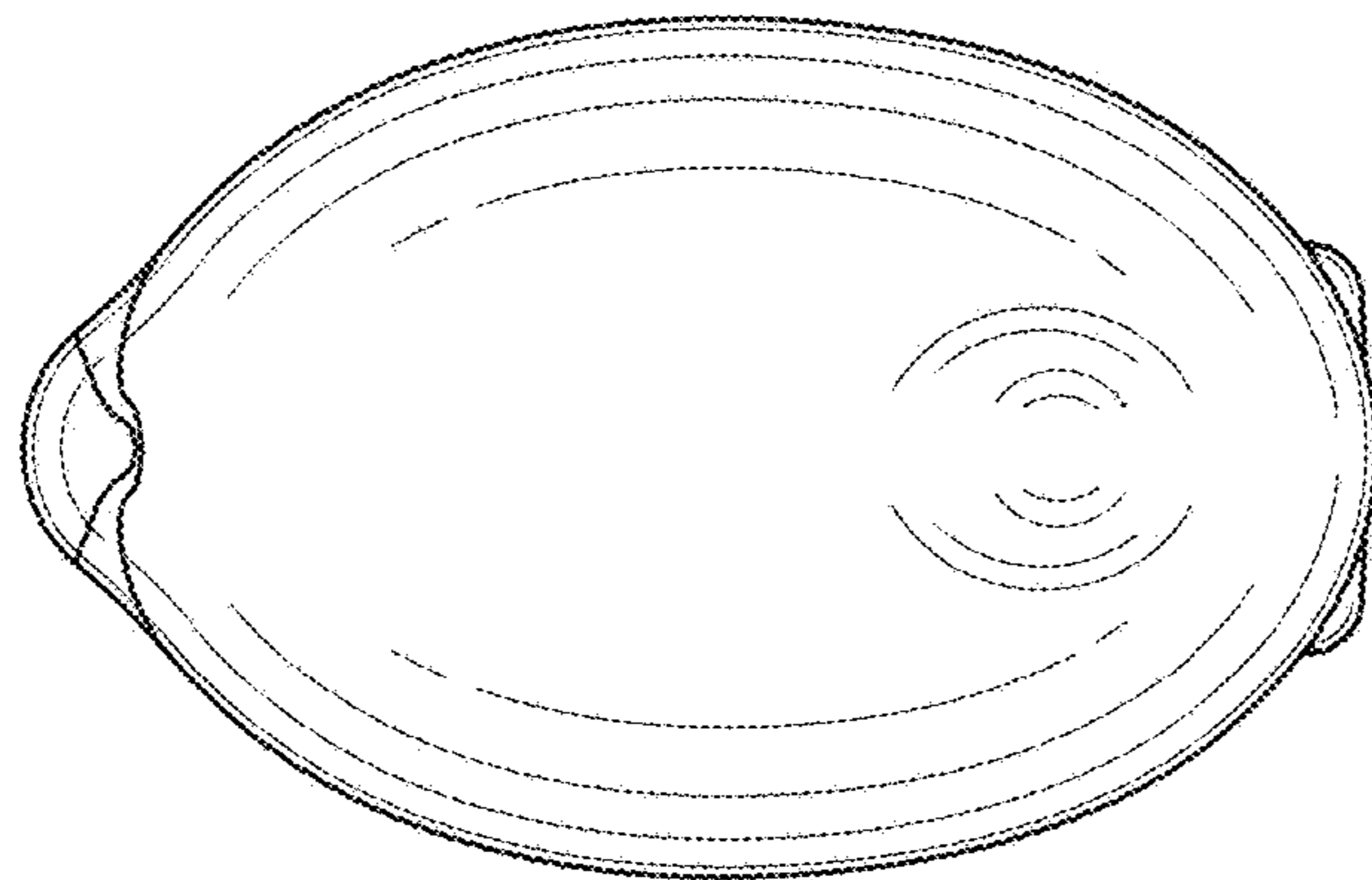

FIG. 10

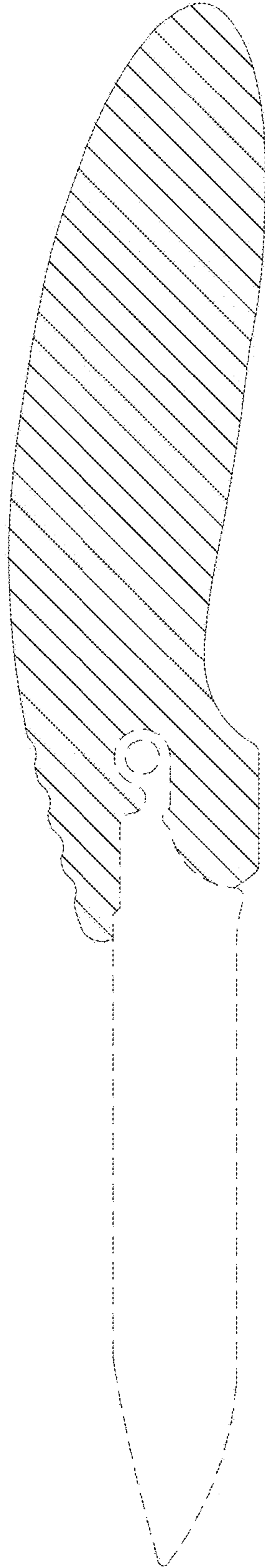

FIG. 11