



US00D854331S

(12) **United States Design Patent** (10) **Patent No.:** **US D854,331 S**
Hielscher et al. (45) **Date of Patent:** **** *Jul. 23, 2019**

(54) **TOOTHBRUSH HEAD**

(71) Applicant: **The Gillette Company LLC**, Boston, MA (US)

(72) Inventors: **Christine Hielscher**, Frankfurt (DE); **Sarah Mote**, Frankfurt (DE); **Dominik Langhammer**, Frankfurt (DE); **Tilmann Winkler**, Kronberg (DE); **Aycan Senturk-Andersson**, Frankfurt (DE); **Benedikt Heil**, Friedberg (DE)

(73) Assignee: **THE GILLETTE COMPANY LLC**, Boston, MA (US)

(*) Notice: This patent is subject to a terminal disclaimer.

(**) Term: **15 Years**

(21) Appl. No.: **29/618,547**

(22) Filed: **Sep. 21, 2017**

(30) **Foreign Application Priority Data**

Mar. 22, 2017 (WO) 2823801

(51) **LOC (11) Cl.** **04-02**

(52) **U.S. Cl.**
USPC **D4/104**

(58) **Field of Classification Search**
USPC D4/104, 105, 106, 107, 108, 109, 110, D4/111, 112, 113, 114, 115, 116, 117, D4/118, 121, 122, 123, 134, 135, 126, D4/127, 128, 129, 101

CPC A46B 9/02; A46B 9/04; A46B 15/0081; A46B 2200/1066; A46B 2200/1073

See application file for complete search history.

(56) **References Cited**

U.S. PATENT DOCUMENTS

2,242,743 A * 5/1941 Brown A46B 9/04 15/167.1

6,397,425 B1 * 6/2002 Szczech A46B 5/0062 15/143.1

D463,668 S 10/2002 Yoshimoto et al.
7,174,596 B2 2/2007 Fischer et al.
D549,459 S 8/2007 Crossman
D559,546 S 1/2008 Wong
D582,682 S 12/2008 Kling et al.
D609,013 S * 2/2010 Kling D4/108
D612,613 S 3/2010 Pusch et al.
D621,621 S * 8/2010 Winkler D4/104

(Continued)

FOREIGN PATENT DOCUMENTS

CN 300856984 12/2008
CN 301961508 * 6/2012

(Continued)

OTHER PUBLICATIONS

Design U.S. Appl. No. 29/618,550 to Hielscher et al. filed Sep. 21, 2017. (Year: 2017).*

(Continued)

Primary Examiner — Karen E Eldridge Powers

(74) *Attorney, Agent, or Firm* — James E. Oehlenschlager; Jason J Camp

(57) **CLAIM**

The ornamental design for a toothbrush head, as shown and described.

DESCRIPTION

FIG. 1 is a perspective view of a toothbrush head; FIG. 2 is a front elevation view thereof; FIG. 3 is a right side elevation view thereof; FIG. 4 is a rear elevation view thereof; FIG. 5 is a left side elevation view thereof; FIG. 6 is a top plan view thereof; and, FIG. 7 is a bottom plan view thereof.

1 Claim, 1 Drawing Sheet

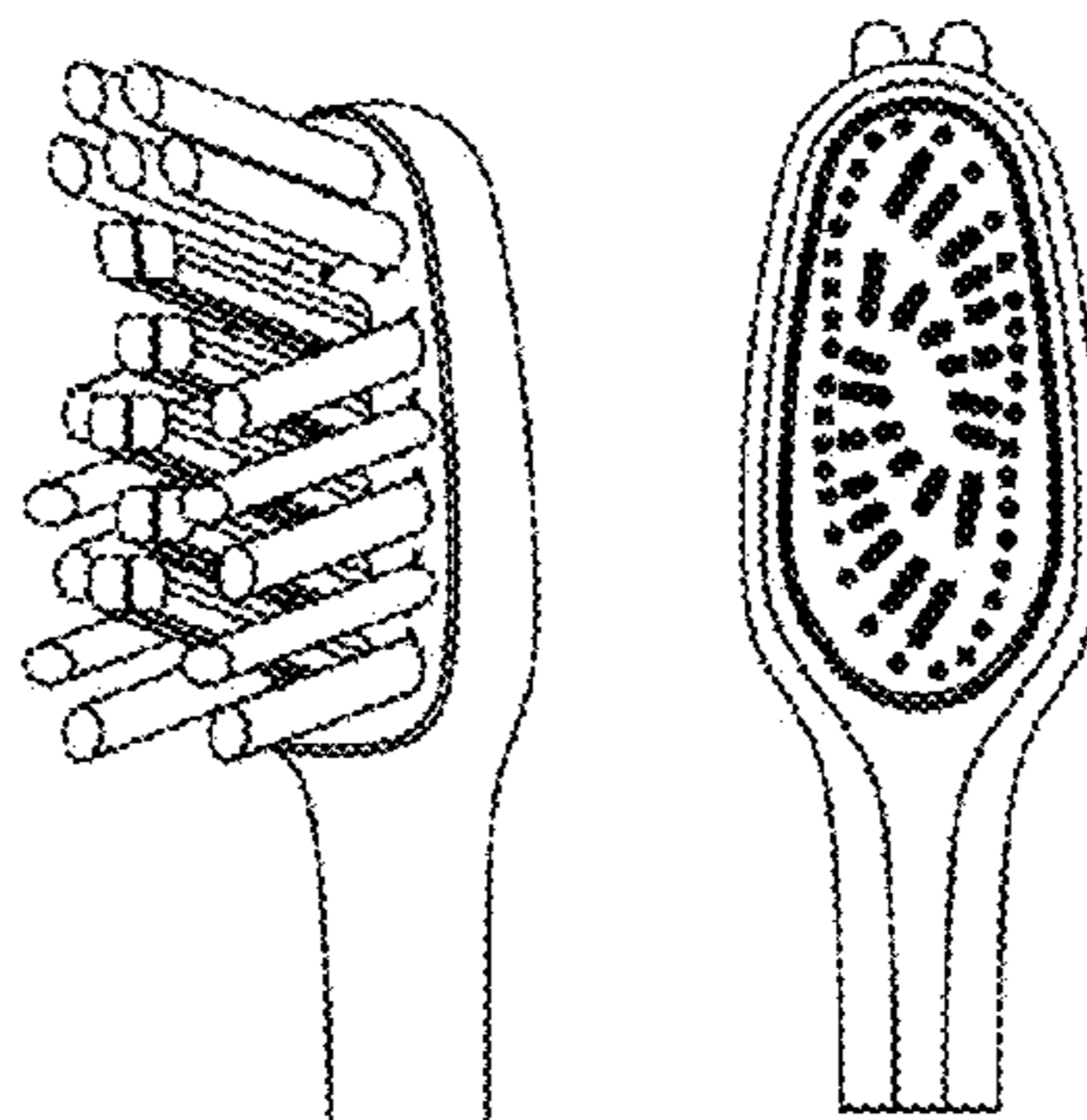

(56)

References Cited

FOREIGN PATENT DOCUMENTS

U.S. PATENT DOCUMENTS

D637,401 S * 5/2011 Pusch D4/104
 8,006,342 B2 8/2011 Nanda
 D646,063 S 10/2011 Ballmaier et al.
 8,156,602 B2 4/2012 Jimenez et al.
 8,239,995 B2 * 8/2012 Chenvainu A46B 7/06
 15/167.1
 D676,663 S 2/2013 Ptok et al.
 8,464,388 B2 6/2013 Chen
 D696,518 S * 12/2013 Ballmaier D4/104
 D698,156 S 1/2014 Kling
 8,840,192 B2 9/2014 Lotscher et al.
 D723,282 S 3/2015 Fretwell et al.
 D724,324 S * 3/2015 Ballmaier D4/108
 D730,059 S * 5/2015 Storkel D4/108
 D751,295 S 3/2016 Lee et al.
 D751,296 S 3/2016 Xi et al.
 D753,401 S 4/2016 Schmid et al.
 D759,977 S 6/2016 Lozoya
 D762,391 S 8/2016 Ballmaier et al.
 D764,804 S 8/2016 Lee et al.
 D765,983 S 9/2016 Jimenez et al.
 D765,986 S 9/2016 Jimenez et al.
 D778,062 S * 2/2017 Schmid D4/108
 9,566,225 B2 2/2017 Sagel et al.
 D784,022 S 4/2017 Bertrand et al.
 9,675,168 B2 6/2017 Jungnickel et al.
 D798,062 S 9/2017 Bauernfeind et al.
 D819,339 S 6/2018 Schmid et al.
 10,021,962 B2 * 7/2018 Tschol A46B 9/04
 D833,756 S 11/2018 Hielscher et al.
 D833,757 S 11/2018 Hielscher et al.
 D834,324 S 11/2018 Hielscher et al.
 2005/0053898 A1 3/2005 Ghosh et al.
 2006/0048323 A1 * 3/2006 Rueb A46B 9/04
 15/167.1
 2007/0131241 A1 6/2007 Nanda
 2010/0043162 A1 * 2/2010 Zimmermann A46B 15/0055
 15/111
 2010/0115724 A1 * 5/2010 Huang A46B 9/025
 15/167.1
 2011/0277256 A1 11/2011 Jo

CN 302033831 8/2012
 CN 303687291 6/2016
 CN 304648497 5/2018
 CN 304648504 5/2018
 JP D1497915 5/2014
 JP 1516192 1/2015
 KR 3009571370003 5/2018
 KR 3009571370004 5/2018
 TR 083124-0004 * 11/2016
 TR 083124-0005 * 11/2016
 WO DM077470 7/2014
 WO WO-DM/077470 * 7/2014
 WO D086807-003 11/2015
 WO D086807-025 11/2015
 WO D086807-033 11/2015
 WO D086807-036 11/2015
 WO DM086685 11/2015
 WO DM086807 11/2015
 WO D086900-001 12/2015
 WO D086900-002 12/2015
 WO D086900-003 12/2015
 WO D086900-004 12/2015
 WO D086900-005 12/2015
 WO D086900-006 12/2015
 WO D086900-007 12/2015
 WO D086900-008 12/2015
 WO D086900-009 12/2015
 WO D086900-010 12/2015
 WO D086900-011 12/2015
 WO DM084383 3/2016
 WO WO-DM/084383 * 3/2016
 WO DM083124 11/2016
 WO DM085680 8/2017
 WO WO-DM/085680 * 8/2017

OTHER PUBLICATIONS

U.S. Appl. No. 29/618,551, filed Sep. 21, 2017, Hielscher et al.
 U.S. Appl. No. 29/618,554, filed Sep. 21, 2017, Hielscher et al.
 U.S. Appl. No. 29/618,555, filed Sep. 21, 2017, Hielscher et al.
 U.S. Appl. No. 29/618,556, filed Sep. 21, 2017, Hielscher et al.
 U.S. Appl. No. 29/618,557, filed Sep. 21, 2017, Hielscher et al.
 U.S. Appl. No. 29/618,559, filed Sep. 21, 2017, Hielscher et al.
 U.S. Appl. No. 29/618,563, filed Sep. 21, 2017, Hielscher et al.
 U.S. Appl. No. 29/618,565, filed Sep. 21, 2017, Hielscher et al.

* cited by examiner

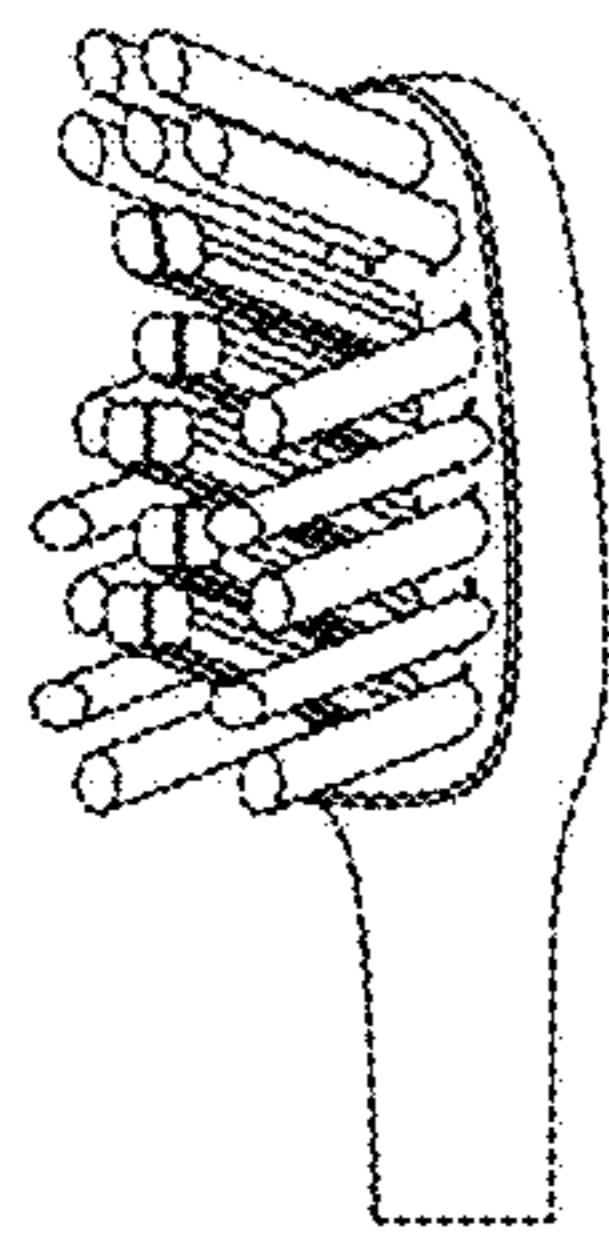

FIG. 1

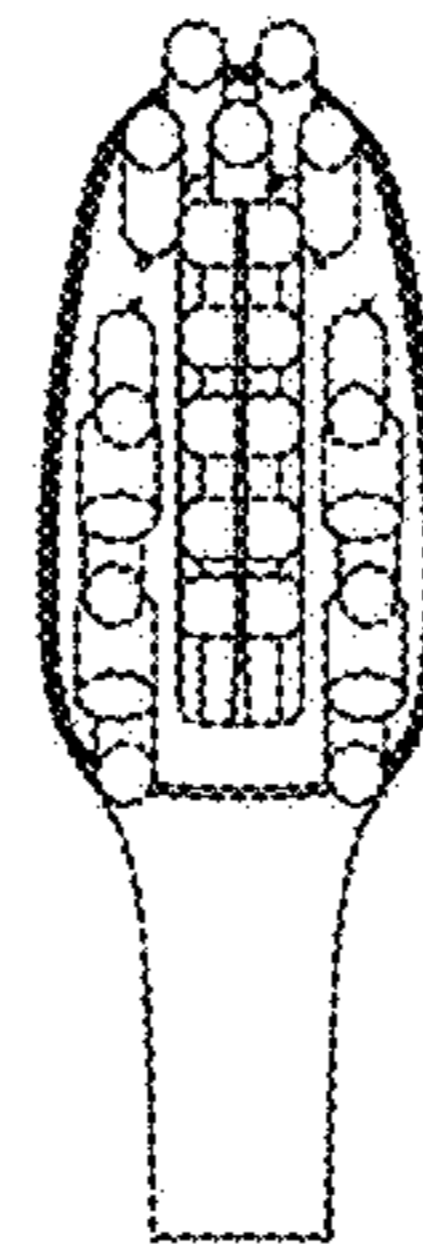

FIG. 2

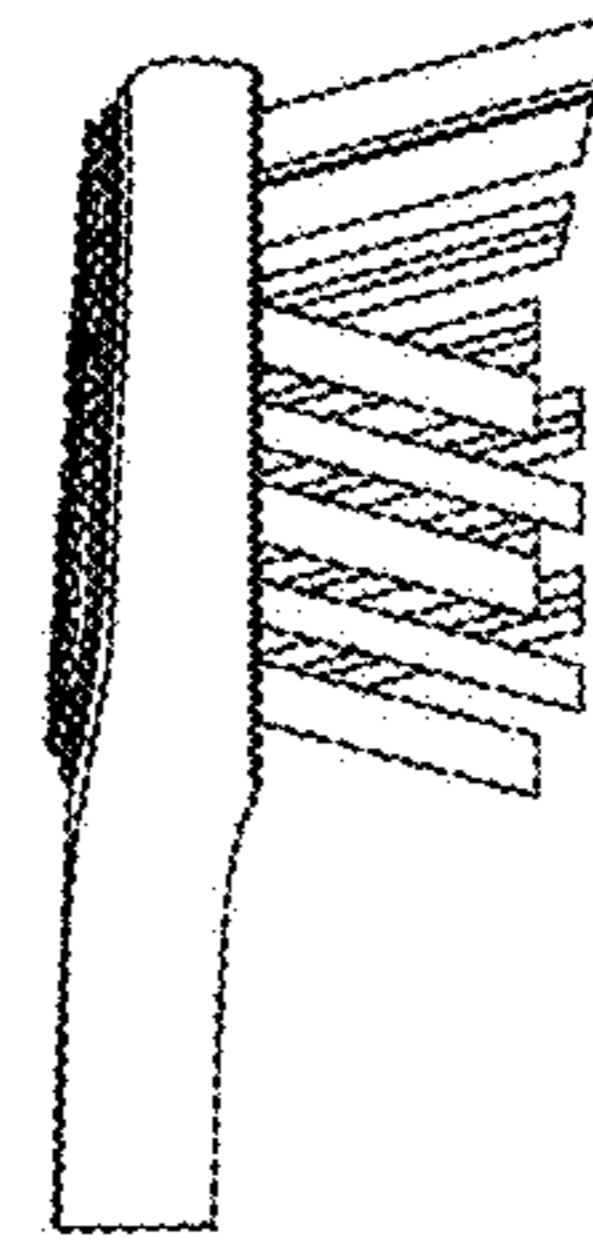

FIG. 3



FIG. 4

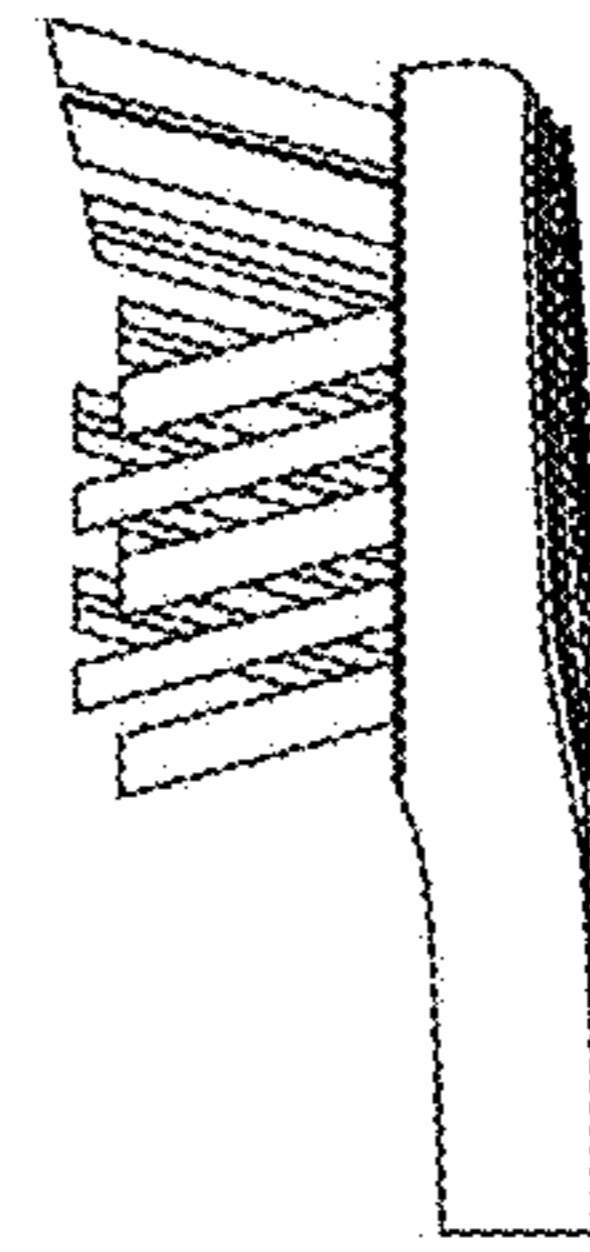

FIG. 5

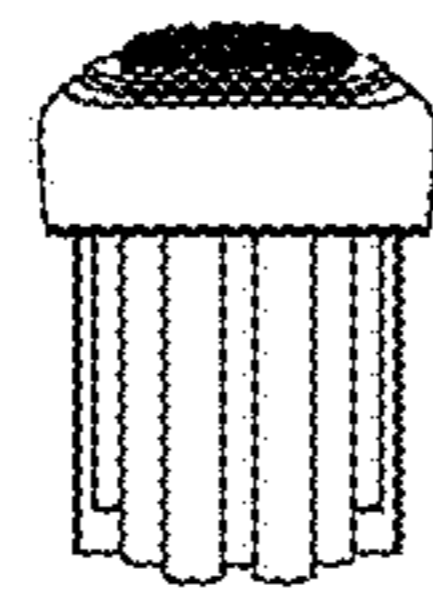

FIG. 6

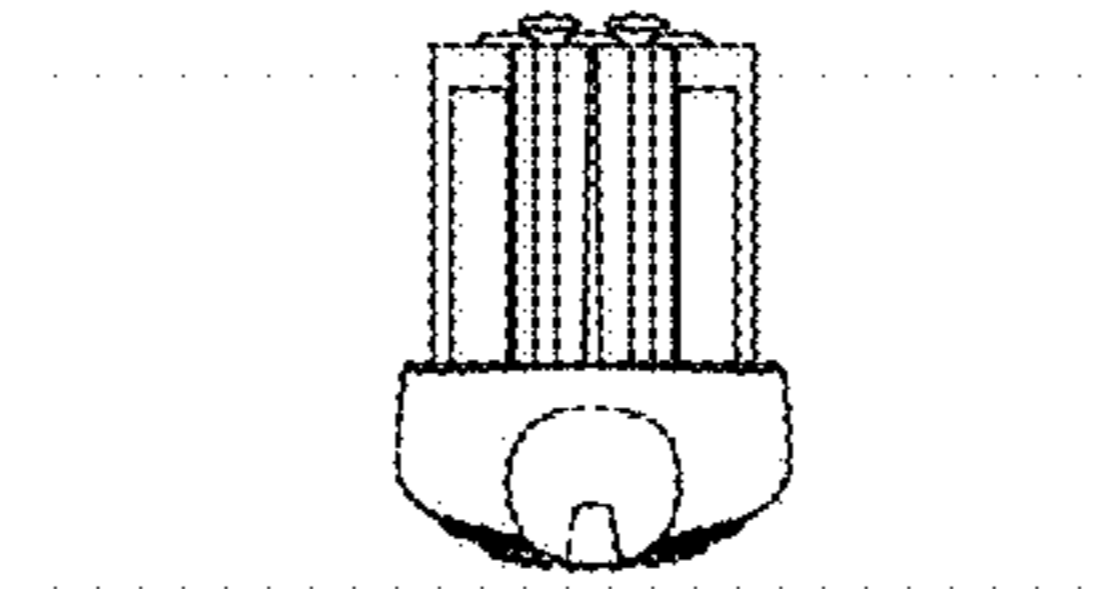

FIG. 7