



US00D854292S

(12) **United States Design Patent**  
**Mokos et al.**

(10) **Patent No.:** **US D854,292 S**

(45) **Date of Patent:** **\*\* Jul. 23, 2019**

(54) **SHOE SOUL**

(71) Applicant: **Cole Haan LLC**, New York City, NY (US)

(72) Inventors: **Jeffrey Mokos**, New York City, NY (US); **Brett Brown**, New York City, NY (US); **Mathew Chapdelaine**, Manchester, NH (US); **Scott Patt**, New York City, NY (US)

(73) Assignee: **COLE HAAN LLC**, New York, NY (US)

(\*\*) Term: **15 Years**

(21) Appl. No.: **29/632,345**

(22) Filed: **Jan. 7, 2018**

(51) **LOC (11) Cl.** ..... **02-04**

(52) **U.S. Cl.**  
USPC ..... **D2/953**; 947/951; 947/957; 947/960

(58) **Field of Classification Search**  
USPC ..... D2/902, 906, 908, 916, 918, 925, D2/946-962, 977; 36/3 B, 22 R, 24.5, 36/25 R, 28, 32 R, 34 R, 59 C, 67 A, 103  
CPC ..... A43B 13/00; A43B 13/02; A43B 13/023; A43B 13/026; A43B 13/04; A43B 13/08; A43B 13/10; A43B 13/12; A43B 13/14; A43B 13/141; A43B 13/143; A43B 13/16; A43B 13/18; A43B 13/181; A43B 13/187; A43B 13/189; A43B 13/20; A43B 13/22; A43B 13/223; A43B 13/24; A43B 13/28; A43B 13/30; A43B 13/32; A43B 13/34; A43B 13/36

See application file for complete search history.

(56) **References Cited**

**U.S. PATENT DOCUMENTS**

D113,620 S \* 3/1939 Cairns ..... D2/955  
D159,466 S \* 8/1950 Baltzer ..... D2/957

D195,542 S \* 7/1963 Webster ..... D2/957  
D203,577 S \* 2/1966 Weisburg ..... 36/59 C  
D326,179 S \* 5/1992 Walker ..... D2/954  
5,237,760 A \* 8/1993 Altman ..... A43B 1/0036  
36/103  
D513,838 S \* 1/2006 Birkenstock ..... D2/916  
D547,035 S \* 7/2007 Belley ..... D2/951  
7,287,342 B2 \* 10/2007 Keen ..... A43B 3/22  
36/50.1  
D554,837 S \* 11/2007 Andersen ..... D2/951  
D561,985 S \* 2/2008 Andersen ..... D2/957  
D589,692 S \* 4/2009 McClaskie ..... D2/951  
7,631,440 B2 \* 12/2009 Keen ..... A43B 1/14  
36/50.1  
7,658,018 B2 \* 2/2010 Lin ..... A43B 17/08  
36/3 B

(Continued)

*Primary Examiner* — T Chase Nelson

(74) *Attorney, Agent, or Firm* — Thompson Coburn LLP

(57) **CLAIM**

The ornamental design for a shoe sole, as shown and described.

**DESCRIPTION**

FIG. 1 is a first perspective view of the shoe sole showing our new design;  
FIG. 2 is a second perspective view thereof;  
FIG. 3 is a front view thereof;  
FIG. 4 is a rear view thereof;  
FIG. 5 is a right side view thereof;  
FIG. 6 is a left side view thereof;  
FIG. 7 is a top view thereof;  
FIG. 8 is a bottom view thereof; and,  
FIG. 9 is a third perspective view thereof.  
The broken lines immediately adjacent the shaded areas represent the bounds of the claimed design while all other broken lines are directed to environment and are for illustrative purposes only; the broken lines form no part of the claimed design.

**1 Claim, 9 Drawing Sheets**

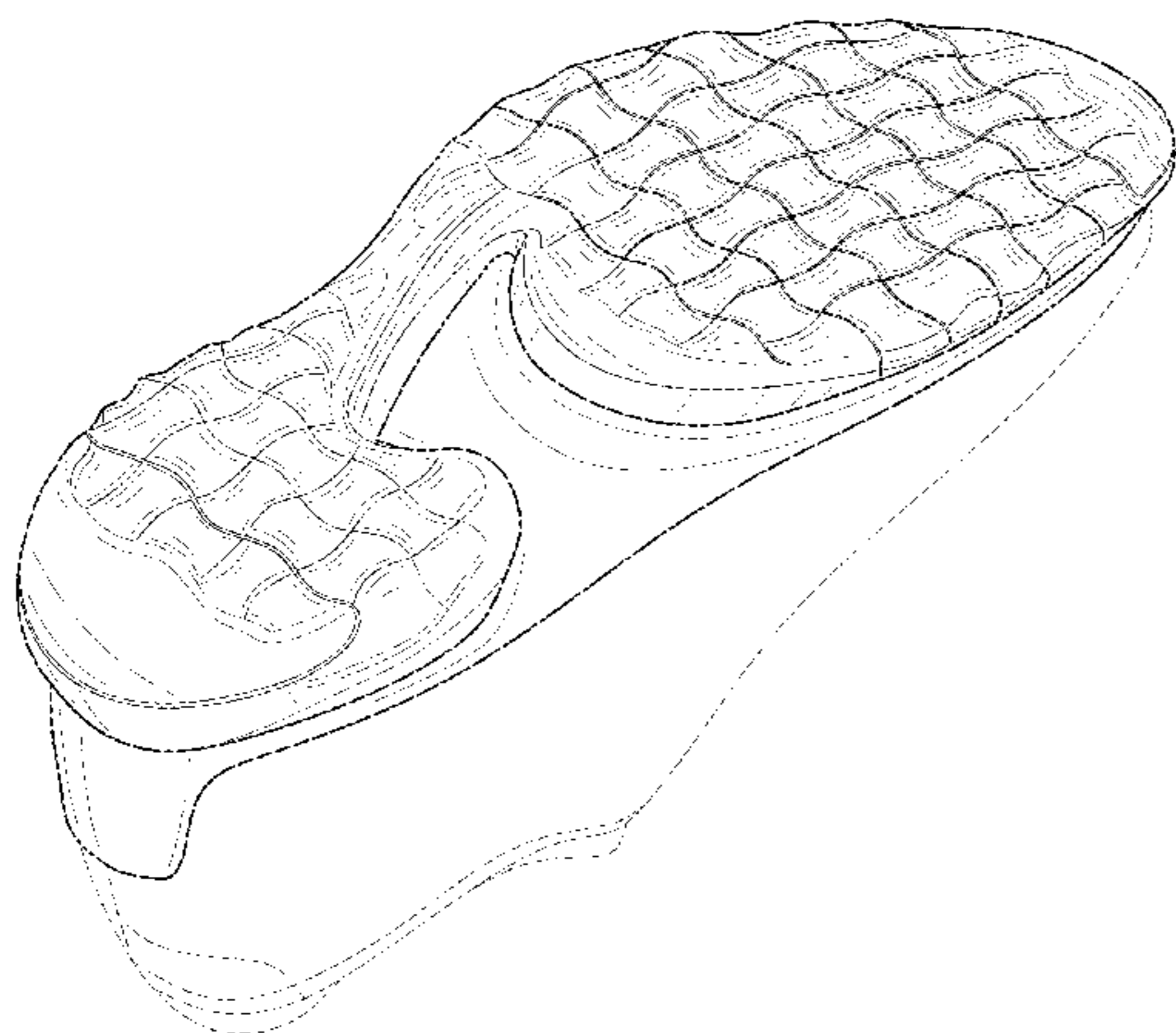

(56)

**References Cited**

U.S. PATENT DOCUMENTS

D613,942	S *	4/2010	Shing .....	D3/232
D616,187	S *	5/2010	Moon .....	D2/951
D618,920	S *	7/2010	Wiwi .....	D5/58
D619,346	S *	7/2010	Moon .....	D2/951
D620,689	S *	8/2010	Weber .....	D2/902
D630,441	S *	1/2011	Wiwi .....	D5/59
D634,129	S *	3/2011	Gerlach .....	D5/57
D640,064	S *	6/2011	Horn .....	A44B 18/0011 D5/59
D640,451	S *	6/2011	Chang .....	D2/917
D765,373	S *	9/2016	Swierszczk .....	D2/951
D792,689	S *	7/2017	Mokos .....	D2/951
D792,690	S *	7/2017	Swierszczk .....	D2/951
D792,691	S *	7/2017	Mokos .....	D2/951
D795,546	S *	8/2017	Kinley .....	D2/951
D808,137	S *	1/2018	Shyllon .....	D2/953
D814,156	S *	4/2018	Mial .....	D2/957
D816,965	S *	5/2018	Christopherson .....	A43B 1/14 D2/960
D818,254	S *	5/2018	Christopherson .....	A43B 3/22 D2/960
2014/0223777	A1 *	8/2014	Whiteman .....	A43B 13/125 36/102
2017/0099907	A1 *	4/2017	Cin .....	A43B 23/0205

\* cited by examiner

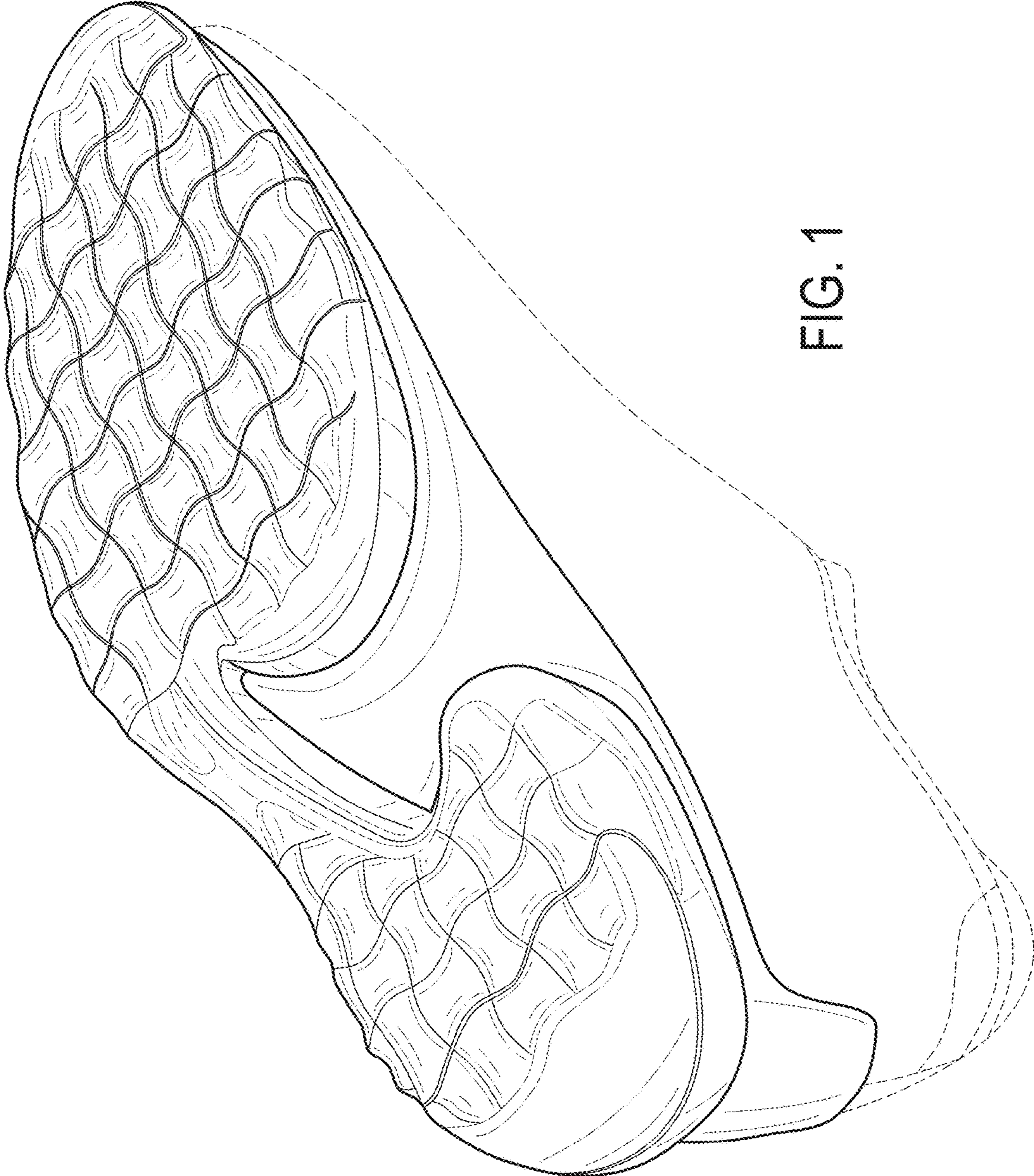

FIG. 1

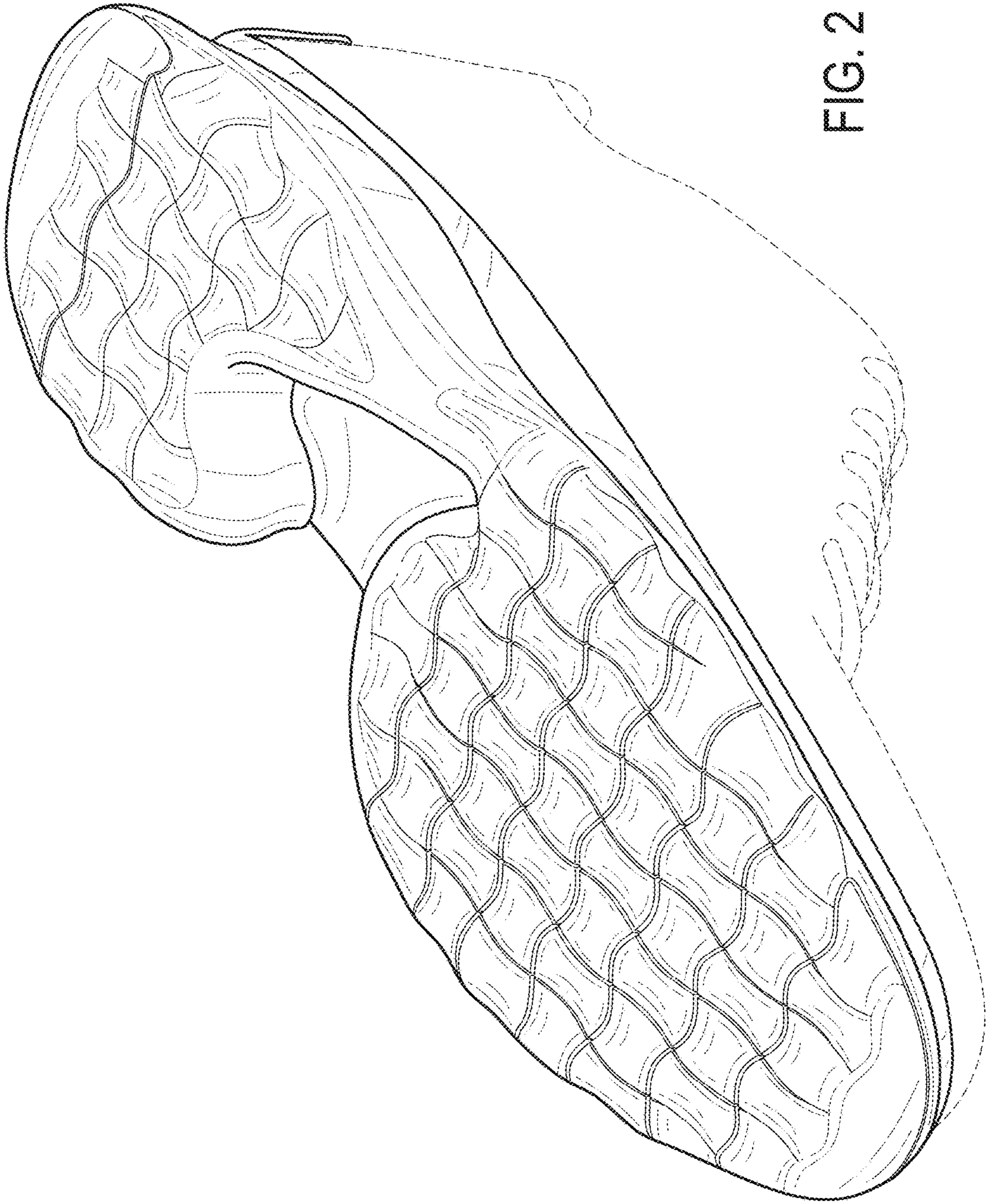

FIG. 2

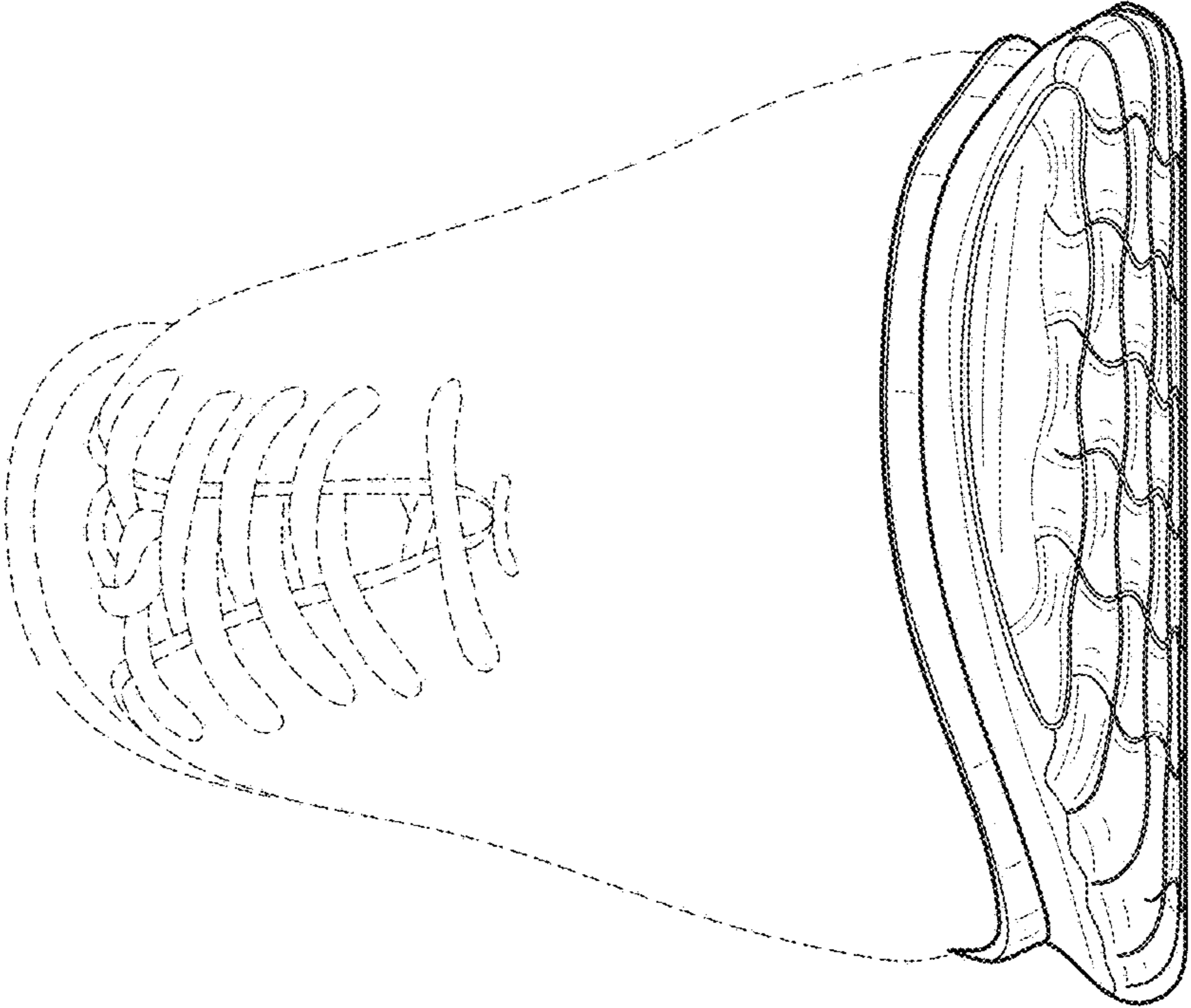

FIG. 3

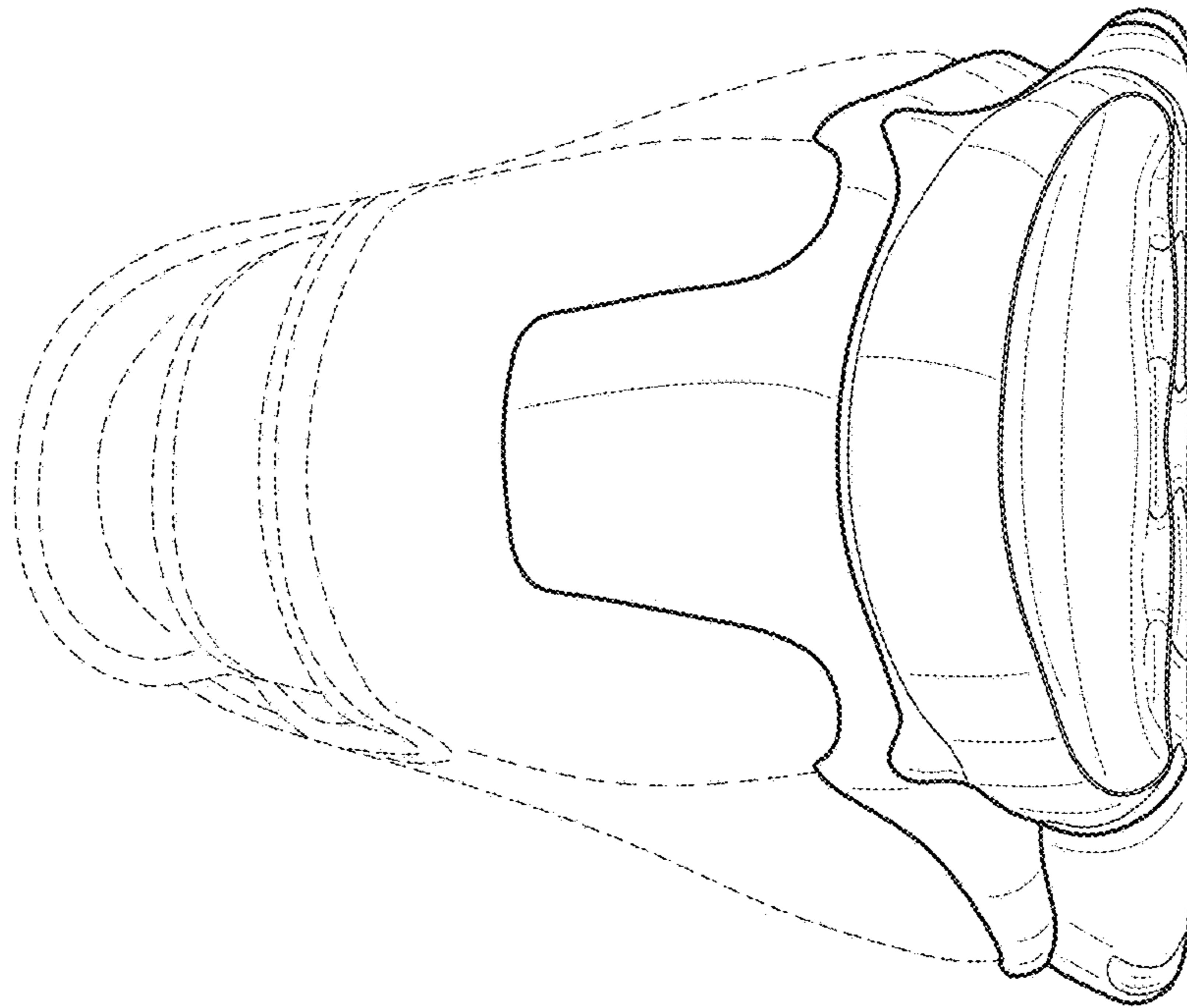

FIG. 4

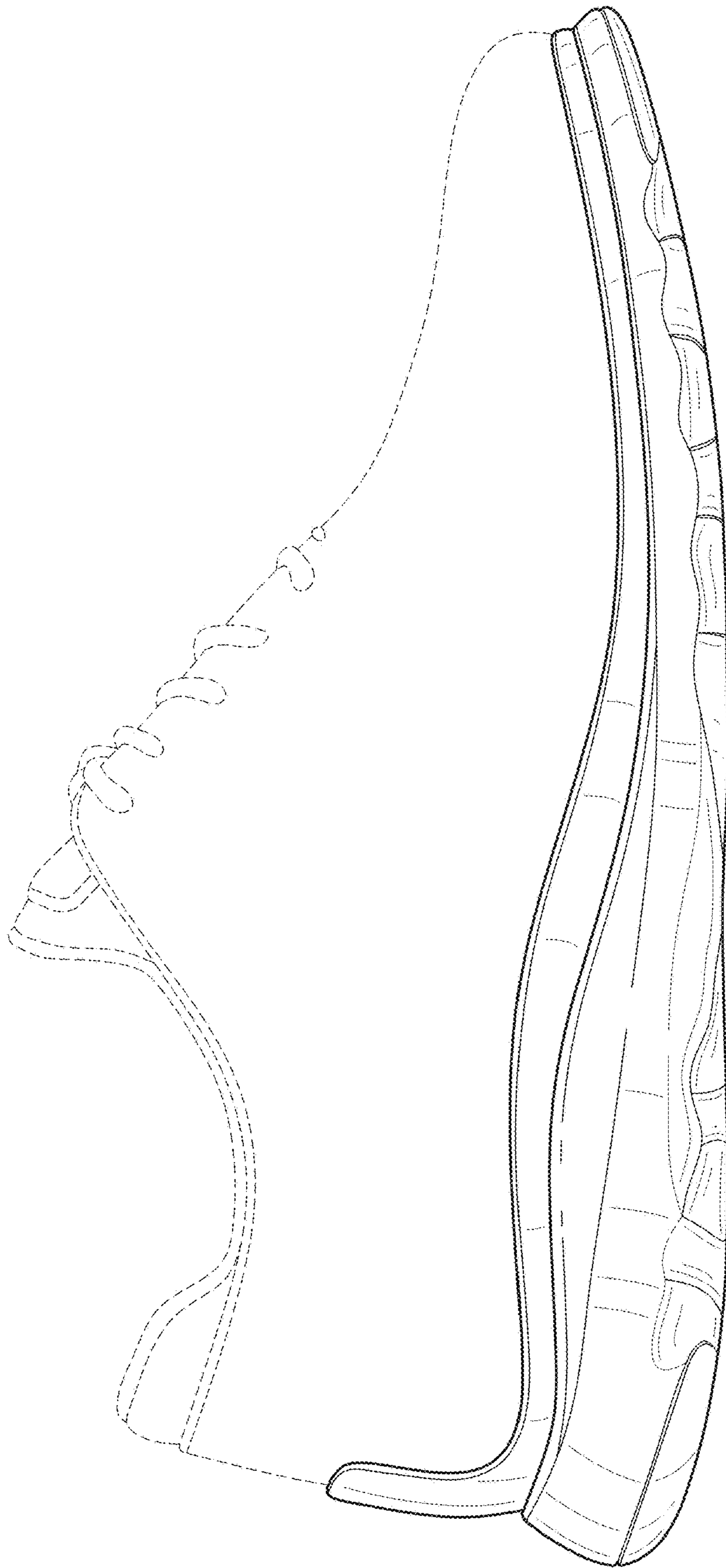

FIG. 5

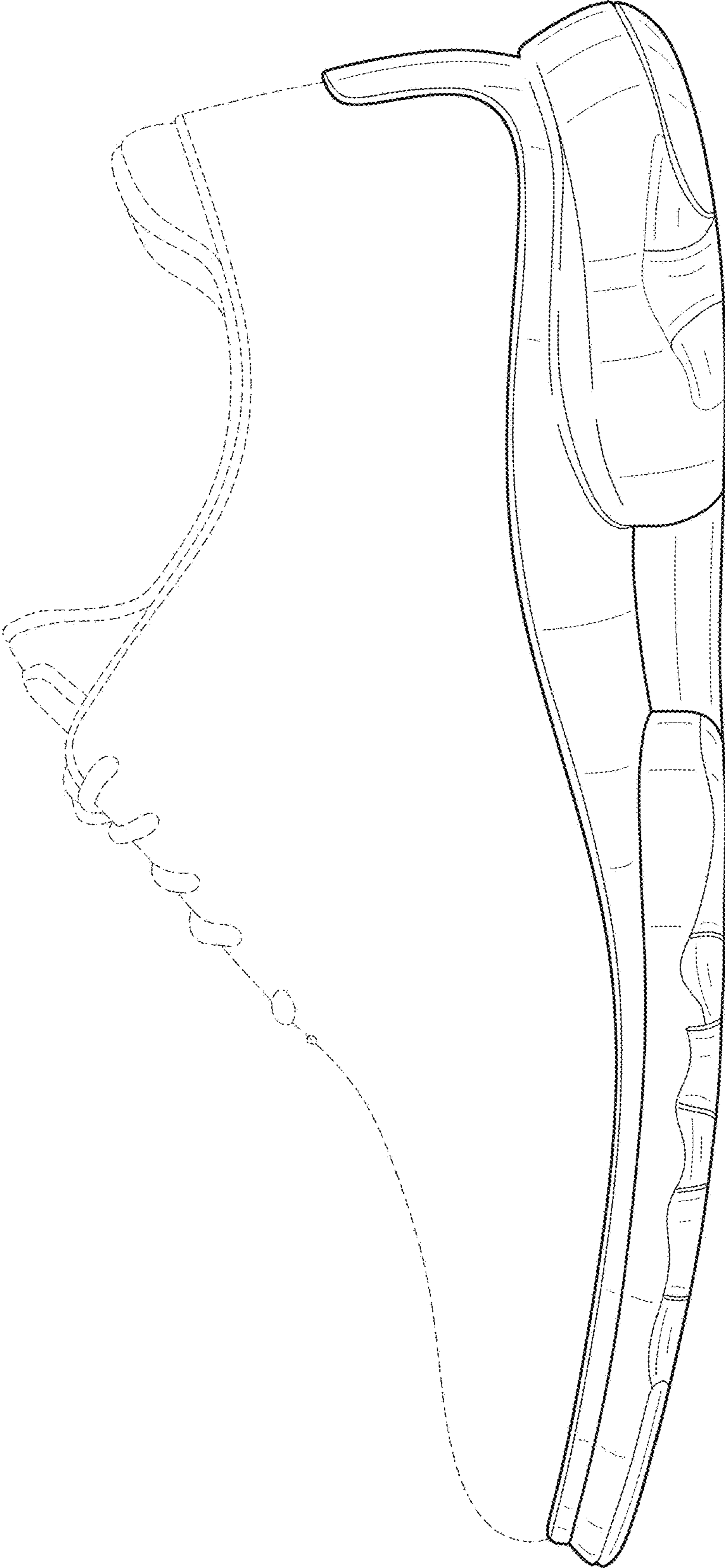

FIG. 6



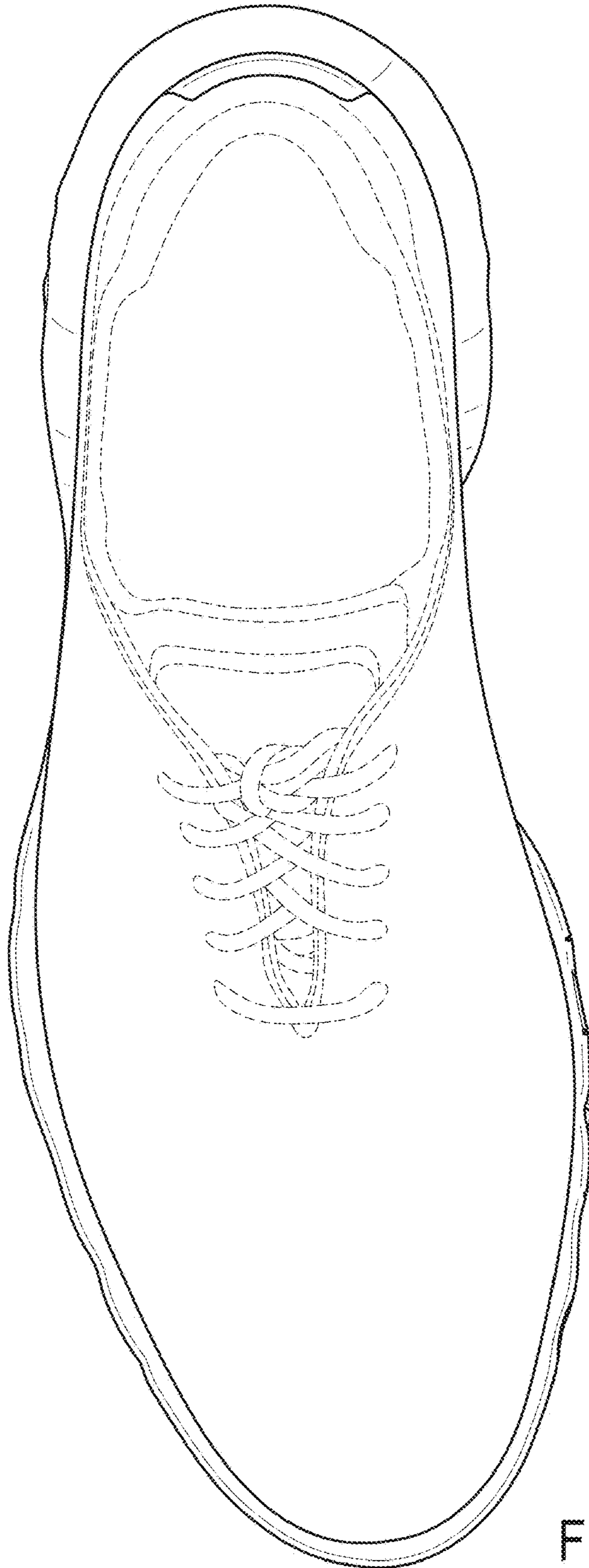

FIG. 7

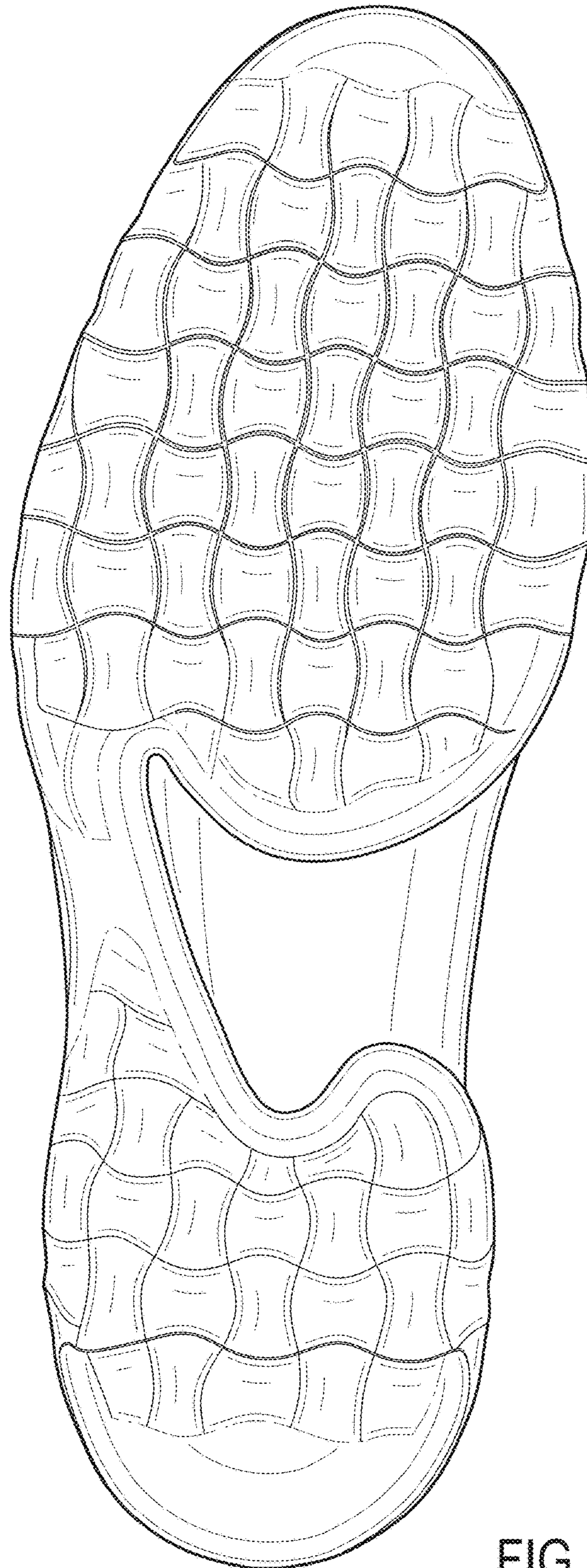

FIG. 8

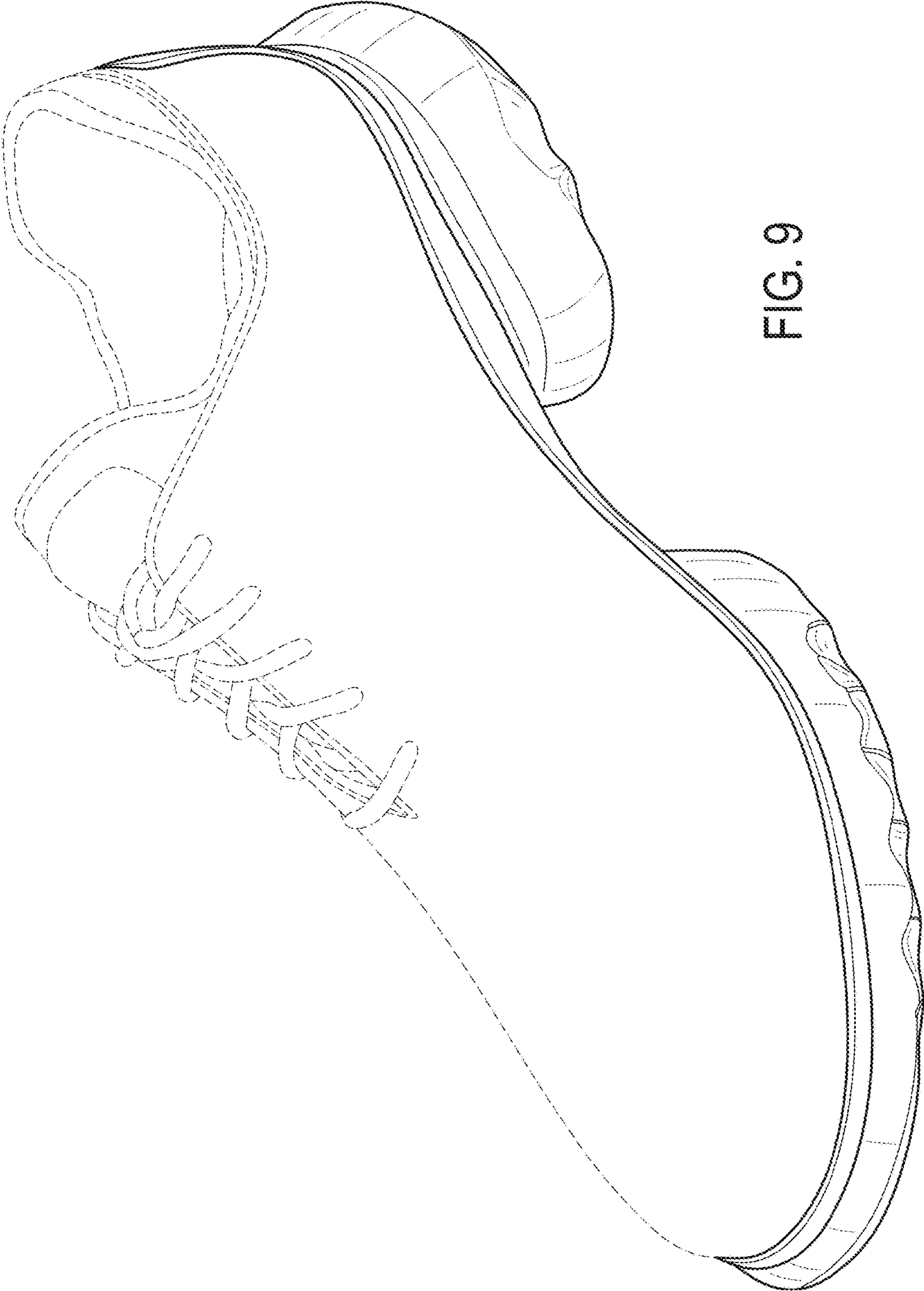

FIG. 9

UNITED STATES PATENT AND TRADEMARK OFFICE  
**CERTIFICATE OF CORRECTION**

PATENT NO. : D854,292 S  
APPLICATION NO. : 29/632345  
DATED : July 23, 2019  
INVENTOR(S) : Mokos et al.

Page 1 of 1

It is certified that error appears in the above-identified patent and that said Letters Patent is hereby corrected as shown below:

On the Title Page

Item (54), "Shoe Soul", should be changed to, "Shoe-Sole".

Signed and Sealed this  
Fifteenth Day of October, 2019

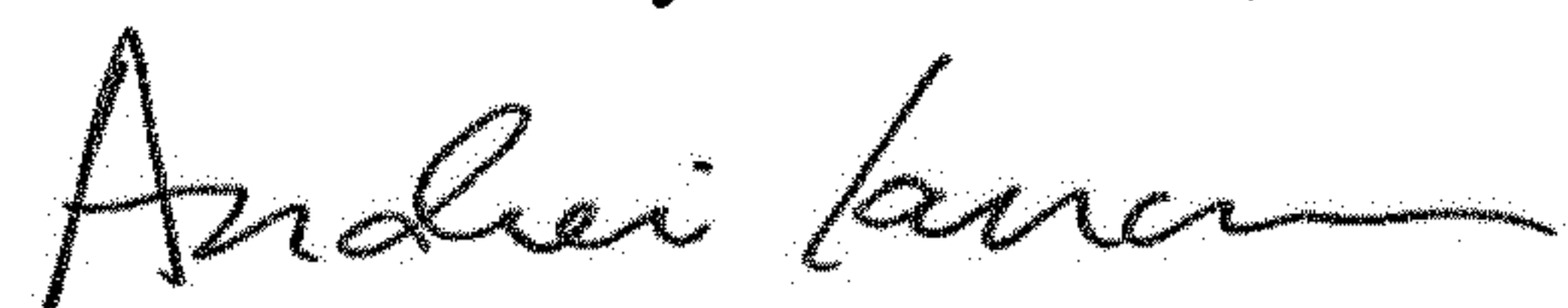

Andrei Iancu  
*Director of the United States Patent and Trademark Office*