



US00D854144S

(12) **United States Design Patent** (10) **Patent No.:** **US D854,144 S**
Bowen (45) **Date of Patent:** **** Jul. 16, 2019**

(54) **EAR LOOP MASK**

(71) Applicant: **Prestige Ameritech, Ltd.**, North Richland Hills, TX (US)

(72) Inventor: **Michael L. Bowen**, North Richland Hills, TX (US)

(73) Assignee: **Prestige Ameritech, Ltd.**, North Richland Hills, TX (US)

(**) Term: **15 Years**

(21) Appl. No.: **29/616,355**

(22) Filed: **Sep. 5, 2017**

(51) **LOC (11) Cl.** **29-02**

(52) **U.S. Cl.**
USPC **D24/110.1**

(58) **Field of Classification Search**
USPC D24/110.1–110.4, 110, 110.5–110.6, 112,
D24/127–128, 164; D29/108

(Continued)

(56) **References Cited**

U.S. PATENT DOCUMENTS

4,941,470 A * 7/1990 Hubbard A41D 13/1115
128/206.13
5,467,765 A * 11/1995 Maturaporn A41D 13/1115
128/206.12

(Continued)

Primary Examiner — Lilyana Bekic

(74) *Attorney, Agent, or Firm* — Betsy Kingsbury Dowd;
BKDowd Law, P.C.

(57) **CLAIM**

The ornamental design for an ear loop mask, as shown and described.

DESCRIPTION

FIG. 1 is a front, left perspective view of a first embodiment of an ear loop mask depicting my new design;

FIG. 2 is a front view of the ear loop mask depicted in FIG. 1;

FIG. 3 is a back view of the ear loop mask depicted in FIG. 1;

FIG. 4 is a bottom view of the ear loop mask depicted in FIG. 1, the top view being a mirror image of the bottom view;

FIG. 5 is a left end view of the ear loop mask depicted in FIG. 1; and

FIG. 6 is a right end view of the ear loop mask depicted in FIG. 1; and

FIG. 7 is a front, left perspective view of a second embodiment of an ear loop mask depicting our new design;

FIG. 8 is a front view of the ear loop mask depicted in FIG. 7;

FIG. 9 is a back view of the ear loop mask depicted in FIG. 7;

FIG. 10 is a bottom view of the ear loop mask depicted in FIG. 7, the top view being a mirror image of the bottom view;

FIG. 11 is a left end view of the ear loop mask depicted in FIG. 7; and

FIG. 12 is a right end view of the ear loop mask depicted in FIG. 7; and

FIG. 13 is a front, left perspective view of a third embodiment of an ear loop mask depicting our new design;

FIG. 14 is a front view of the ear loop mask depicted in FIG. 13;

FIG. 15 is a back view of the ear loop mask depicted in FIG. 13;

FIG. 16 is a bottom view of the ear loop mask depicted in FIG. 13, the top view being a mirror image of the bottom view;

FIG. 17 is a left end view of the ear loop mask depicted in FIG. 13; and

FIG. 18 is a right end view of the ear loop mask depicted in FIG. 13; and

FIG. 19 is a front, left perspective view of a fourth embodiment of an ear loop mask depicting our new design;

FIG. 20 is a front view of the ear loop mask depicted in FIG. 19;

FIG. 21 is a back view of the ear loop mask depicted in FIG. 19;

(Continued)

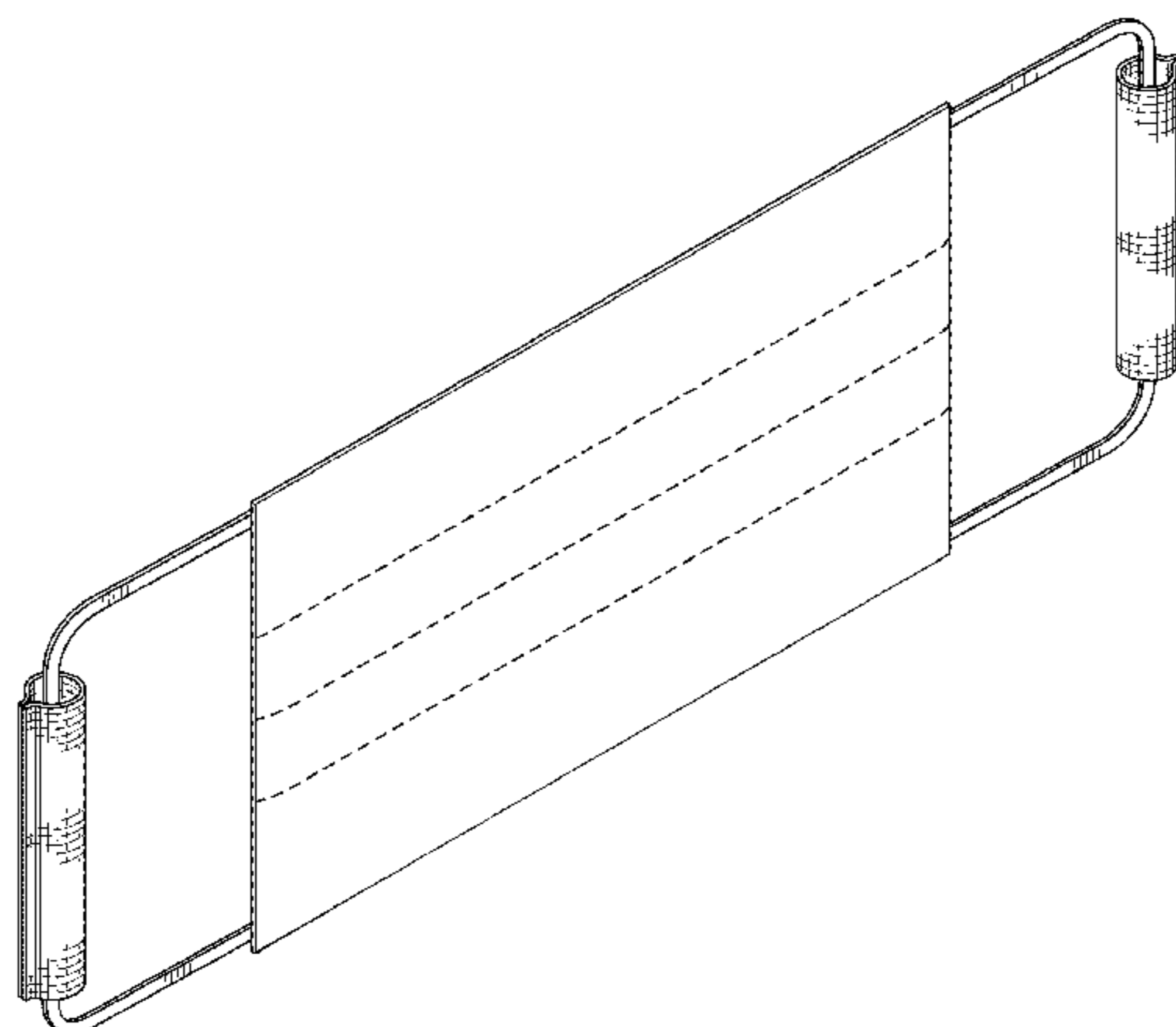

FIG. 22 is a bottom view of the ear loop mask depicted in FIG. 19, the top view being a mirror image of the bottom view;

FIG. 23 is a left end view of the ear loop mask depicted in FIG. 19; and,

FIG. 24 is a right end view of the ear loop mask depicted in FIG. 19.

The broken line showing of pleats in FIGS. 1-4, 7-10, 13-16, and 19-22, and the broken line showing of the inside seam of the sleeves around the ear loops in FIGS. 19 and 22 depict portions of the ear loop mask and form no part of the claimed design. The unshaded surfaces adjacent the broken line showing of the pleats in FIGS. 1-4, 7-10, 13-16, and 19-22 likewise form no part of the claimed design.

1 Claim, 16 Drawing Sheets

(58) **Field of Classification Search**

CPC A61M 16/06; A61M 16/0683; A61M 16/0816; A61M 16/0875; A61M 16/208; A61M 16/00; A62B 18/02; A62B 18/10; A62B 18/025; A62B 23/025; A62B 7/10; A41D 13/11; A41D 13/1107; A41D 13/1115; A41D 13/113; A41D 13/1161

See application file for complete search history.

(56) **References Cited**

U.S. PATENT DOCUMENTS

5,699,792 A * 12/1997 Reese A41D 13/1115
128/206.19
5,727,544 A * 3/1998 Miura A41D 13/11
128/201.13
5,813,398 A * 9/1998 Baird A41D 13/1115
128/201.15
D400,674 S * 11/1998 Miura D24/110.1

5,954,055 A * 9/1999 Miyake A41D 13/1115
128/206.12
6,412,486 B1 * 7/2002 Glass A41D 13/11
128/205.27
D464,726 S * 10/2002 Wolfe D24/110.1
8,251,065 B2 * 8/2012 Kim A62B 23/025
128/206.19
D693,062 S * 11/2013 Bowen D29/108
2004/0163649 A1 * 8/2004 Shao A41D 13/1192
128/205.27
2006/0174890 A1 * 8/2006 Cheng A41D 13/11
128/206.19
2009/0084384 A1 * 4/2009 Cheng A41D 13/11
128/206.19
2009/0145434 A1 * 6/2009 Herrmann A61M 16/06
128/203.29
2009/0205666 A1 * 8/2009 Bowen A41D 13/1107
128/206.13
2012/0192876 A1 * 8/2012 Fujimori A62B 23/025
128/863
2014/0215696 A1 * 8/2014 Polit A41D 13/11
2/423
2014/0237695 A1 * 8/2014 Al Malki A41D 13/11
2/9
2014/0326255 A1 * 11/2014 Teng A41D 13/1115
128/863
2015/0056102 A1 * 2/2015 Yamada B01D 39/16
422/120
2015/0306432 A1 * 10/2015 Orofino A41D 13/1115
128/863
2015/0335080 A1 * 11/2015 Giles A41D 13/1115
128/863
2016/0029715 A1 * 2/2016 Zheng A41D 13/11
128/863
2016/0151650 A1 * 6/2016 Reese A62B 23/025
128/863
2017/0013894 A1 * 1/2017 Lee A41D 13/1107
2017/0106217 A1 * 4/2017 Kuhn A41D 13/1192
2017/0209719 A1 * 7/2017 Tang A62B 23/025
2017/0367416 A1 * 12/2017 Yamada A62B 18/02
2018/0000173 A1 * 1/2018 Tsaor G10K 11/24
2018/0110945 A1 * 4/2018 Cheng A41D 13/11

* cited by examiner

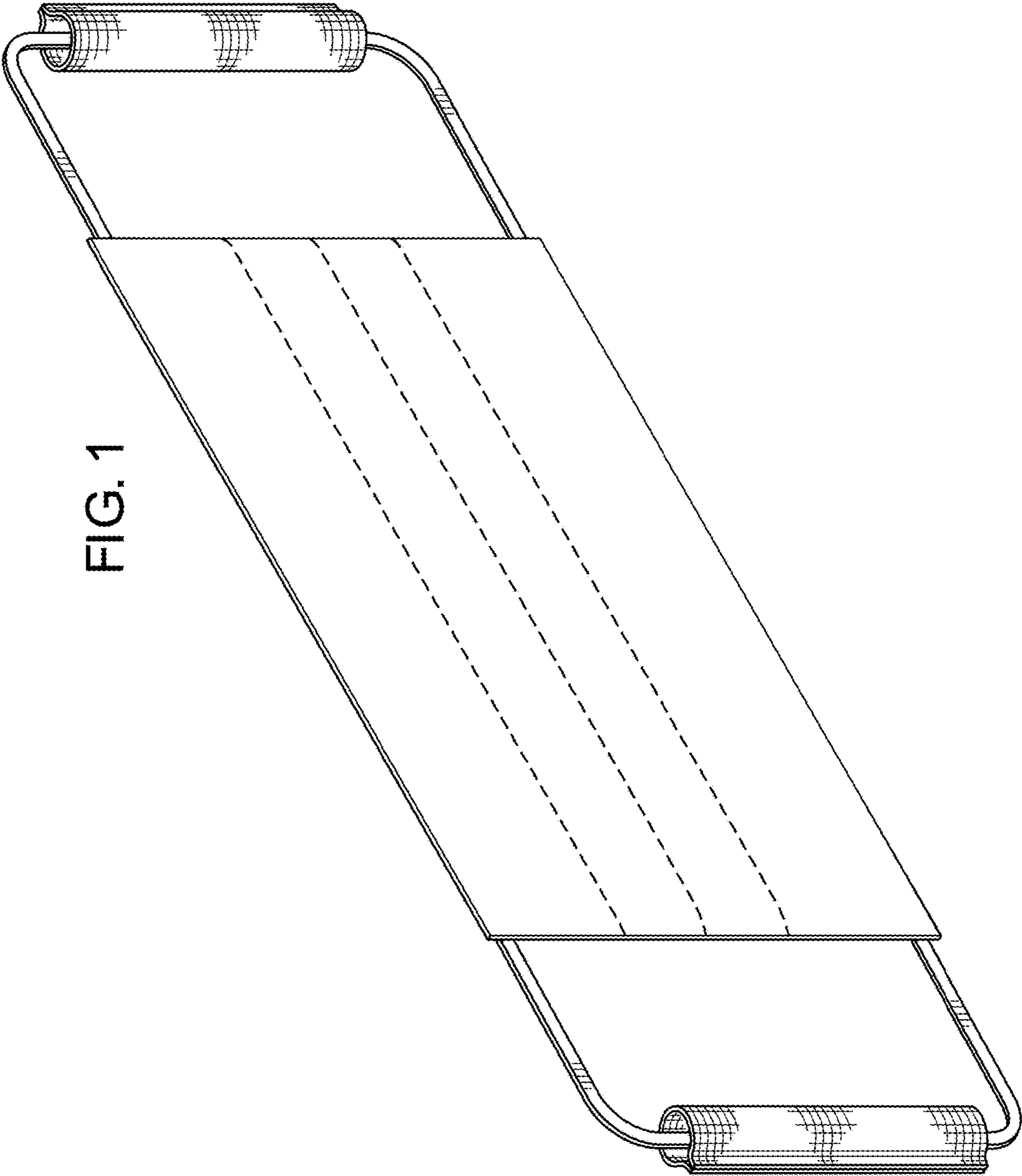

FIG. 1

FIG. 2

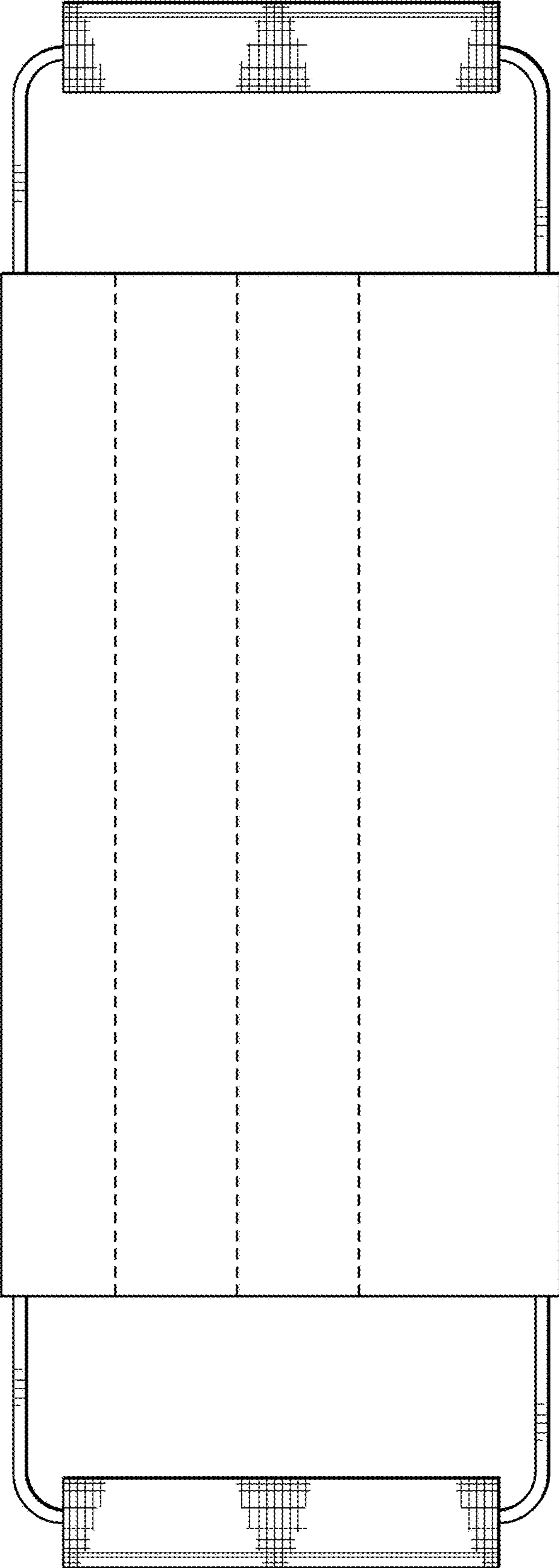

FIG. 3

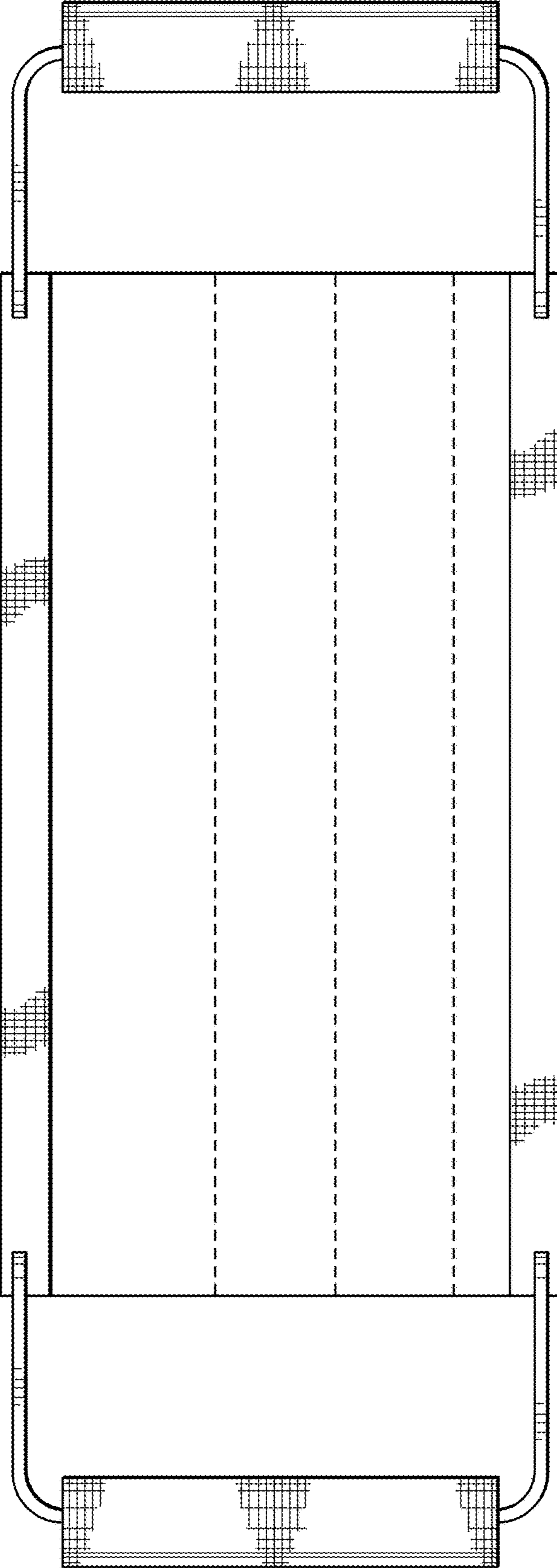

FIG. 4

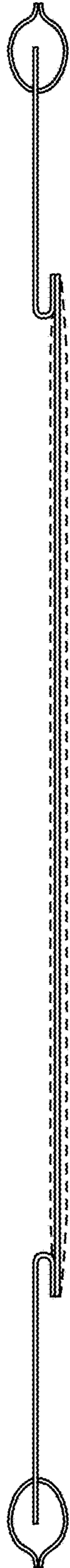

FIG. 5



FIG. 6



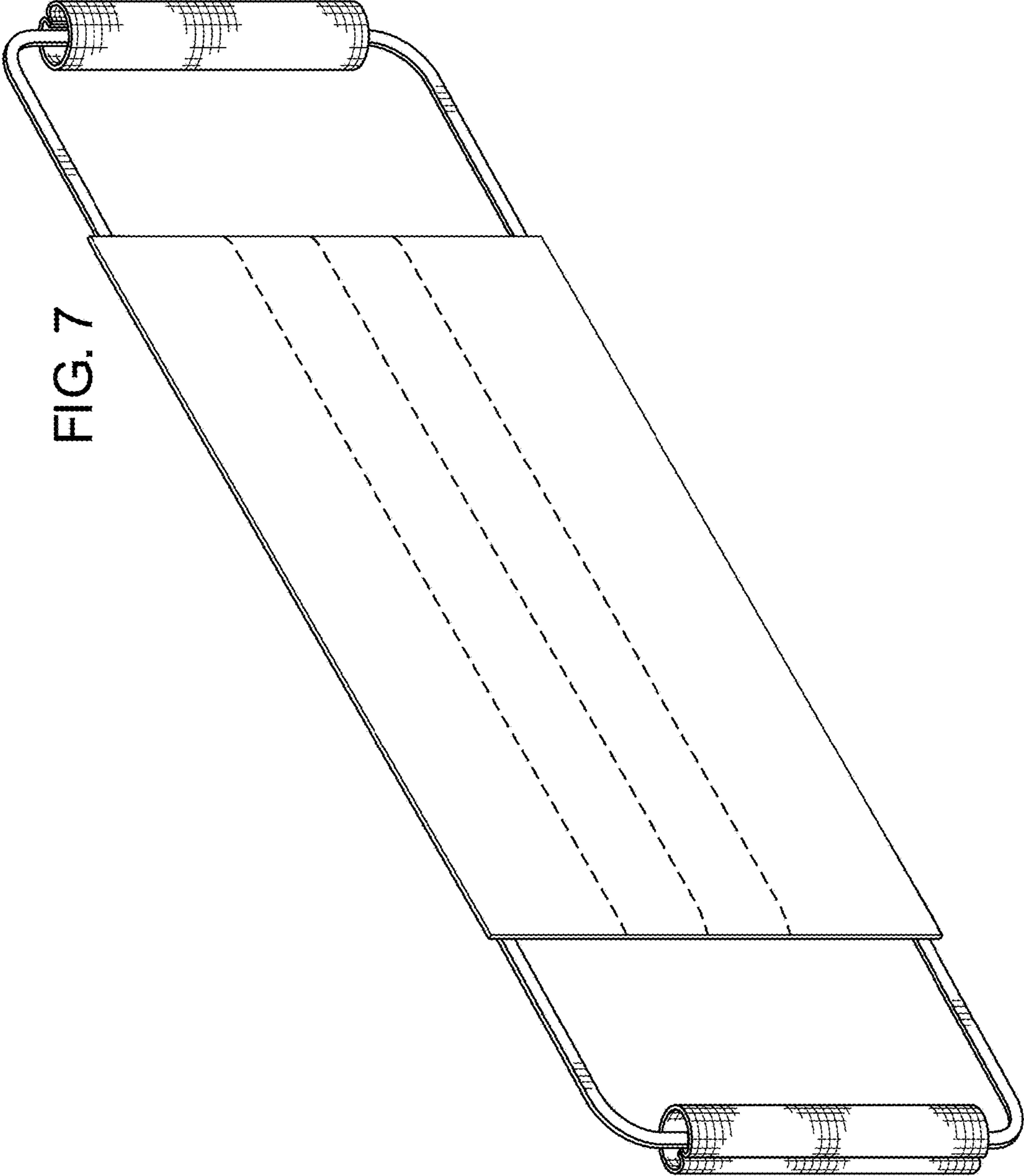

FIG. 7

FIG. 8

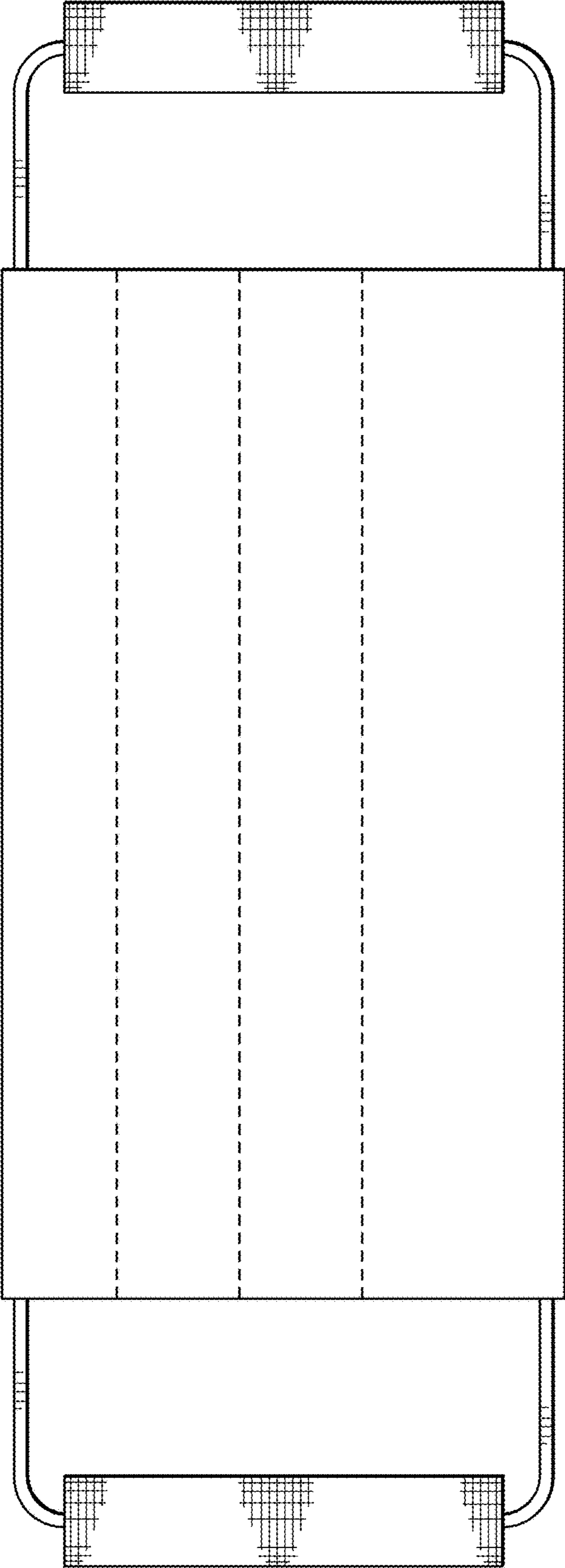

FIG. 9

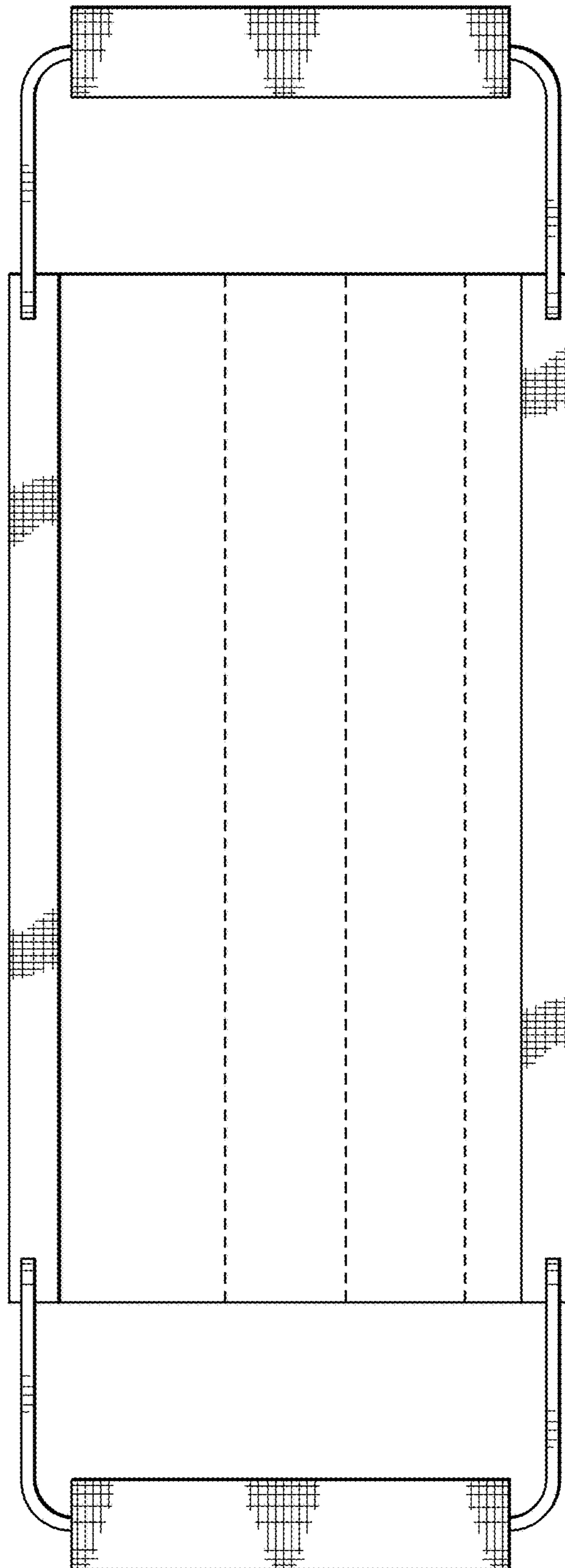

FIG. 10

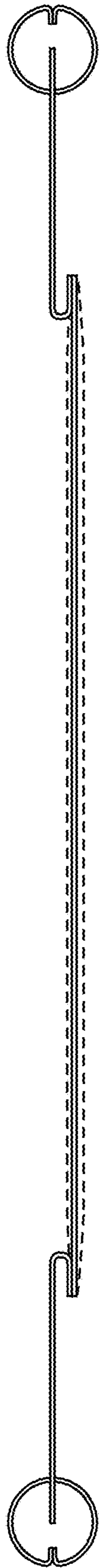

FIG. 12

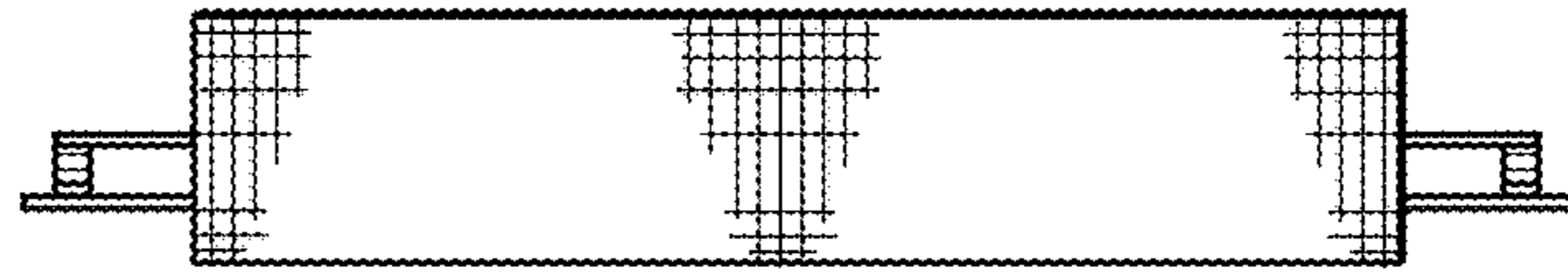
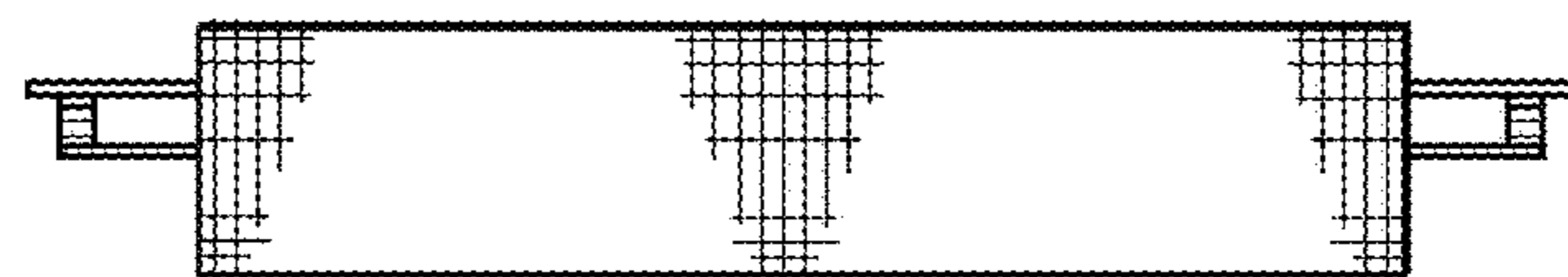

FIG. 11



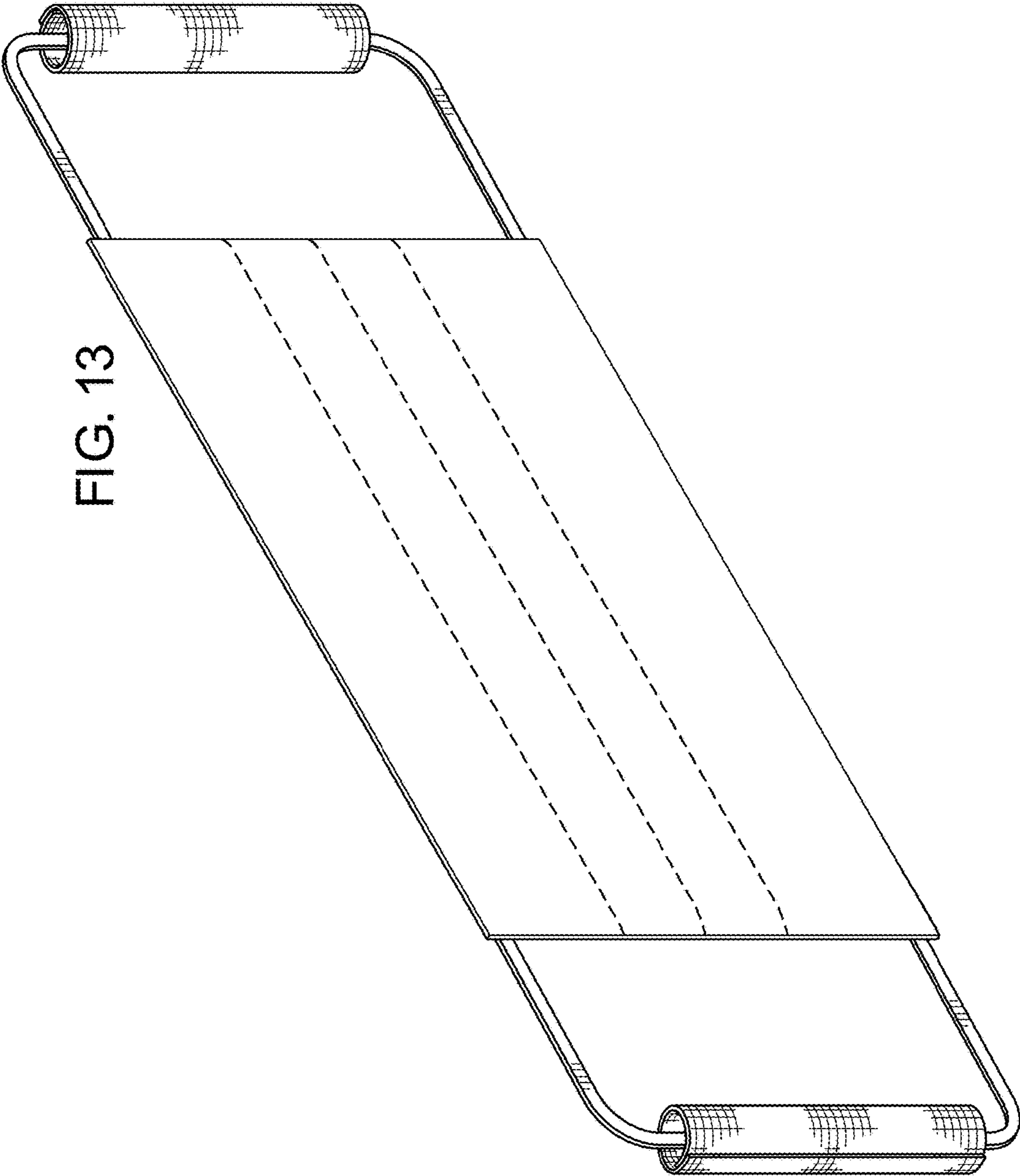

FIG. 13

FIG. 14

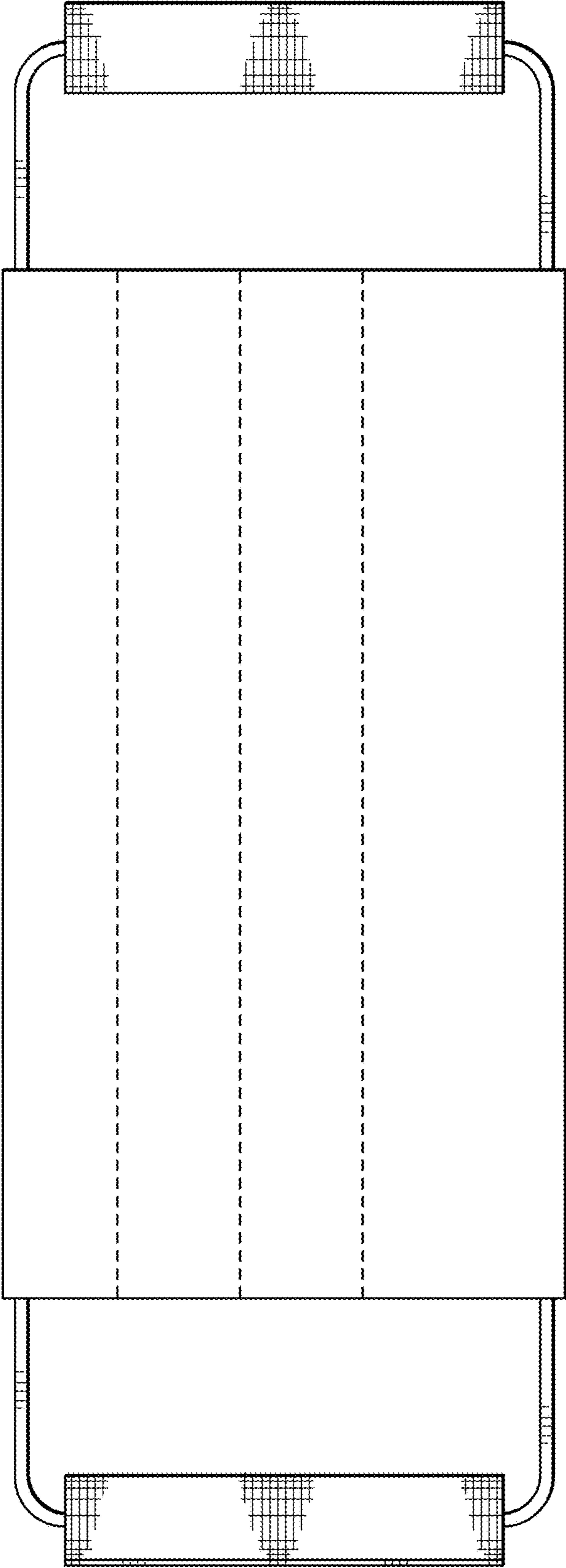

FIG. 15

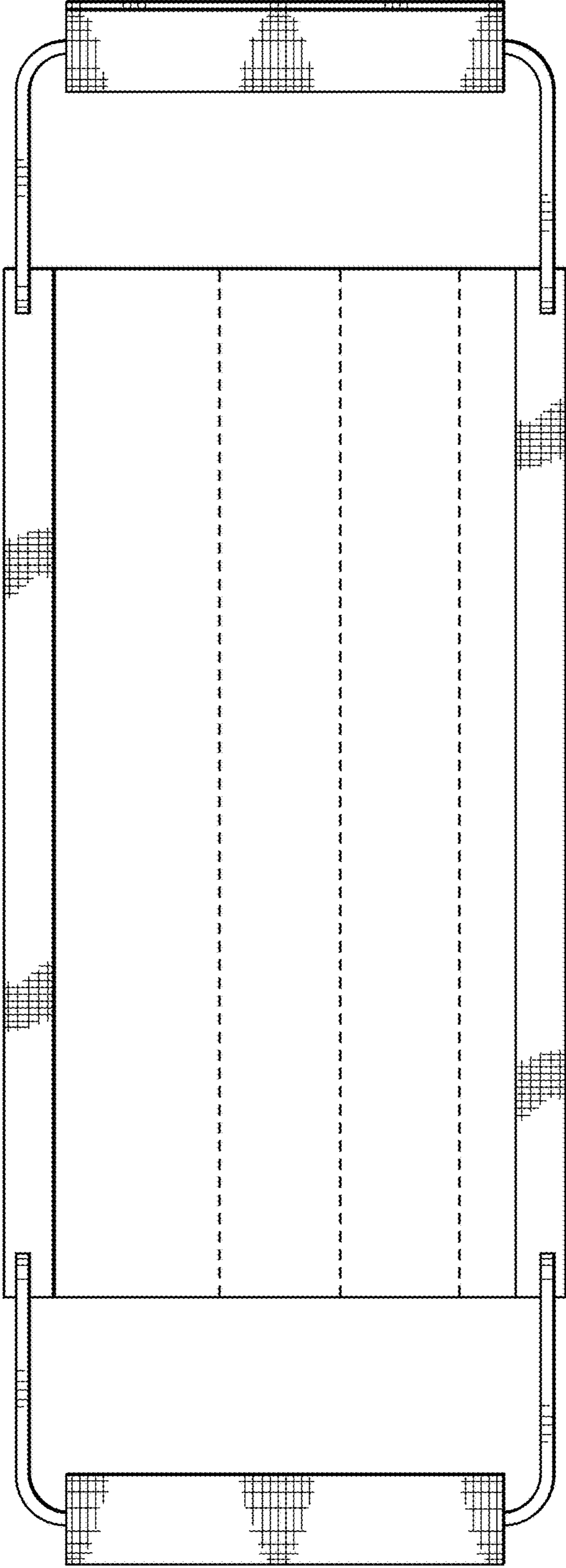

FIG. 16

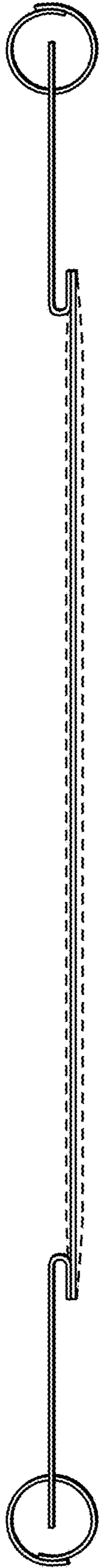

FIG. 17

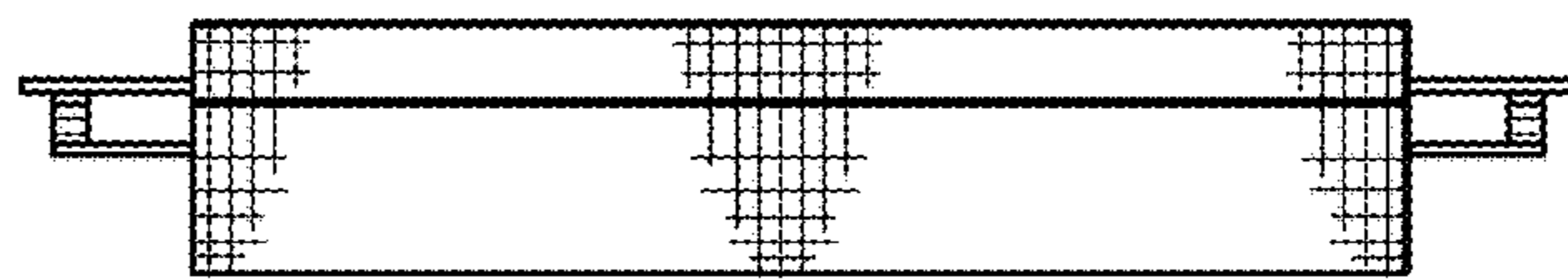
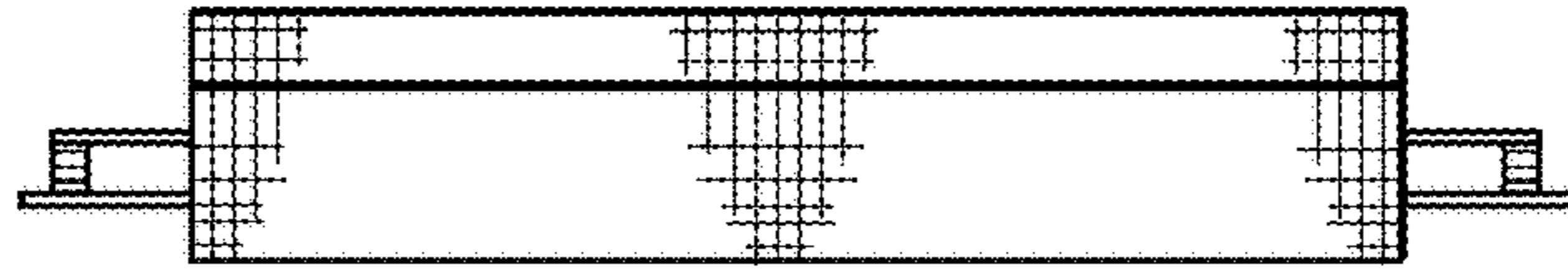

FIG. 18



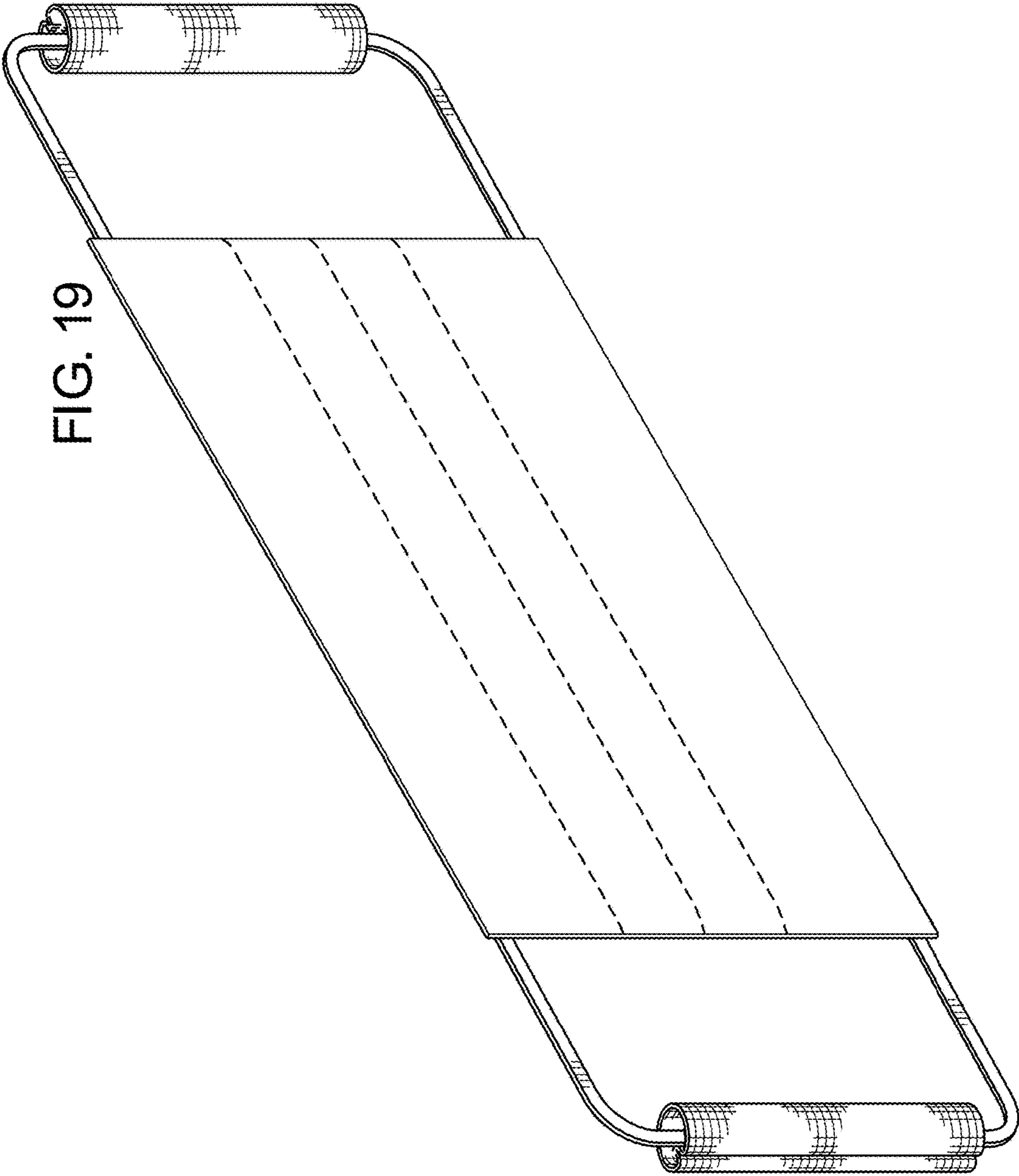

FIG. 19

FIG. 20

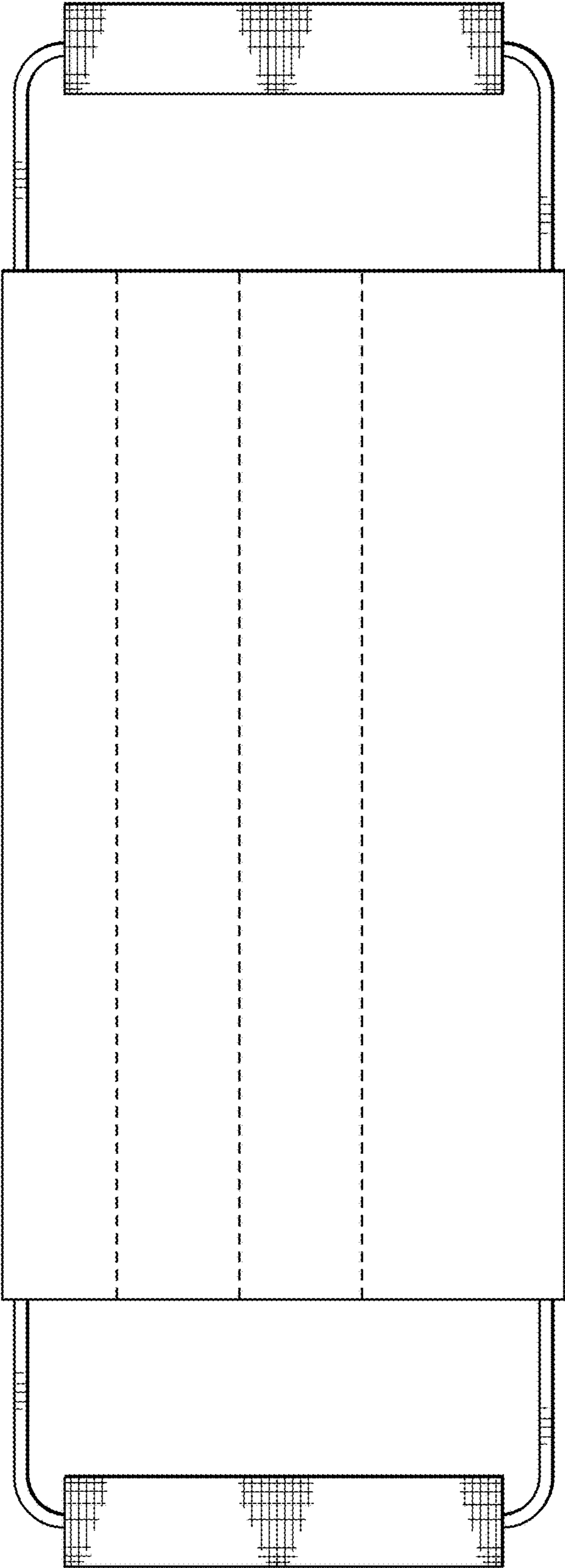

FIG. 21

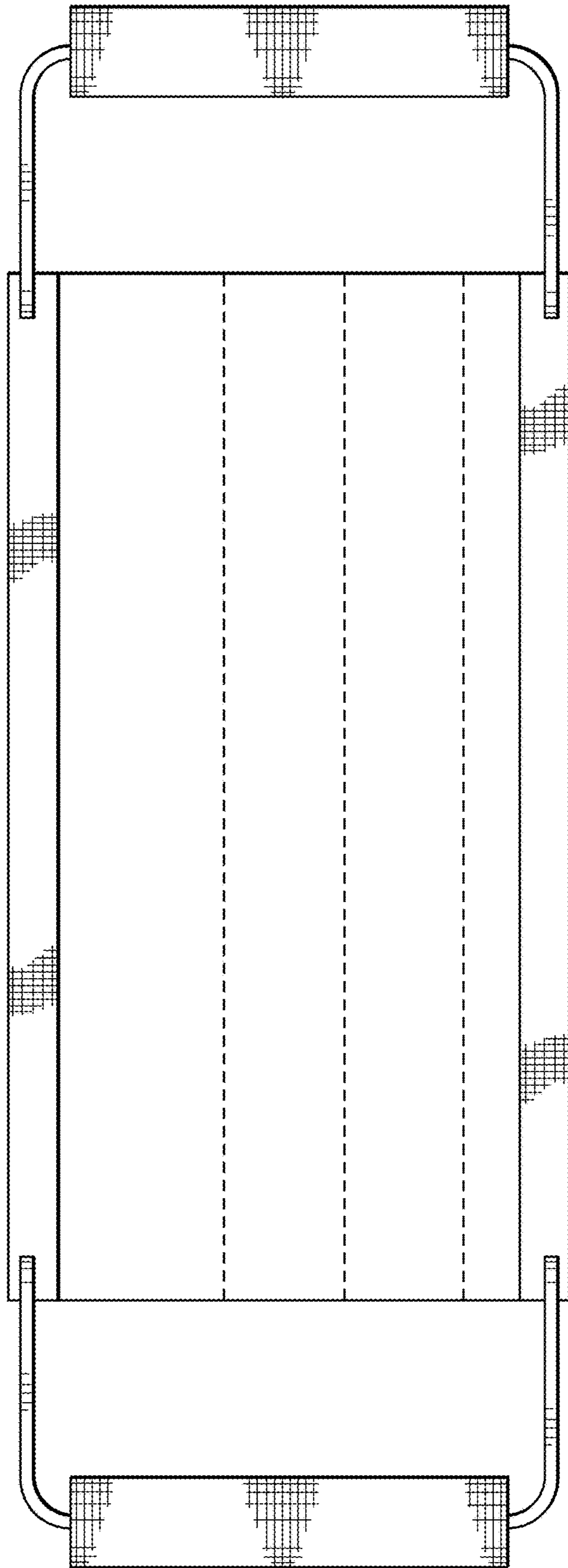

FIG. 22

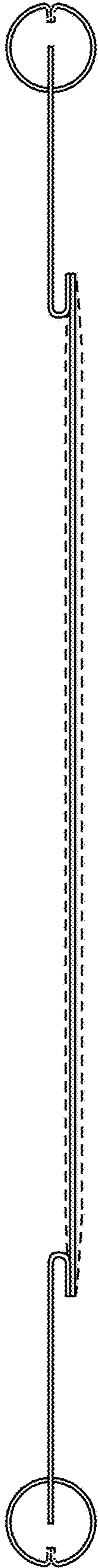

FIG. 24

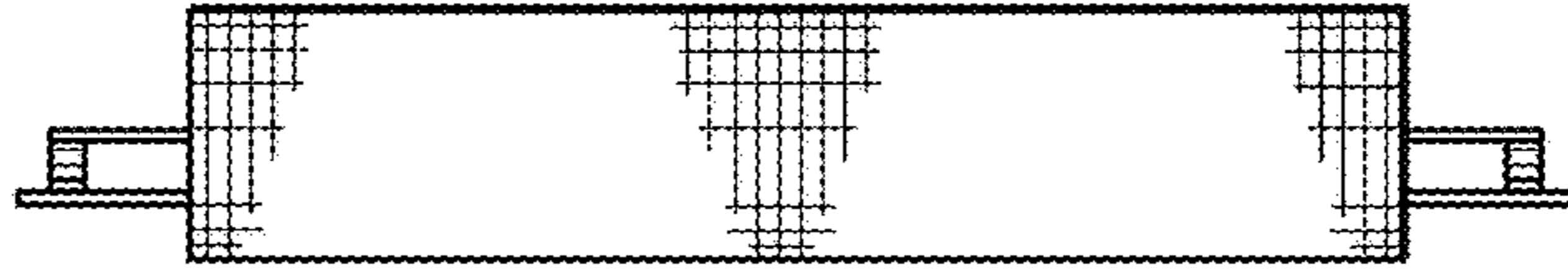

FIG. 23

