

US00D854086S

(12) **United States Design Patent**
Mitchell

(10) **Patent No.:** **US D854,086 S**

(45) **Date of Patent:** **** Jul. 16, 2019**

(54) **PEN STAND**

(71) Applicant: **Wacom Co., Ltd.**, Kazo-shi, Saitama (JP)

(72) Inventor: **Giles Thomas Mitchell**, Setagaya-ku (JP)

(73) Assignee: **Wacom Co., Ltd.**, Kazo-shi (JP)

(**) Term: **15 Years**

(21) Appl. No.: **29/608,136**

(22) Filed: **Jun. 19, 2017**

(30) **Foreign Application Priority Data**

Dec. 21, 2016 (JP) 2016-027750

(51) **LOC (11) Cl.** **19-06**

(52) **U.S. Cl.**
USPC **D19/83**

(58) **Field of Classification Search**
USPC D19/32, 75, 77-85, 135; D3/315, 901;
D6/677.3; D7/590, 641; D9/415, 457,
D9/722; D28/73

(Continued)

(56) **References Cited**

U.S. PATENT DOCUMENTS

D45,779 S * 5/1914 Weeks D19/79
1,218,663 A * 3/1917 James B43L 25/002
15/257.074

(Continued)

FOREIGN PATENT DOCUMENTS

JP D801877 S 12/1990
JP D1318211 S 12/2007
JP D1390714 S 6/2010

Primary Examiner — Elizabeth A. Albert

(74) *Attorney, Agent, or Firm* — Christensen O'Connor Johnson Kindness PLLC

(57) **CLAIM**

The ornamental design for a pen stand, as shown and described.

DESCRIPTION

FIG. 1 is a top front right perspective view of a pen stand showing my new design;
FIG. 2 is a bottom front left perspective view of FIG. 1;
FIG. 3 is a front elevation view of FIG. 1;
FIG. 4 is a rear elevation view of FIG. 1;
FIG. 5 is a left side elevation view of FIG. 1;
FIG. 6 is a top plan view of FIG. 1;
FIG. 7 is a bottom plan view of FIG. 1;
FIG. 8 is a top front right perspective view of a first portion of FIG. 1, shown without a second portion for convenience;
FIG. 9 is a bottom front left perspective view FIG. 8;
FIG. 10 is a front elevation view of FIG. 8;
FIG. 11 is a rear elevation view of FIG. 8;
FIG. 12 is a left side elevation view of FIG. 8, wherein the right side elevation view is a mirror image of the left side elevation view;
FIG. 13 is a top plan view of FIG. 8;
FIG. 14 is a bottom plan view FIG. 8;
FIG. 15 is a top front right perspective view of the second portion of FIG. 1, shown without the first portion for convenience;
FIG. 16 is a front elevation view of FIG. 15;
FIG. 17 is a rear elevation view of FIG. 15;
FIG. 18 is a left side elevation view of FIG. 15;
FIG. 19 is a right side elevation view of FIG. 15;
FIG. 20 is a top plan view of FIG. 15;
FIG. 21 is a bottom plan view of FIG. 15; and,
FIG. 22 is a bottom front left perspective view of FIG. 1, with the second portion removed and a plurality of pen nibs disposed therein.
The evenly spaced broken lines in FIGS. 1-22 show nibs and portions of the pen stand that form no part of the claimed design. The long and short broken lines in FIGS. 9, 14 and 22 define the bounds of the claimed design and form no part thereof.

1 Claim, 12 Drawing Sheets

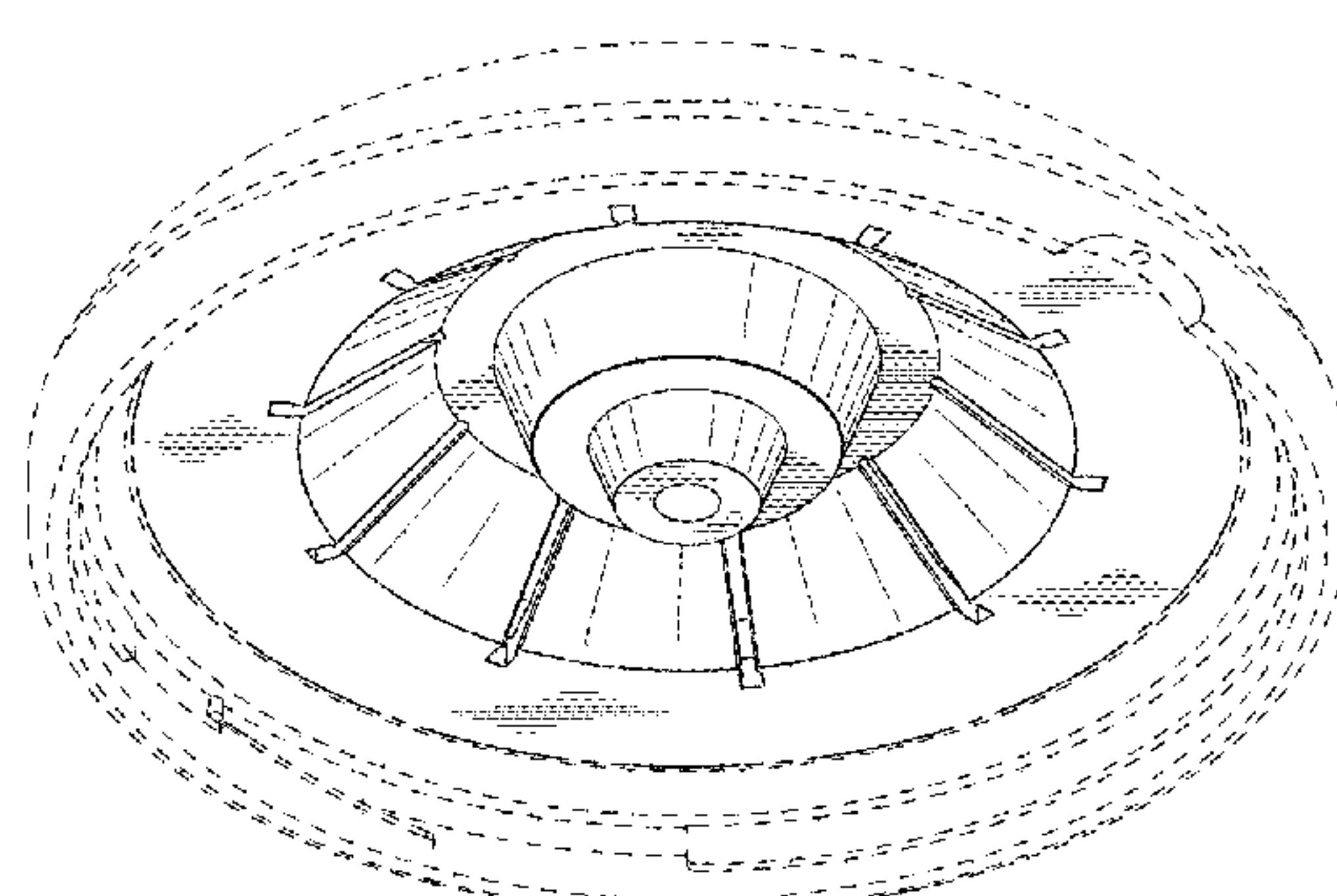
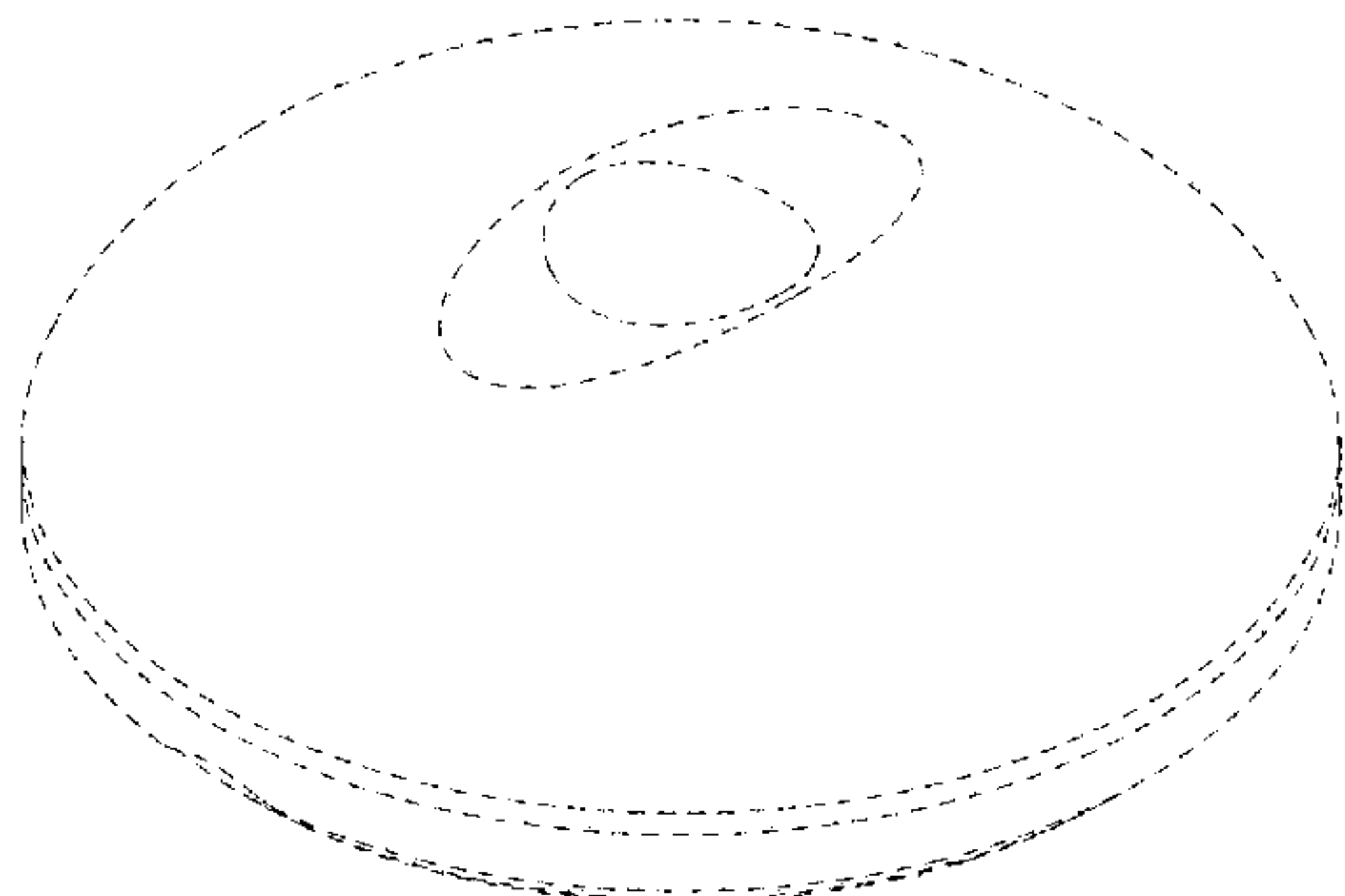

(58) **Field of Classification Search**

CPC .. B43K 23/001; B43K 23/002; B43K 23/004;
B43K 23/008; B43K 23/012; B43K
23/016; B43K 23/04; B43M 99/006;
B43M 99/008

See application file for complete search history.

(56) **References Cited**

U.S. PATENT DOCUMENTS

D181,114 S * 10/1957 Turner D19/84
D184,031 S * 12/1958 Steinberg D19/84
2,956,544 A * 10/1960 McDonald B43M 9/00
16/403
4,865,285 A * 9/1989 Gaggianese B43M 99/004
248/309.4
D310,688 S * 9/1990 Windorski D19/75
D316,112 S * 4/1991 Windorski D19/75
D342,096 S * 12/1993 Cornell D19/86
5,839,712 A * 11/1998 Wang B43M 99/003
248/316.2
D405,471 S * 2/1999 Carlson D19/86
D504,157 S * 4/2005 Huang D19/75
D525,306 S * 7/2006 Hirota D19/84
D570,416 S * 6/2008 Hackenberg D19/83
D643,879 S * 8/2011 Rashid D19/86
D660,518 S * 5/2012 Chen D28/73
D669,133 S * 10/2012 Dalton B25C 7/00
D19/75
D761,488 S * 7/2016 Alarcon D27/135
2018/0154679 A1 * 6/2018 Mitchell B43K 8/22

* cited by examiner

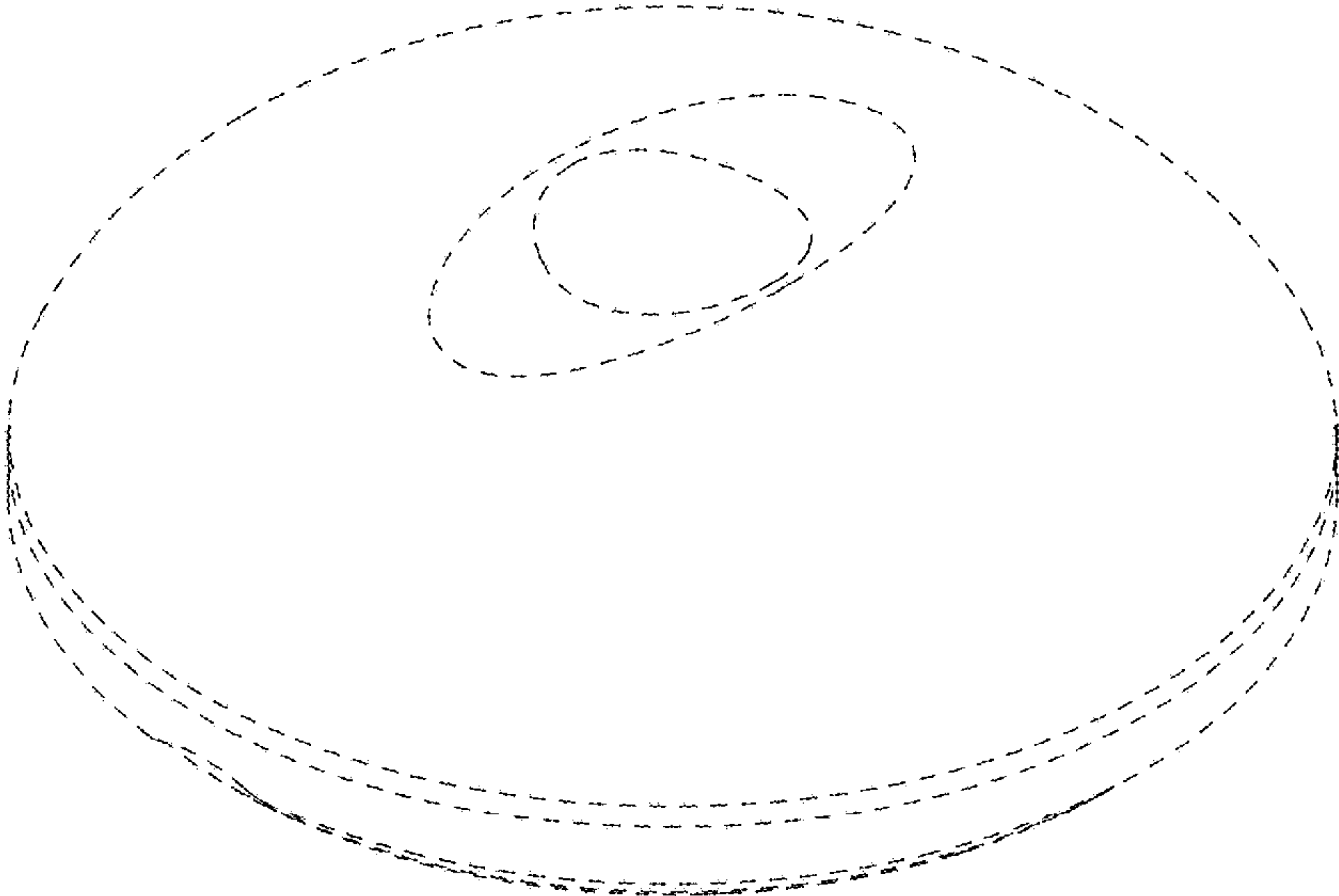

Fig. 1.

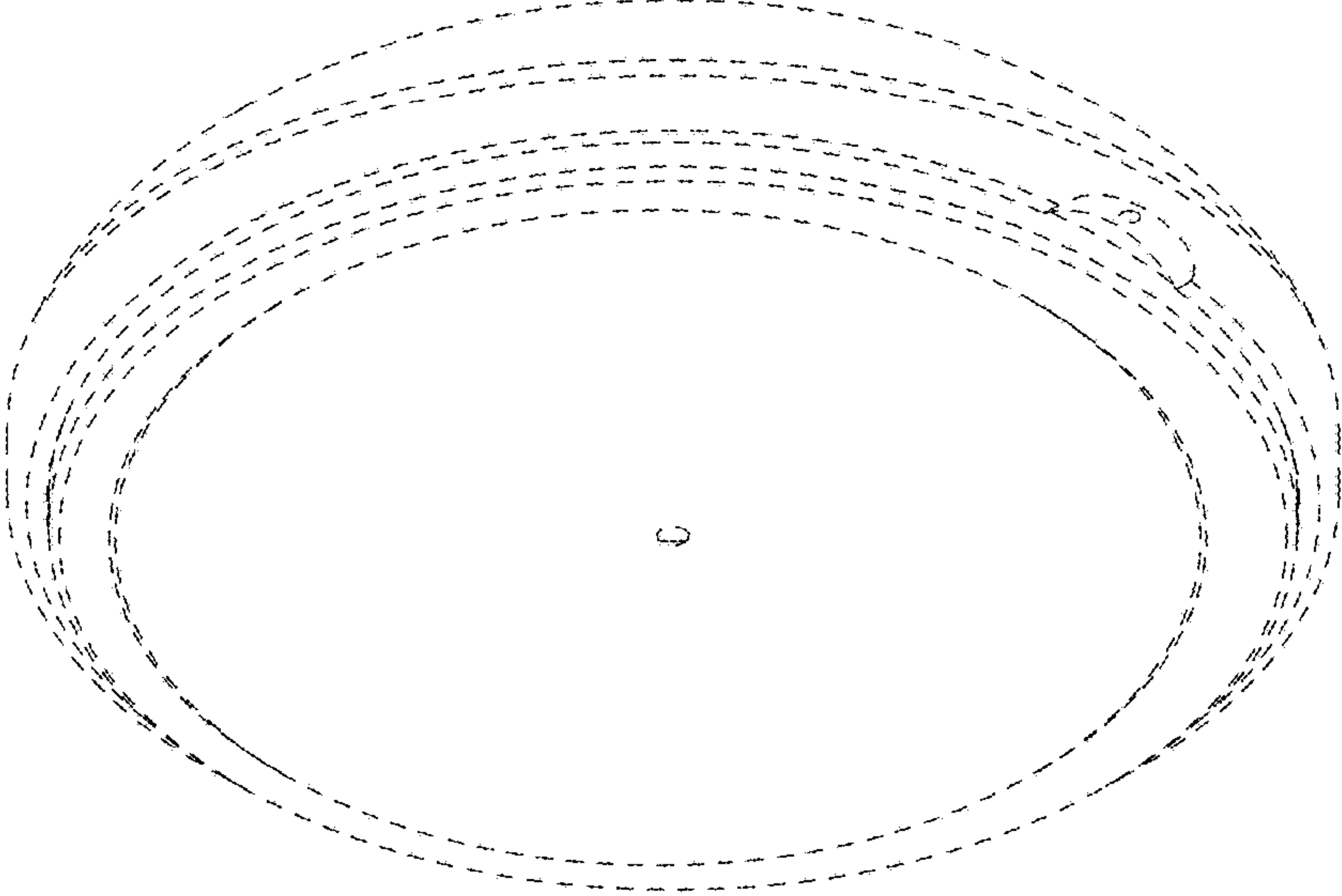

Fig. 2.

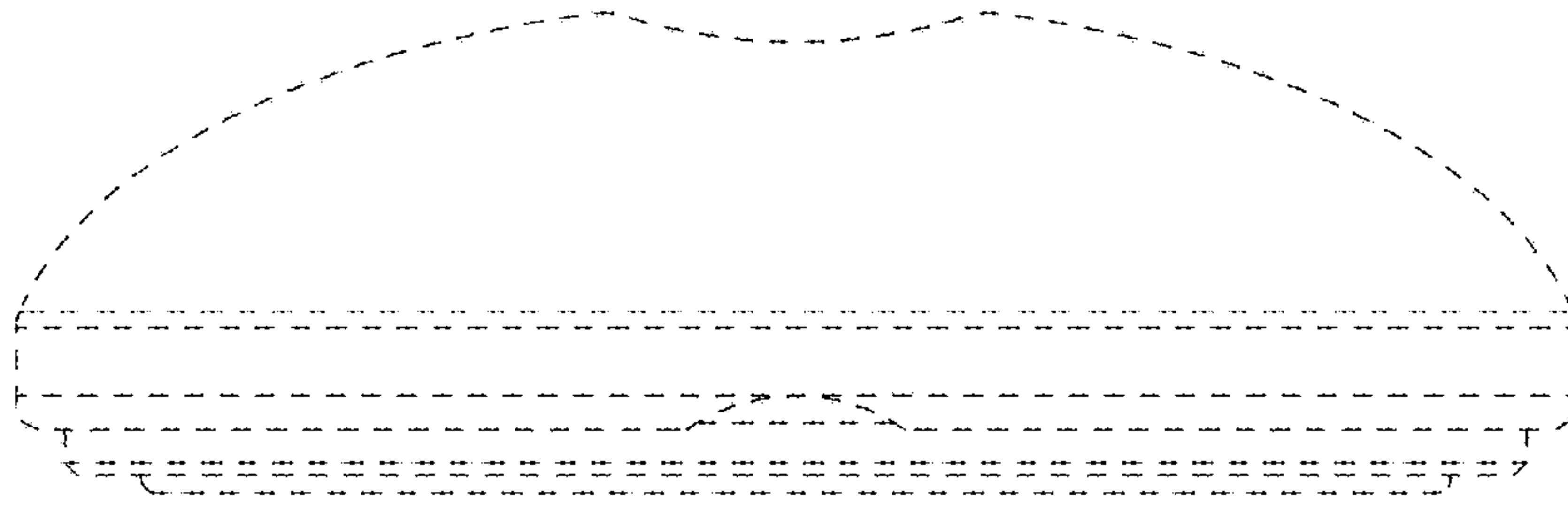

Fig. 3.

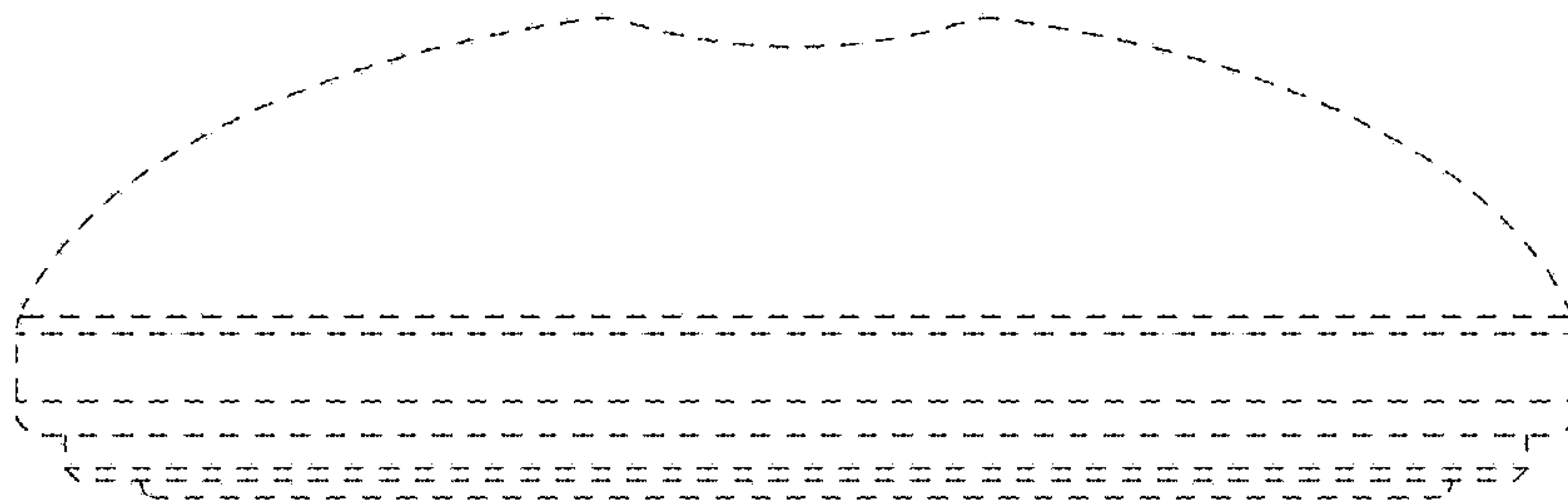

Fig. 4.

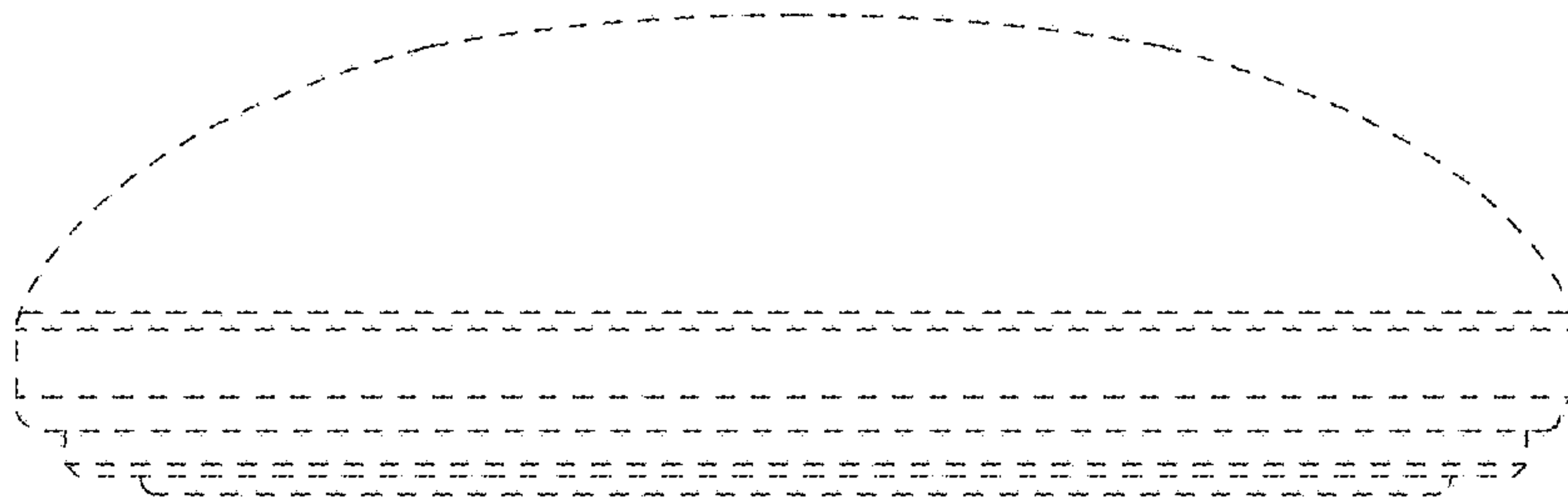

Fig. 5.

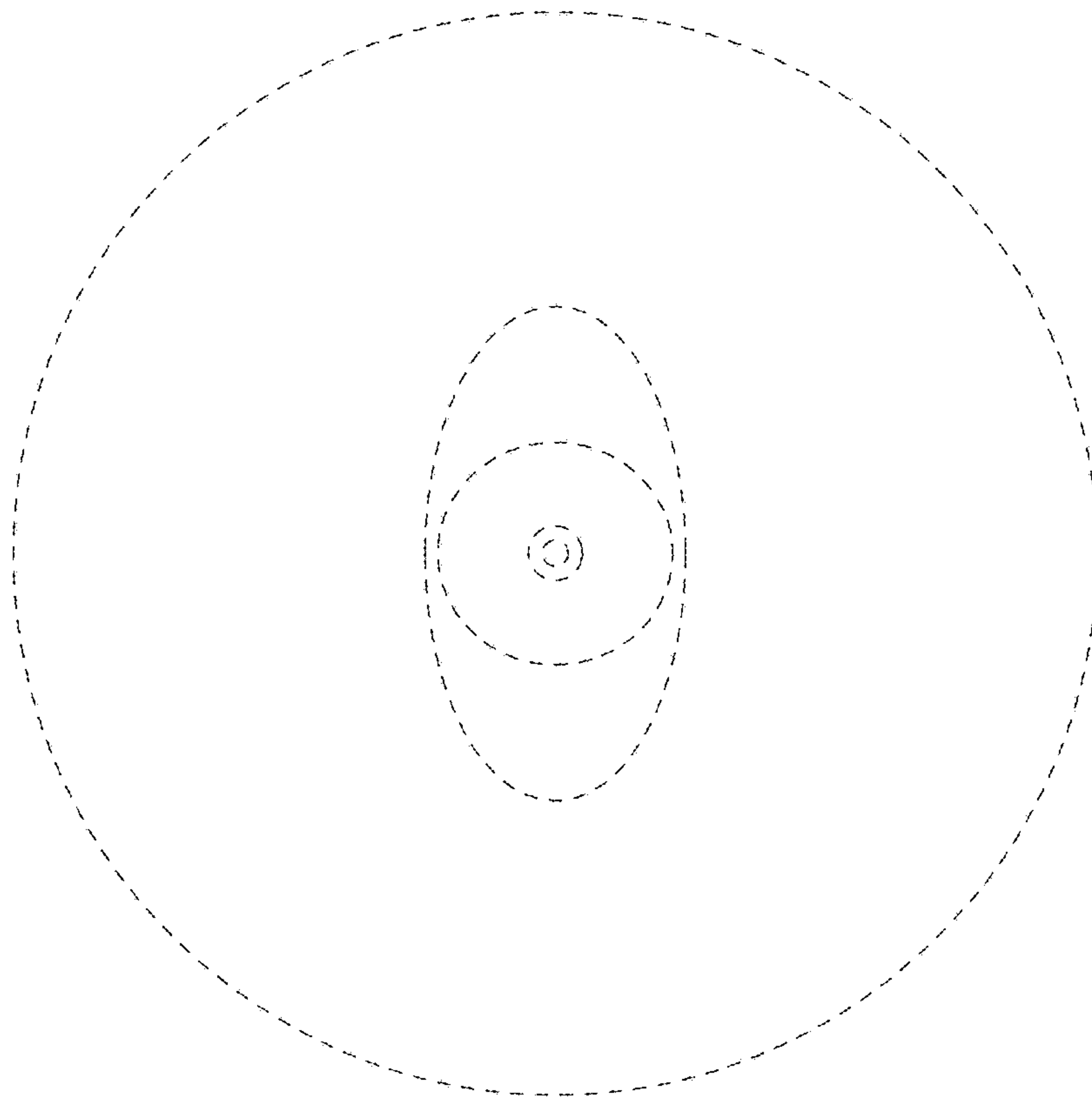

Fig. 6.

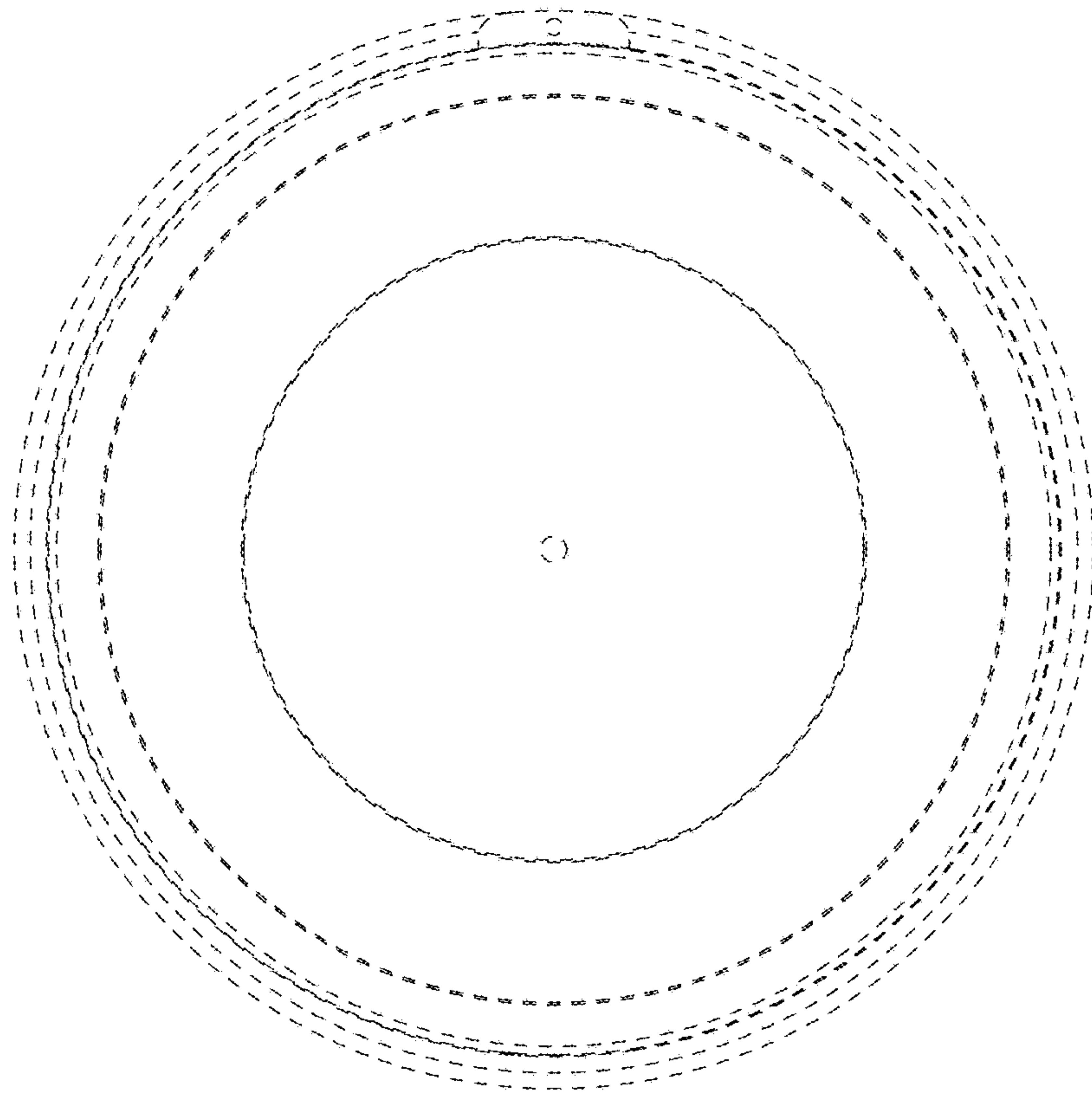

Fig. 7.

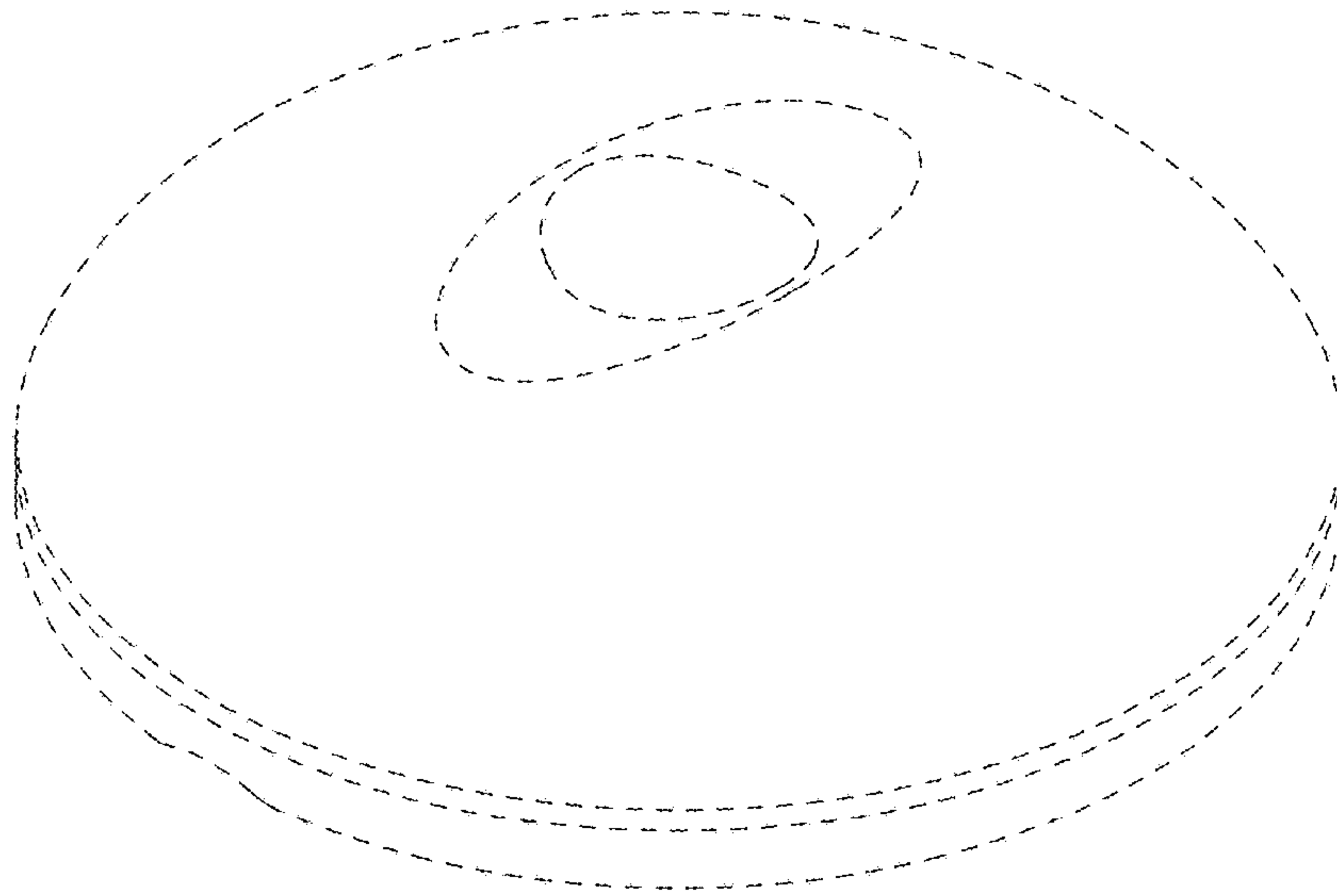

Fig. 8.

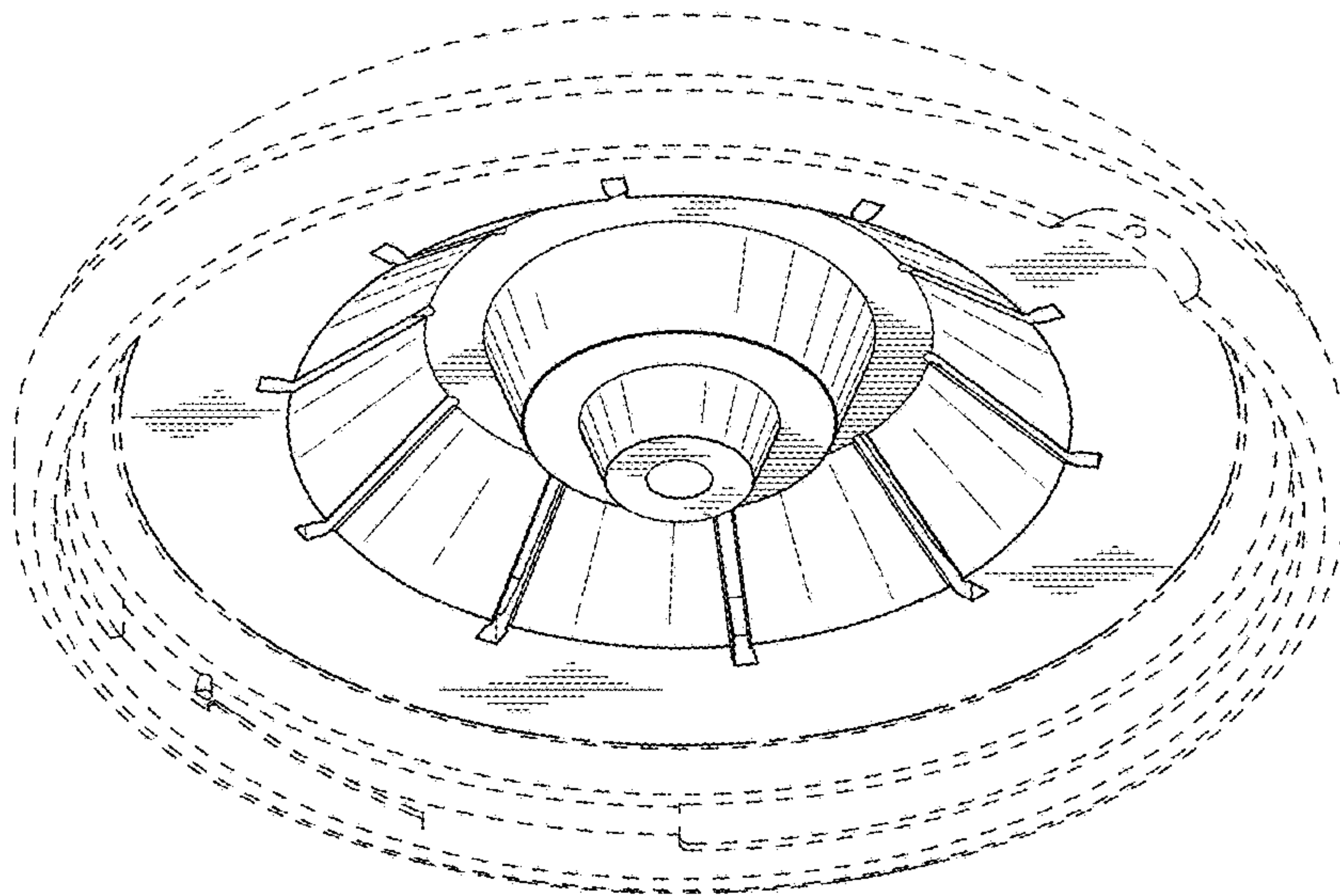

Fig. 9.

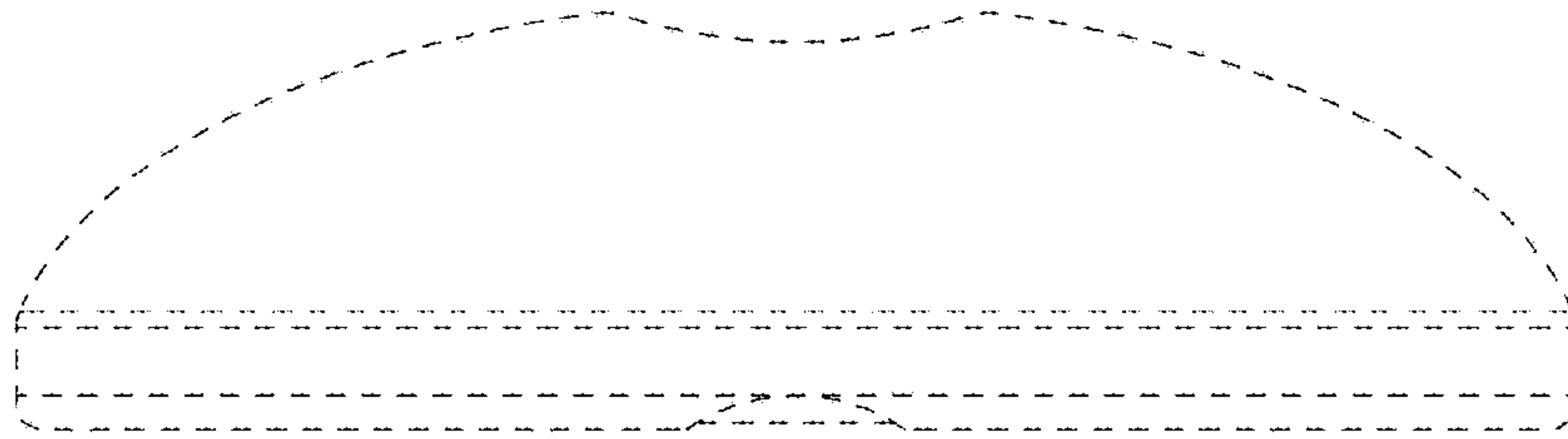

Fig. 10.

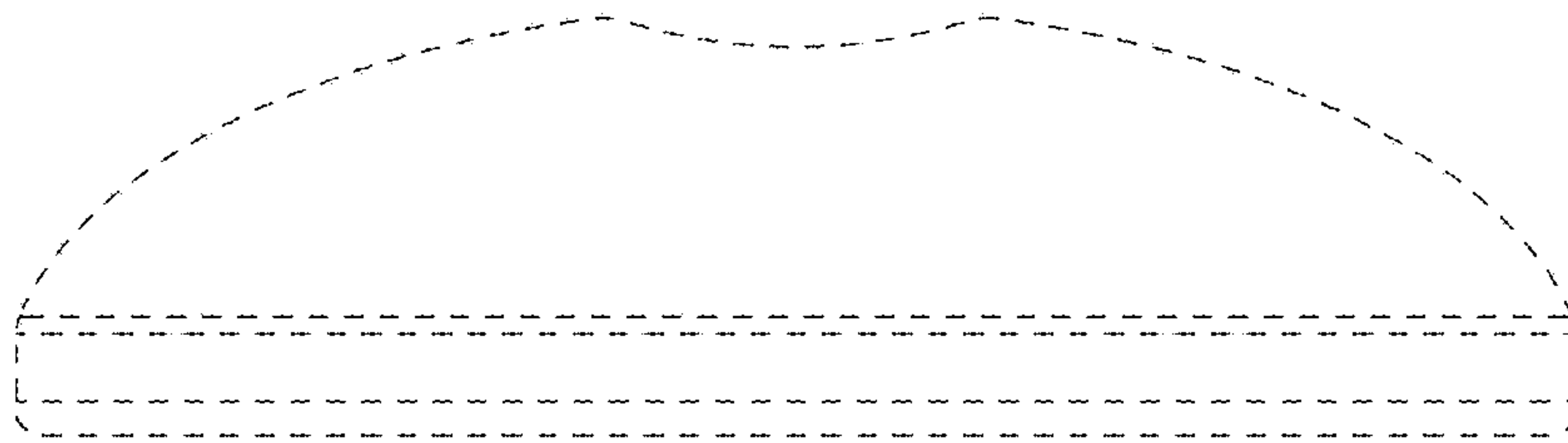

Fig. 11.

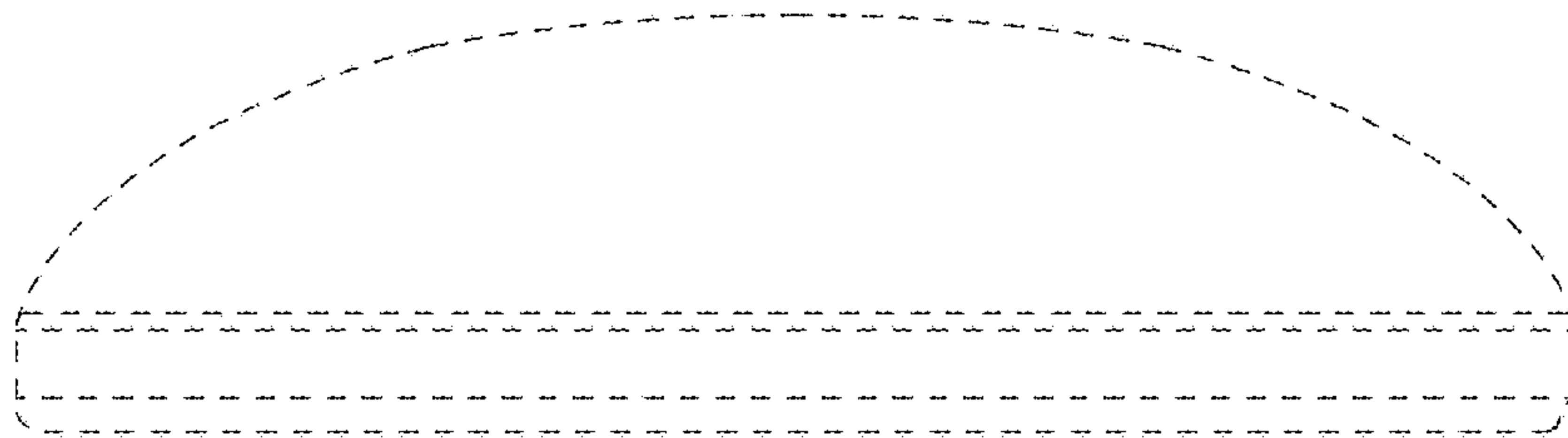

Fig. 12.

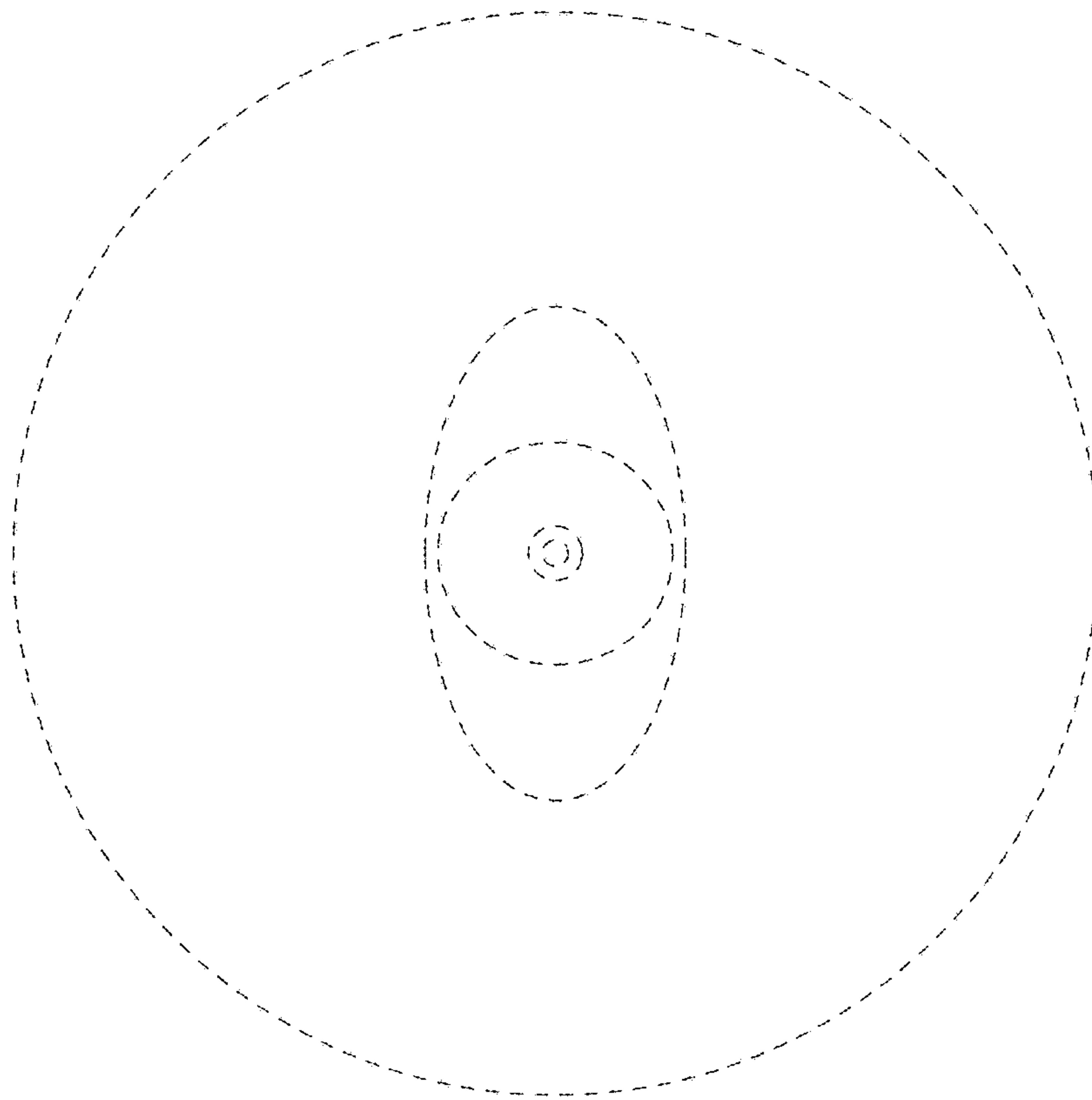

Fig. 13.

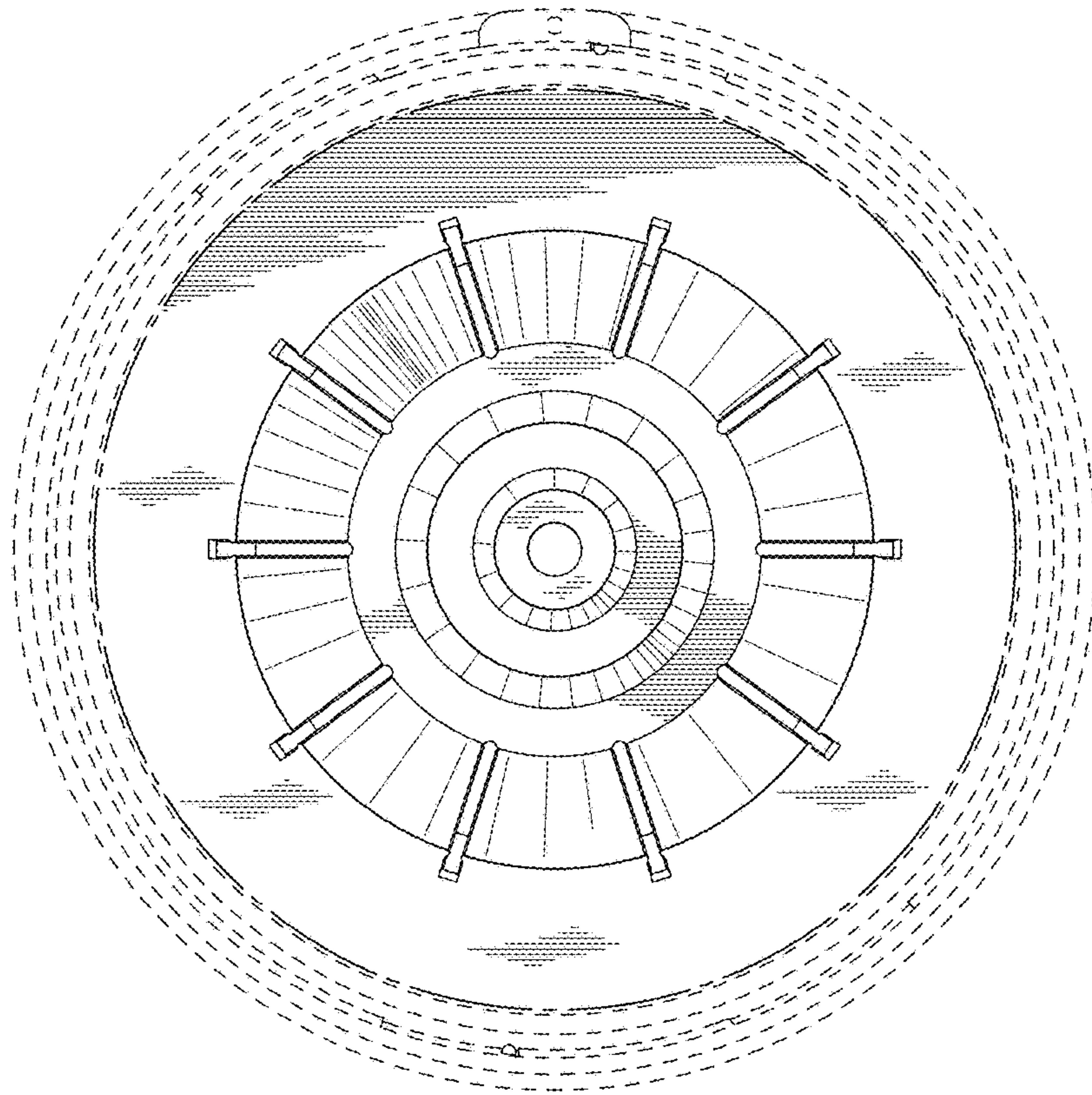

Fig. 14.

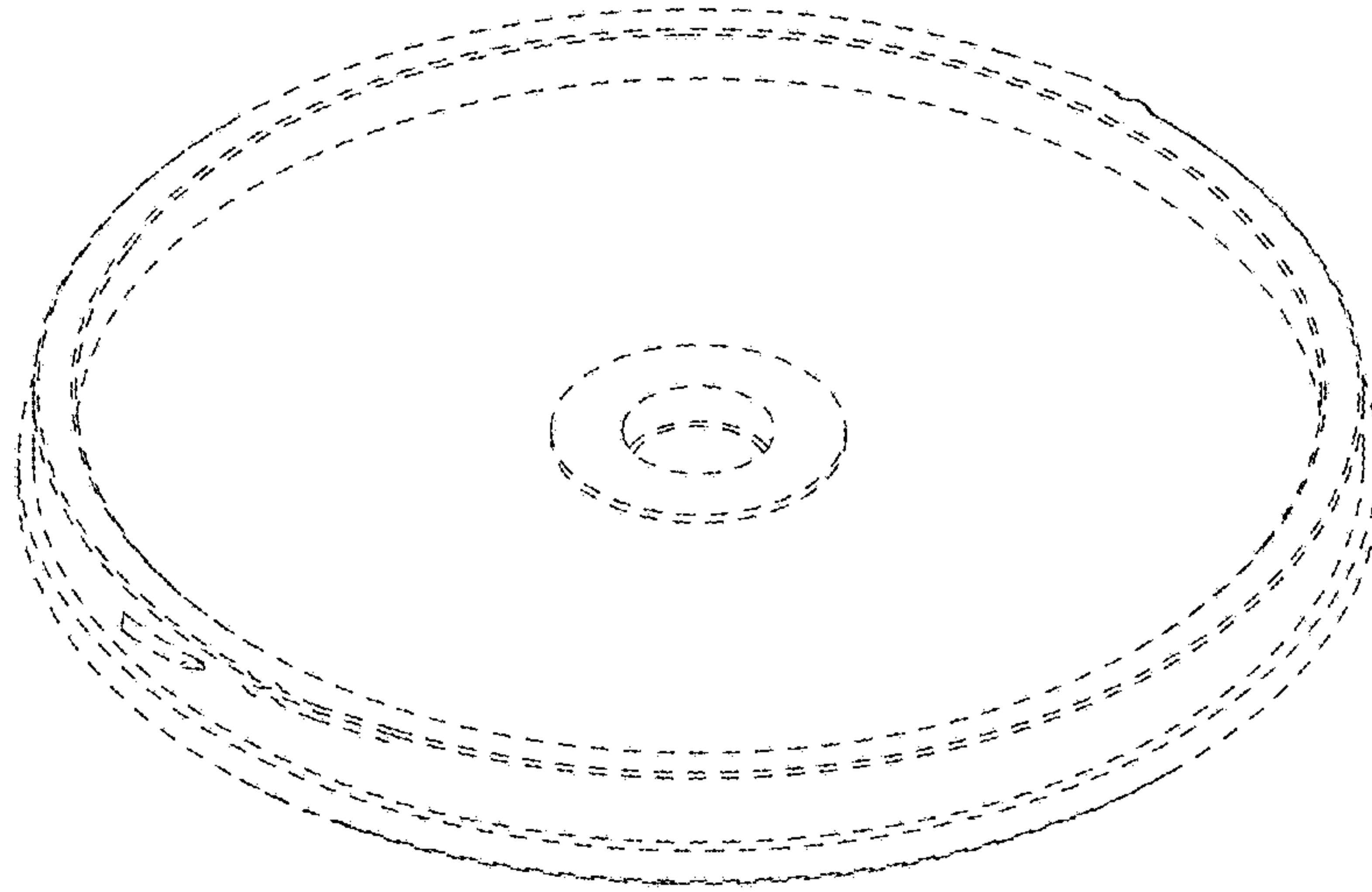

Fig. 15.



Fig. 16.

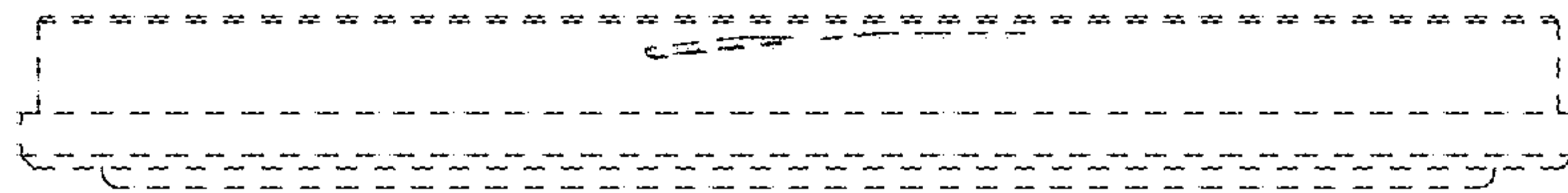

Fig. 17.

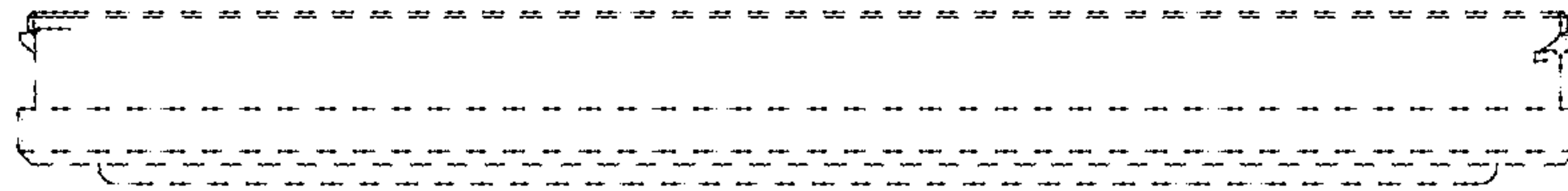

Fig. 18.



Fig. 19.

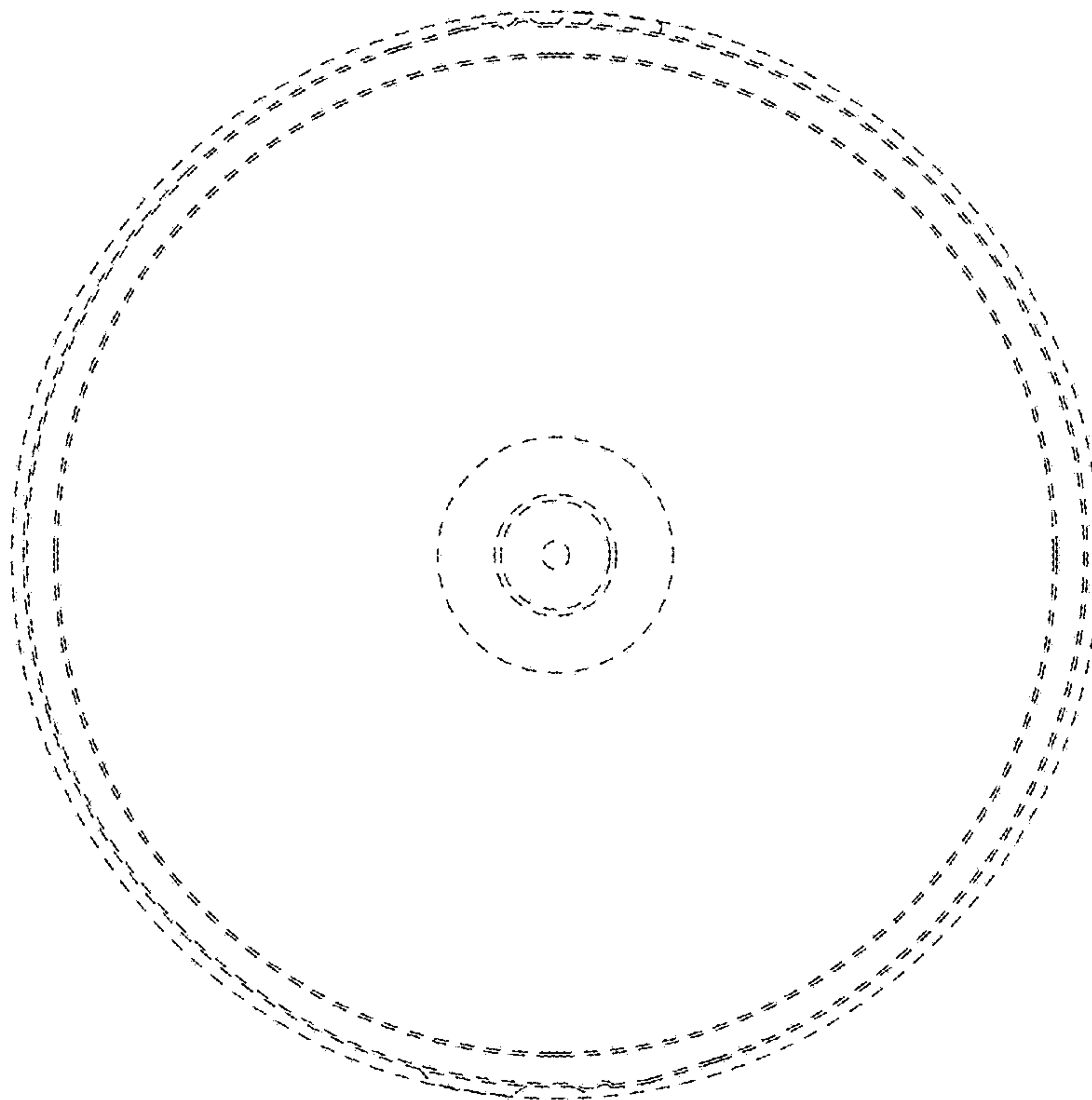

Fig. 20.

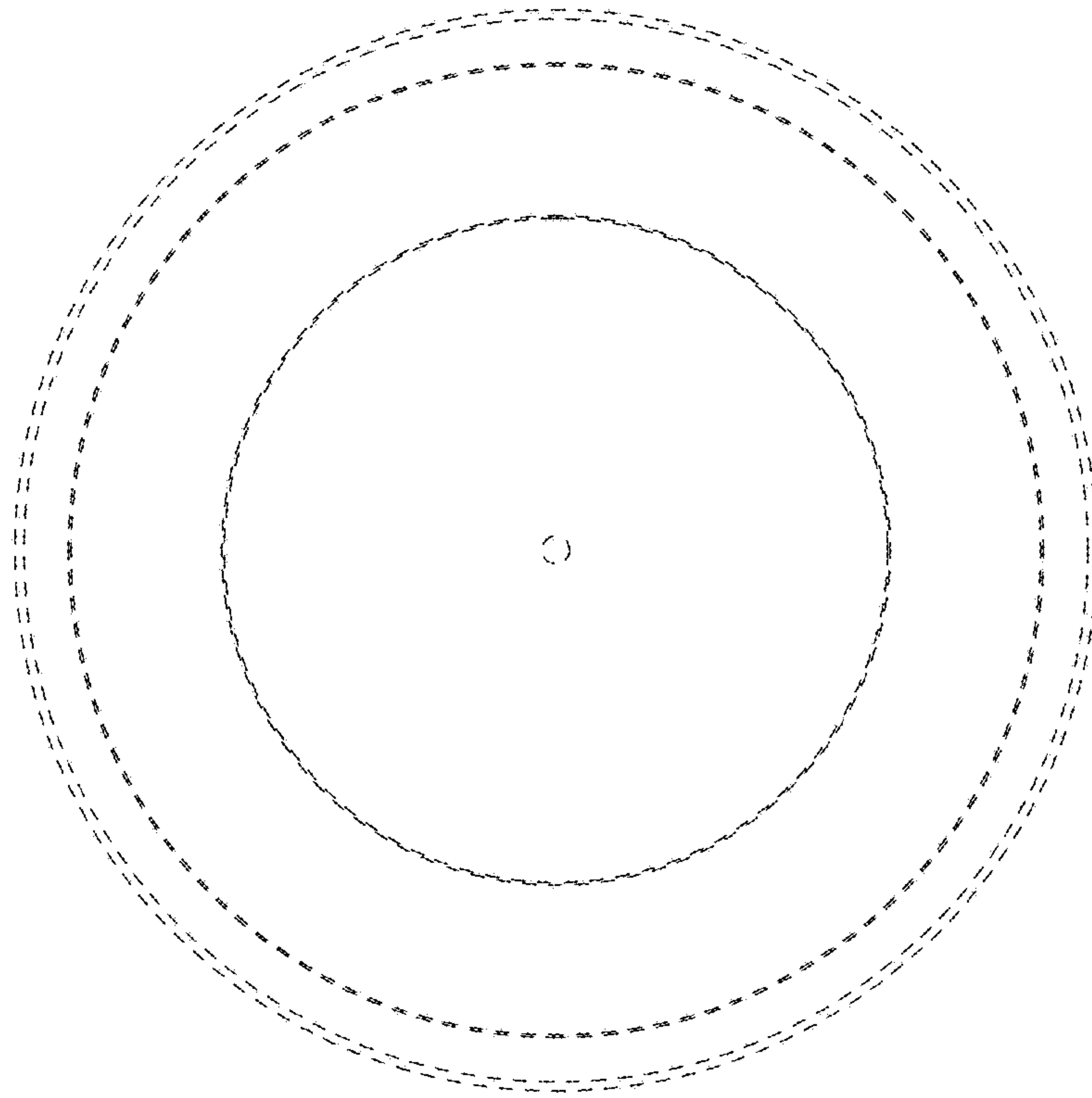

Fig. 21.

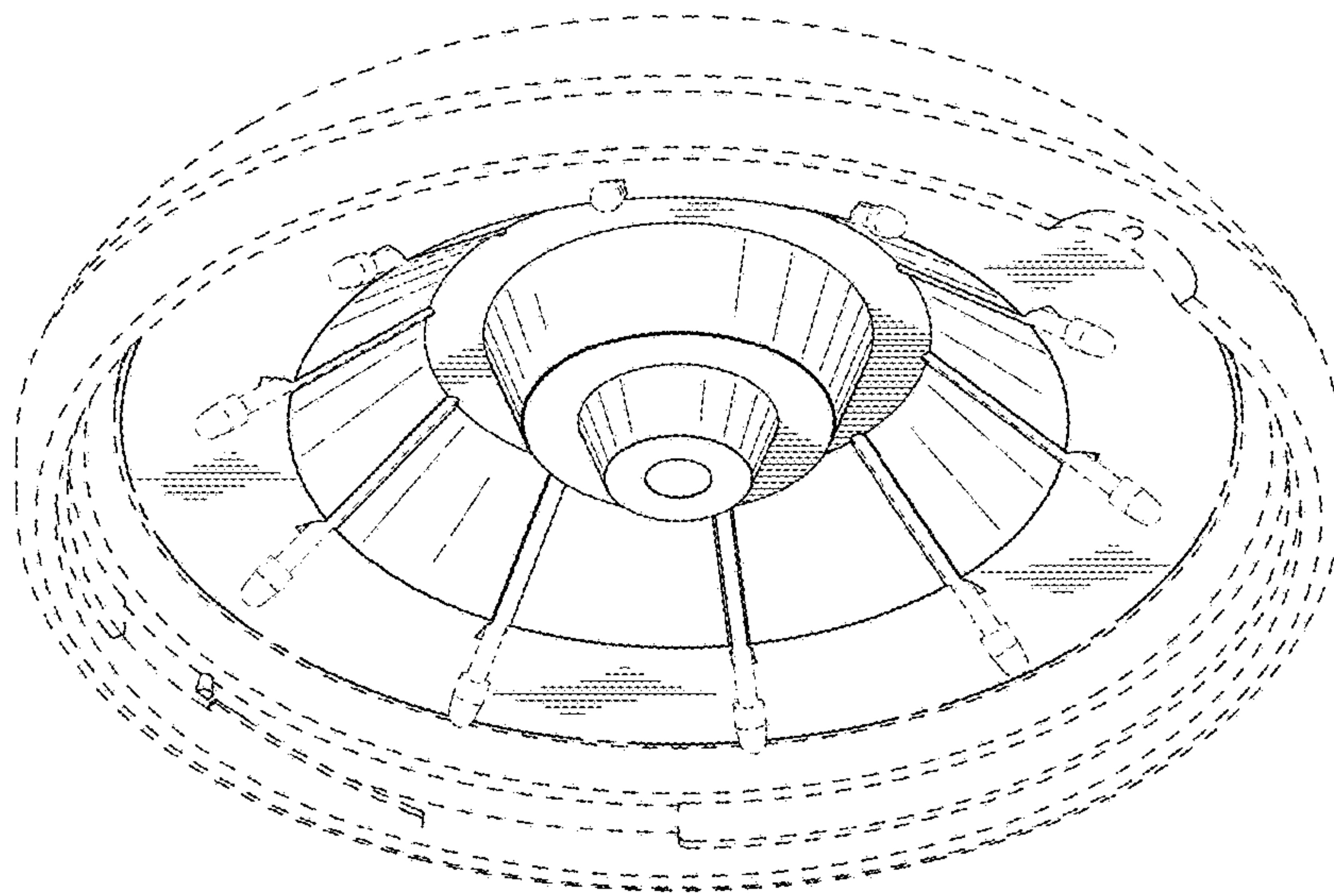

Fig. 22.