



US00D854081S

(12) **United States Design Patent** (10) **Patent No.:** **US D854,081 S**
Jiao (45) **Date of Patent:** **** Jul. 16, 2019**

(54) **SKYLINE POP-UP CARD**

(71) Applicant: **LovePop, Inc.**, Boston, MA (US)
 (72) Inventor: **Xinzhi Jiao**, Cambridge, MA (US)
 (73) Assignee: **LovePop, Inc.**, Boston, MA (US)
 (**) Term: **15 Years**

(21) Appl. No.: **29/592,811**
 (22) Filed: **Feb. 2, 2017**
 (51) **LOC (11) Cl.** **19-01**
 (52) **U.S. Cl.**
 USPC **D19/1**
 (58) **Field of Classification Search**

USPC D19/1-8, 100; 40/124.01-124.15, 582,
 40/540, 443, 442, 902, 617, 599, 331,
 40/360, 717, 124.191; 362/808, 806;
 283/2-4, 74-75, 103, 105-106; D20/10,
 D20/22, 27, 40; 229/92.8, 116.1, 116.3,
 229/116.5, 116.4; 428/8-9, 16, 20
 CPC B42D 25/00; B42D 25/20; B42D 25/23;
 B42D 25/26; B42D 25/29; B42D 25/30;
 B42D 25/285; B42D 15/00; B42D
 15/022; B42D 15/027; B42D 15/045;
 B42D 15/042; B42D 2033/02; B42D
 2033/04; B42D 2033/08; B42D 2033/10;
 B42D 2033/16; B42D 2033/18; B42D
 2033/20; B42D 2033/22; B42D 2033/28;
 B42D 2033/30; G09F 1/00; G09F 1/02;
 G09F 1/08

See application file for complete search history.

(56) **References Cited**

U.S. PATENT DOCUMENTS

D662,543 S * 6/2012 Dennis D19/1
 9,434,202 B2 * 9/2016 Mayer B42D 15/02
 9,475,333 B2 * 10/2016 Yeh G09F 1/08
 D815,201 S * 4/2018 Larson D19/1
 2017/0148358 A1 * 5/2017 Wise G09F 1/06

* cited by examiner

Primary Examiner — Abraham Bahta

(74) *Attorney, Agent, or Firm* — Foley Hoag LLP; Rajesh Vallabh

(57) **CLAIM**

The ornamental design for a skyline pop-up card, as shown and described.

DESCRIPTION

FIG. 1 is a perspective view of a skyline pop-up card showing my new design;
 FIG. 2 is an enlarged view of the portion of the skyline pop-up card depicted in the detail circle of FIG. 1;
 FIG. 3 is a top view thereof;
 FIG. 4 is a front view thereof;
 FIG. 5 is a right side view thereof;
 FIG. 6 is a left side view thereof;
 FIG. 7 is a rear view thereof; and,
 FIG. 8 is a bottom view thereof.
 The broken lines in the figures depict environmental subject matter only and form no part of the claimed design. The dot-dashed lines in the figures show borders of the subject matter being claimed. The dot-dashed lines form no part of the claimed design.

1 Claim, 7 Drawing Sheets

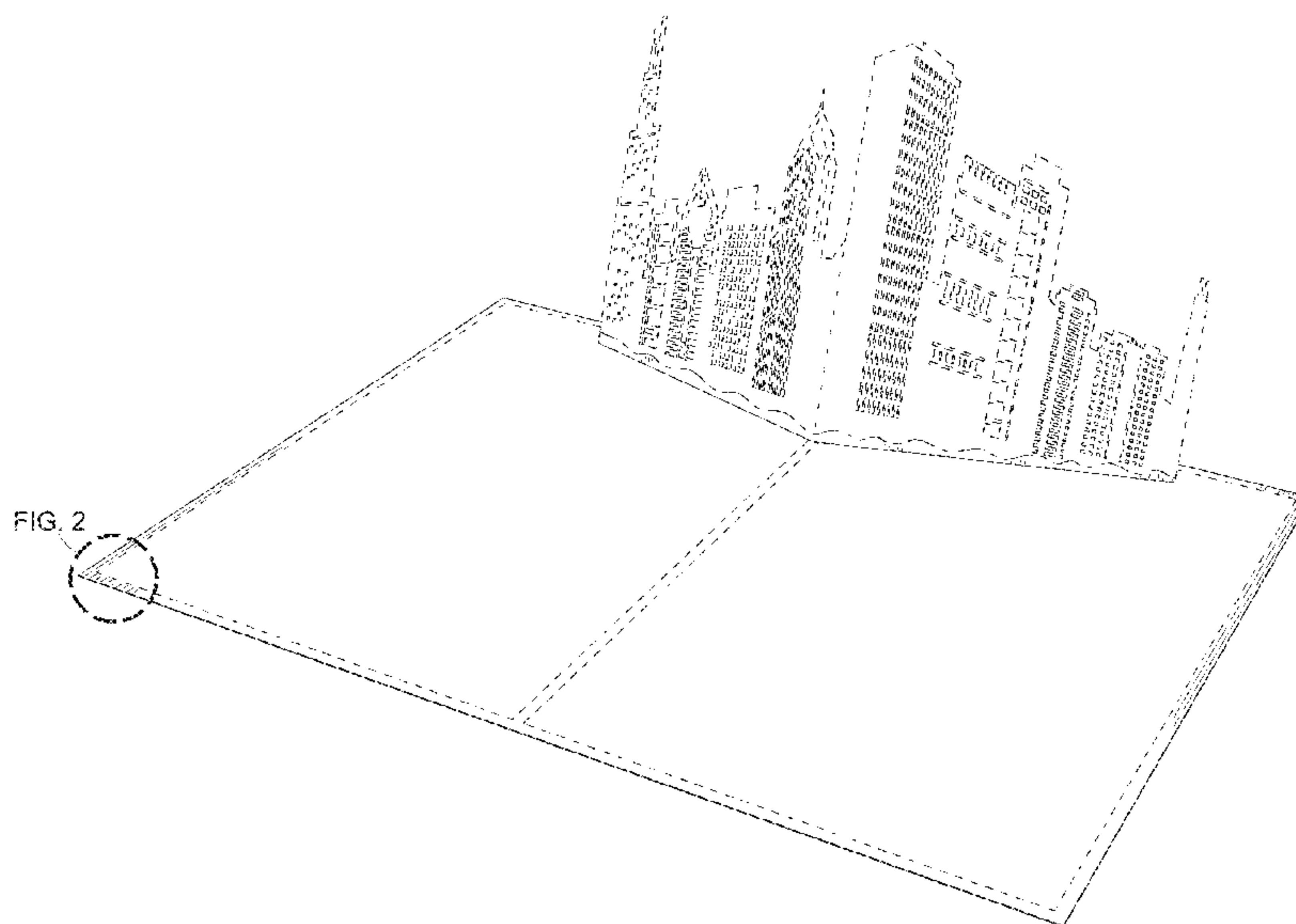

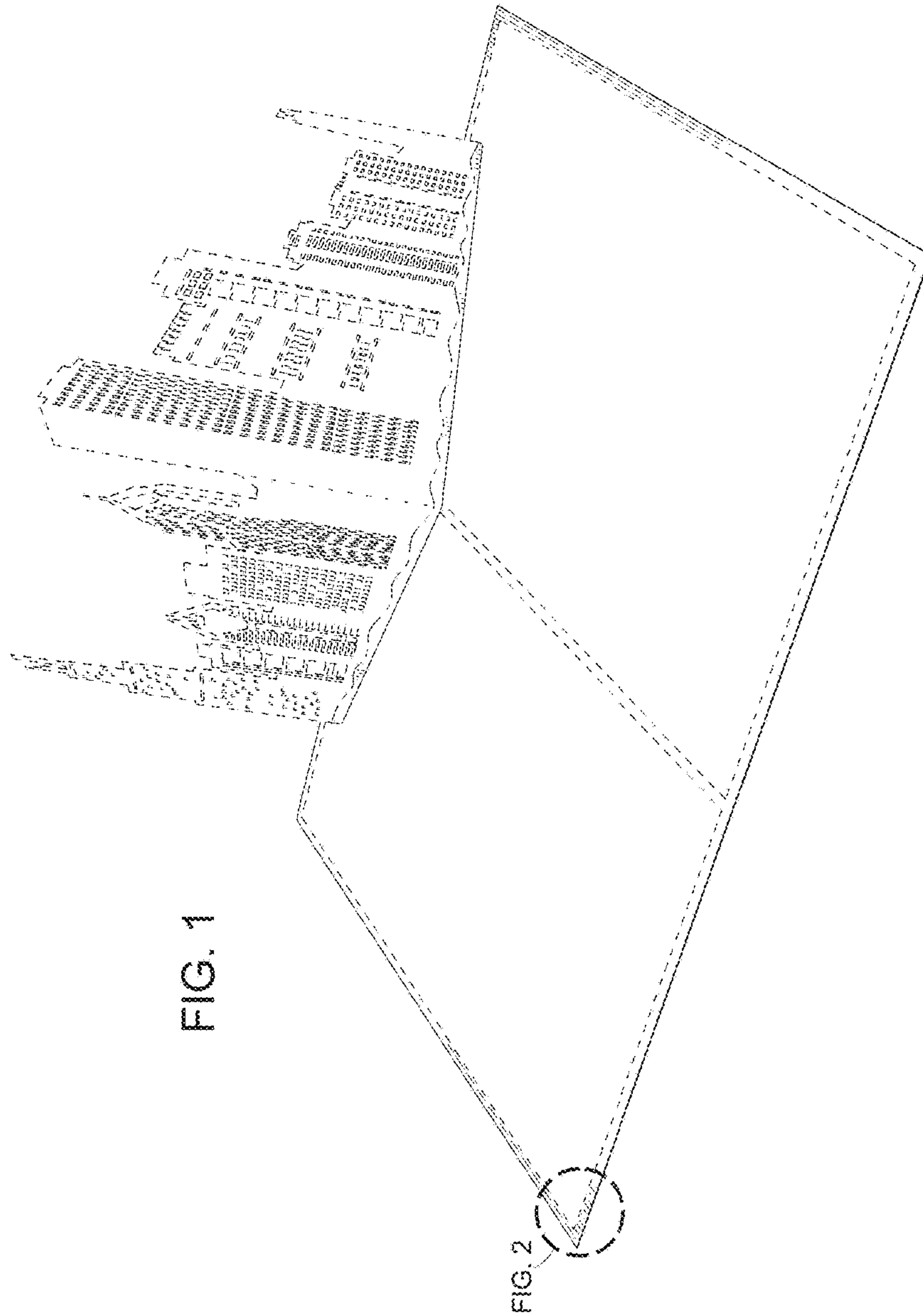

FIG. 1

FIG. 2

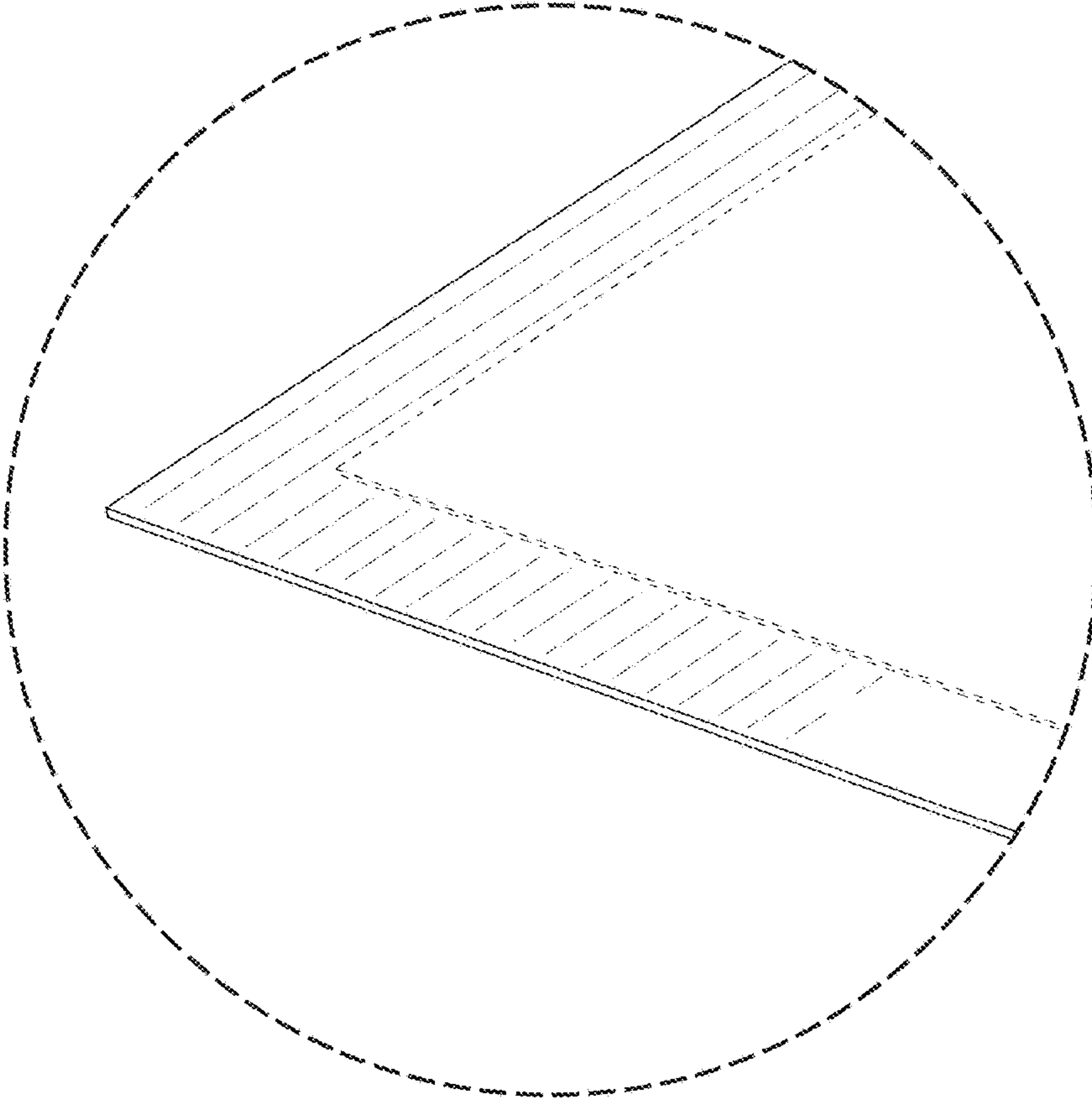

FIG. 2

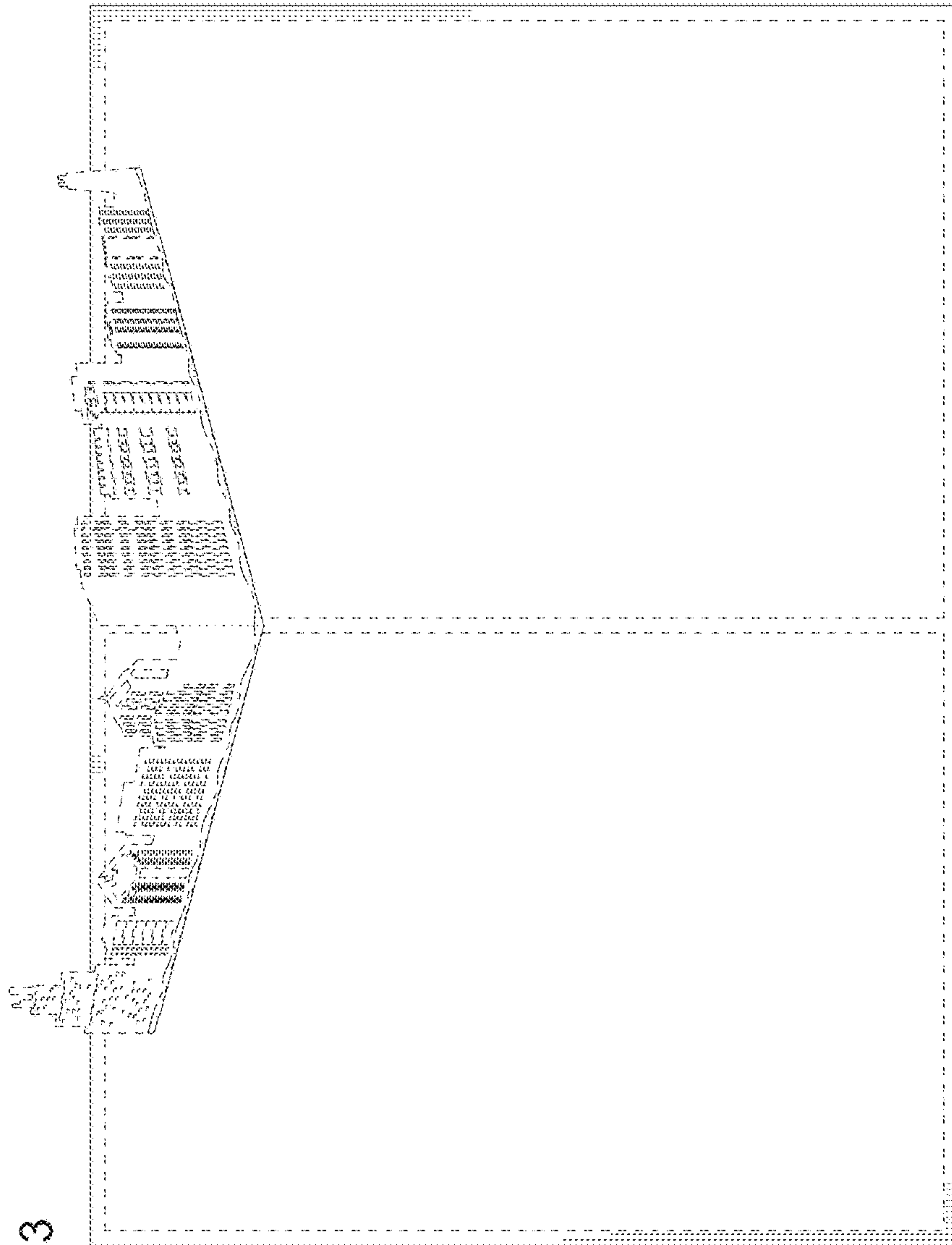

FIG. 3

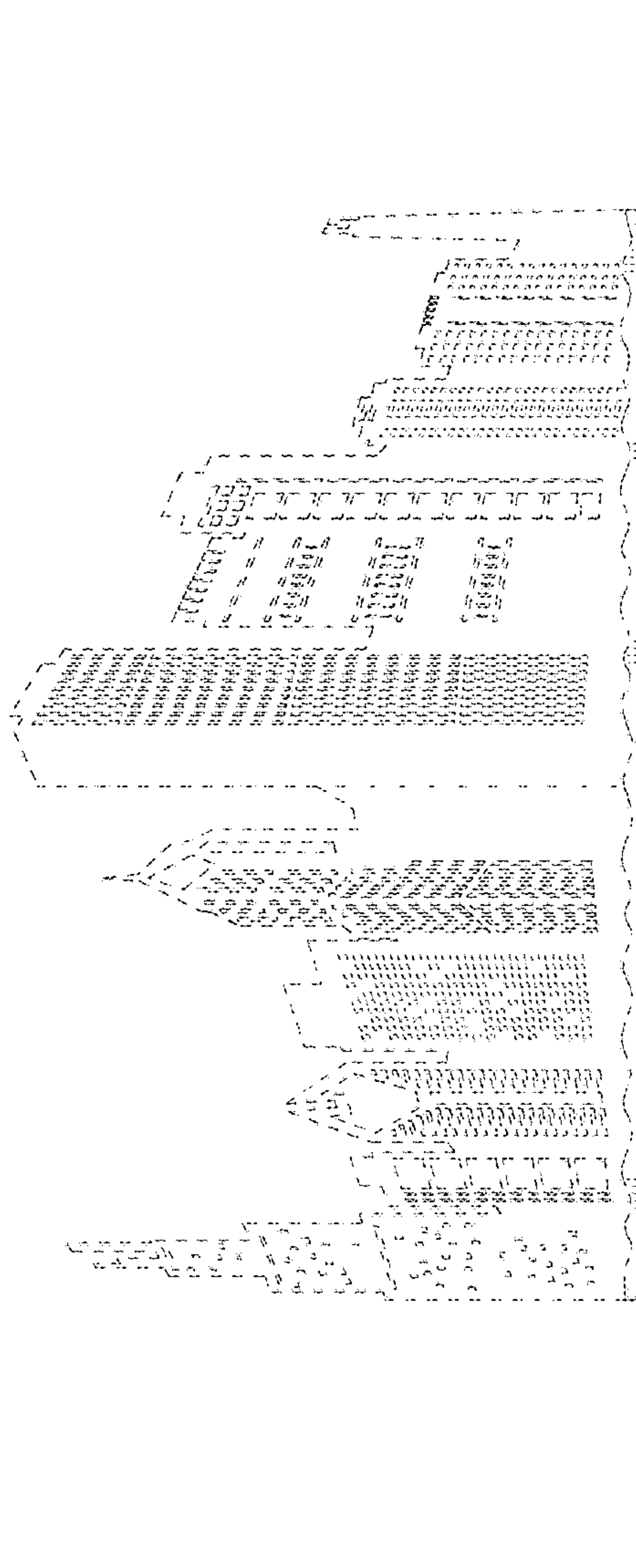

FIG. 4

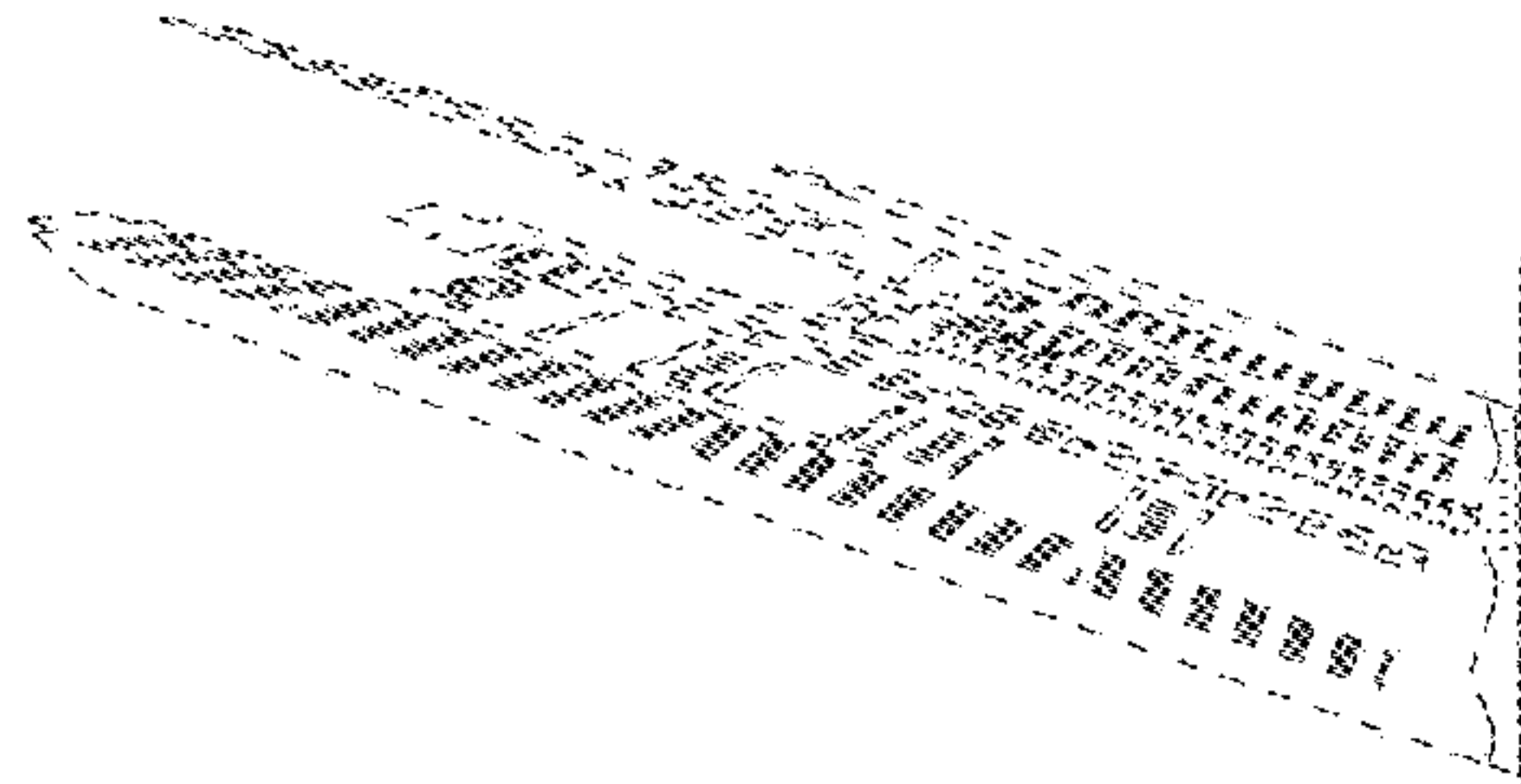

FIG. 5

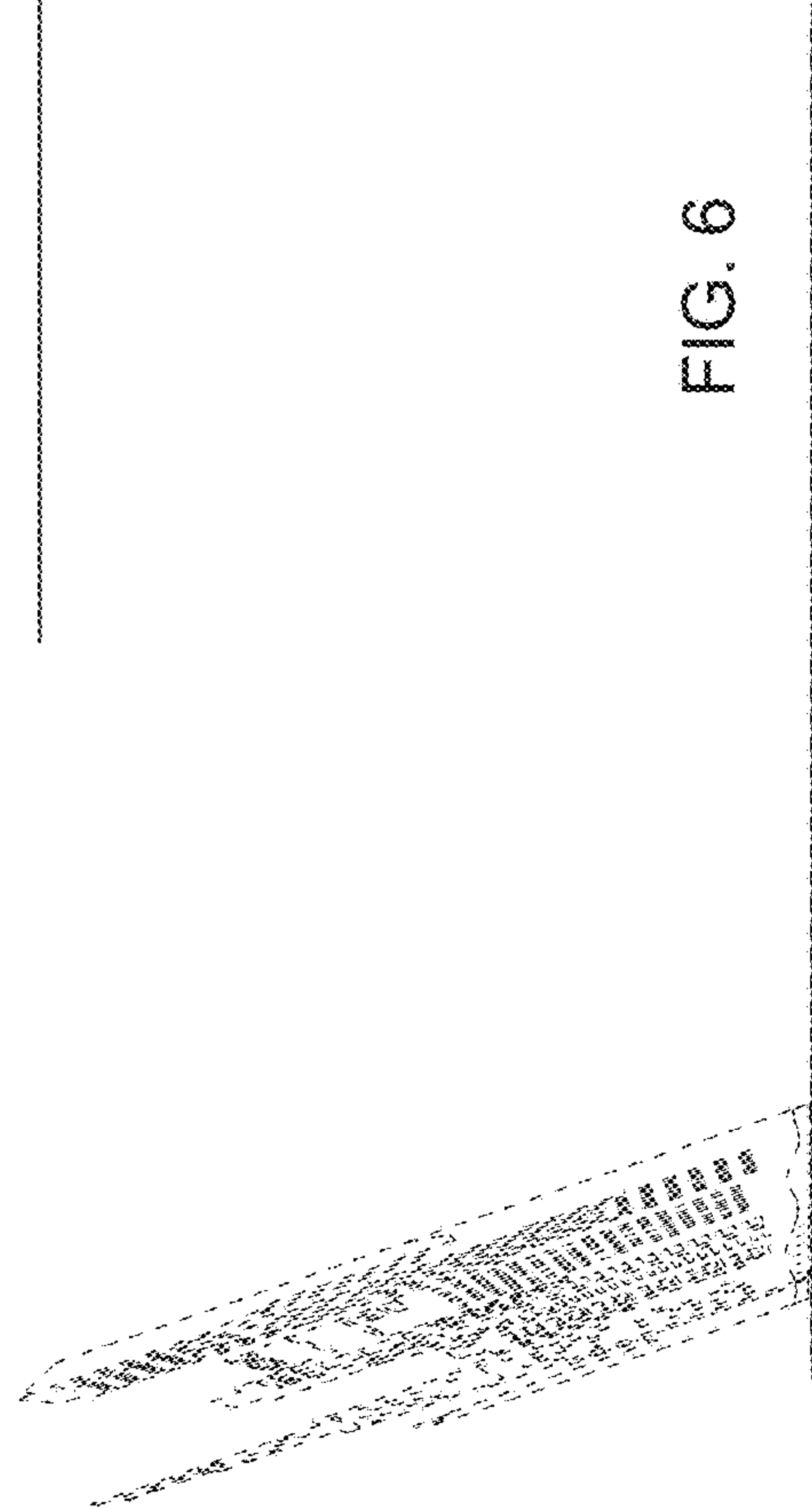

FIG. 6

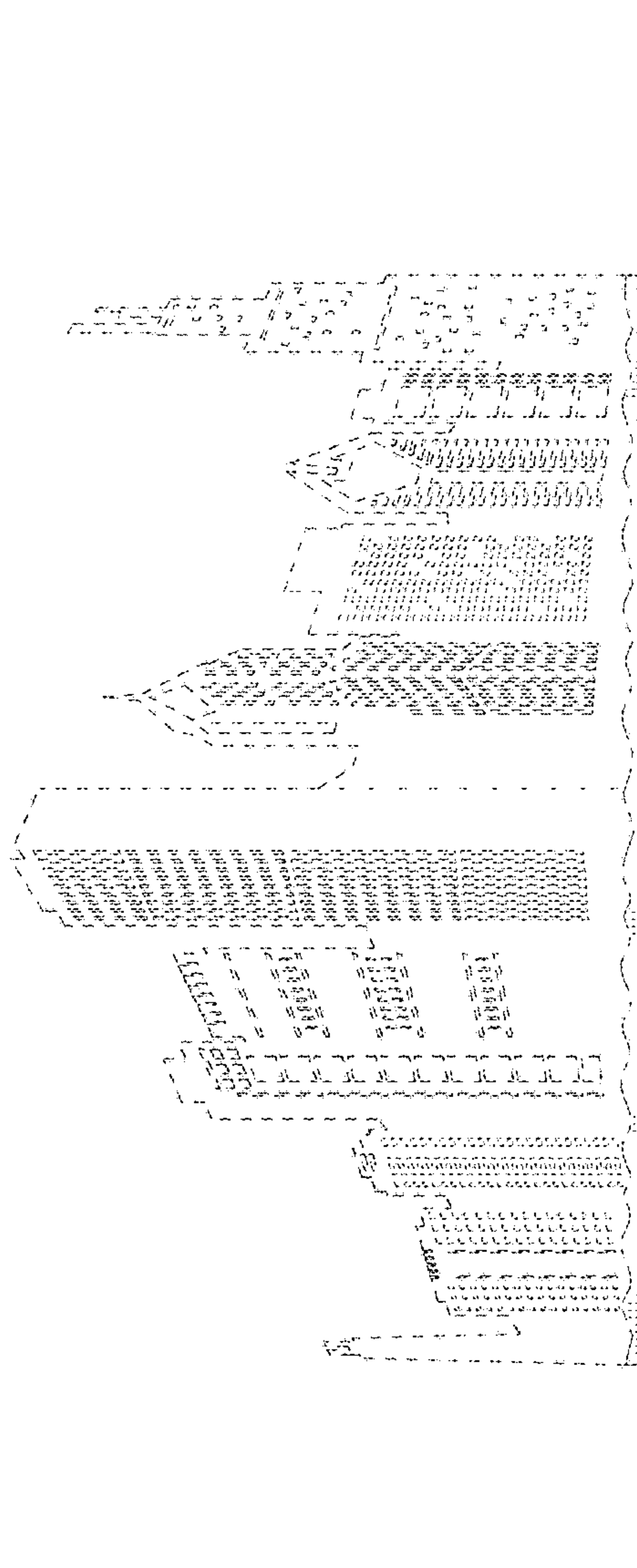

FIG. 7

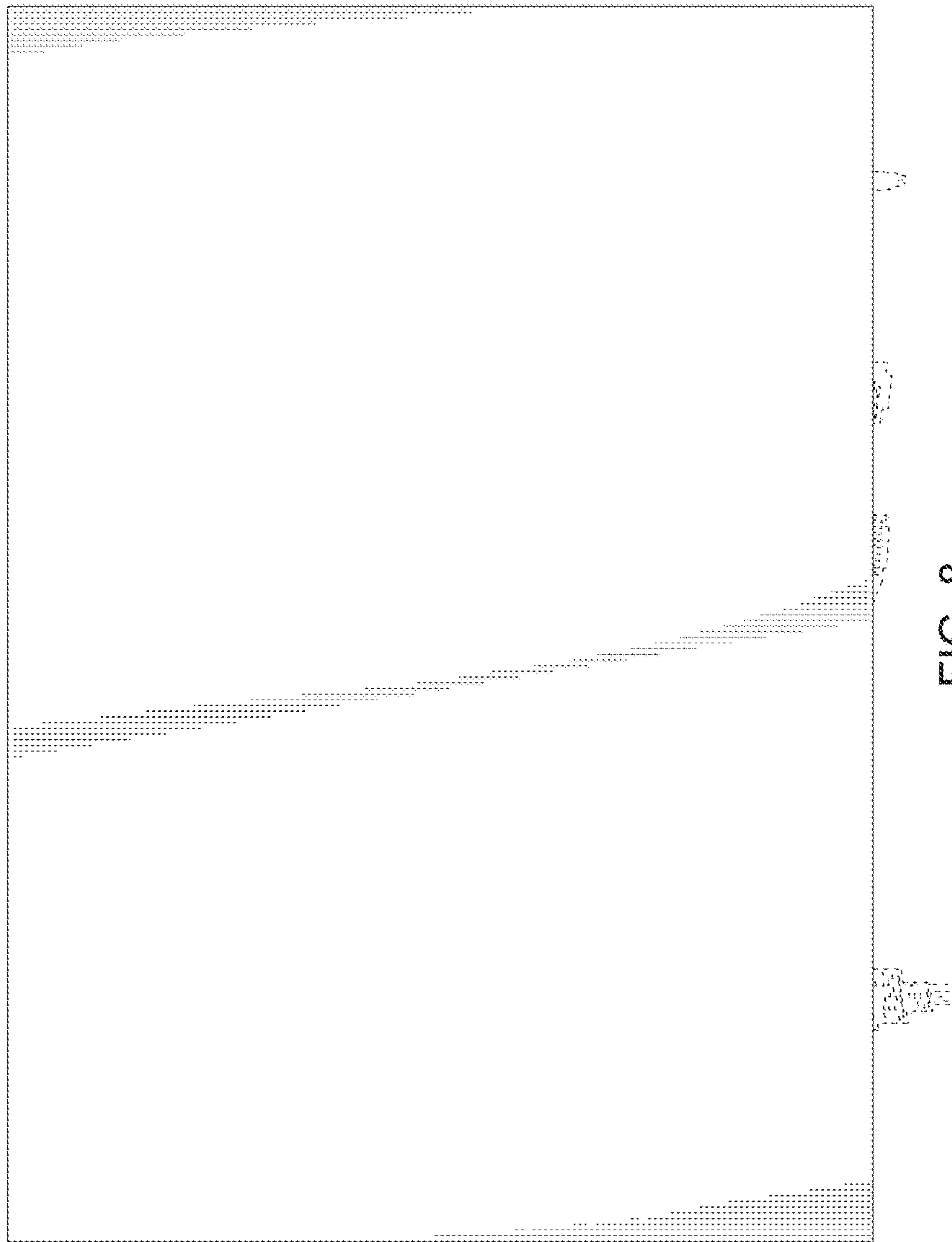

FIG. 8