



US00D854024S

(12) **United States Design Patent** (10) **Patent No.:** **US D854,024 S**  
**Fenton et al.** (45) **Date of Patent:** **\*\* Jul. 16, 2019**

(54) **KEYBOARD CASE**  
(71) Applicant: **Fairhaven Group, Inc.**, Seattle, WA (US)  
(72) Inventors: **Timothy John Fenton**, Mercer Island, WA (US); **Gary Allen Ashley**, Seattle, WA (US)  
(73) Assignee: **PIONEER SQUARE BRANDS, INC.**, McLean, VA (US)

D730,915 S \* 6/2015 Lee ..... D14/455  
9,348,366 B2 \* 5/2016 Fathollahi ..... G06F 1/1628  
D779,494 S \* 2/2017 Hallier ..... D14/252  
D781,282 S \* 3/2017 Hsu ..... D14/315  
9,715,254 B2 \* 7/2017 Mori ..... G06F 1/1662  
D795,879 S \* 8/2017 Hunter ..... D14/440  
D795,881 S \* 8/2017 Akana ..... D14/440  
D807,363 S \* 1/2018 Hallier ..... D14/440  
D807,365 S \* 1/2018 Liu ..... D14/440  
D807,892 S \* 1/2018 Wang ..... D14/440  
2004/0066613 A1 \* 4/2004 Leitao ..... G06F 1/1607  
361/679.02

(\*\*) Term: **15 Years**

\* cited by examiner

(21) Appl. No.: **29/553,453**

*Primary Examiner* — Lakiya G Rogers

(22) Filed: **Feb. 1, 2016**

*Assistant Examiner* — Harold E Blackwell, II

(51) **LOC (11) Cl.** ..... **14-02**

(74) *Attorney, Agent, or Firm* — Grandview Law

(52) **U.S. Cl.**  
USPC ..... **D14/455**

(57) **CLAIM**

The ornamental design for a keyboard case, as shown and described.

(58) **Field of Classification Search**  
USPC ..... D14/240, 315, 391-399, 443, 455, 456, D14/433; 206/45.23, 320, 45.2; 361/679.08, 679.09, 679.55, 679.59, 361/679.17, 679.44, 679.41, 679.01, 361/679.26; 200/5 A, 5 R, 6 A, 6 R  
See application file for complete search history.

**DESCRIPTION**

FIG. 1 is a front perspective view thereof.  
FIG. 2 is a rear perspective view thereof.  
FIG. 3 is a left elevational view thereof.  
FIG. 4 is a top plan view thereof.  
FIG. 5 is a front elevational view thereof.  
FIG. 6 is a bottom plan view thereof; and,  
FIG. 7 is a rear elevational view thereof.  
The features shown in broken lines in the drawing figures depict features that form no part of the claimed design.

(56) **References Cited**  
U.S. PATENT DOCUMENTS

D674,399 S \* 1/2013 Welch ..... D14/455  
D675,625 S \* 2/2013 Hasbrook ..... D14/440

**1 Claim, 4 Drawing Sheets**

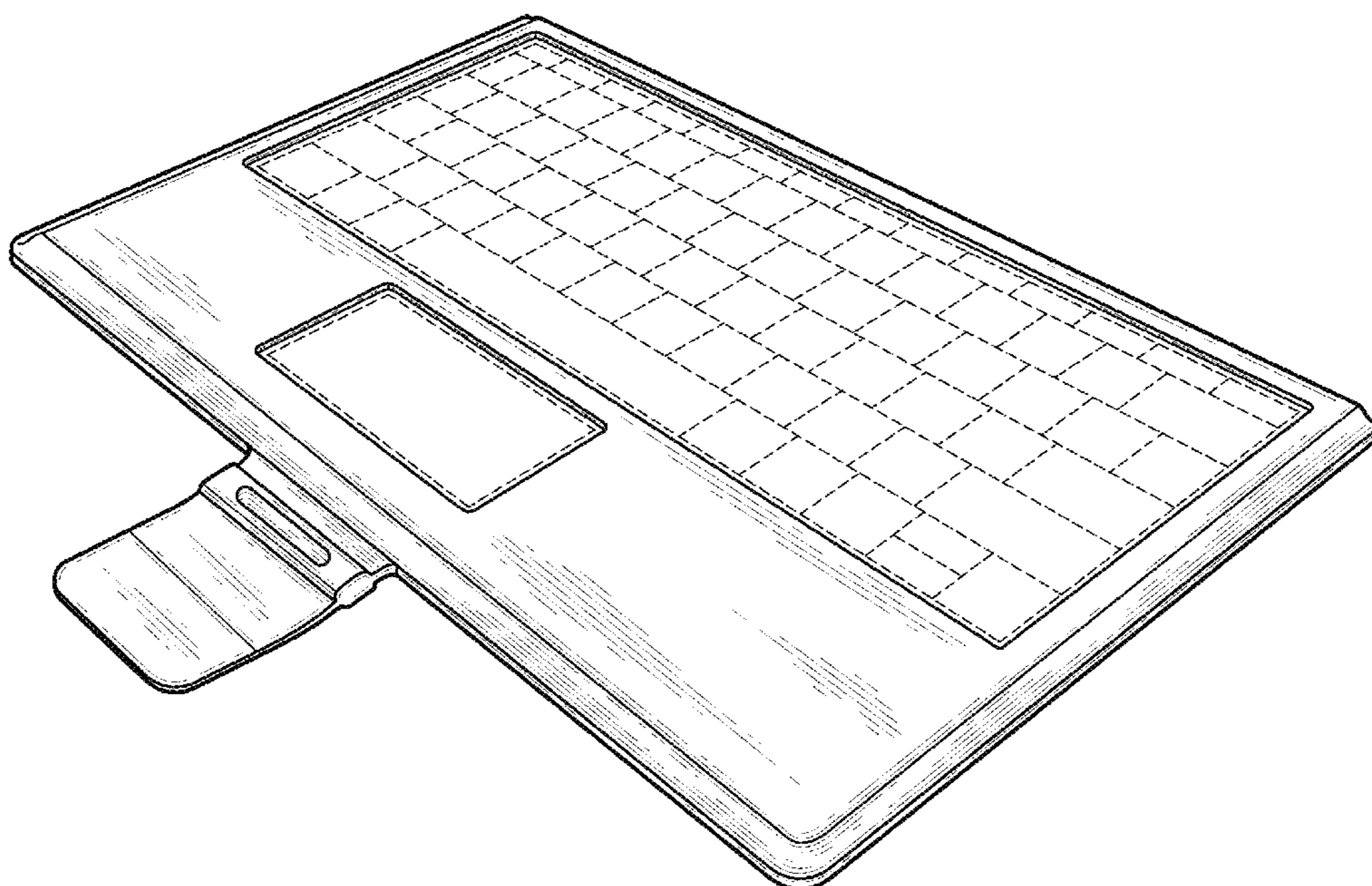

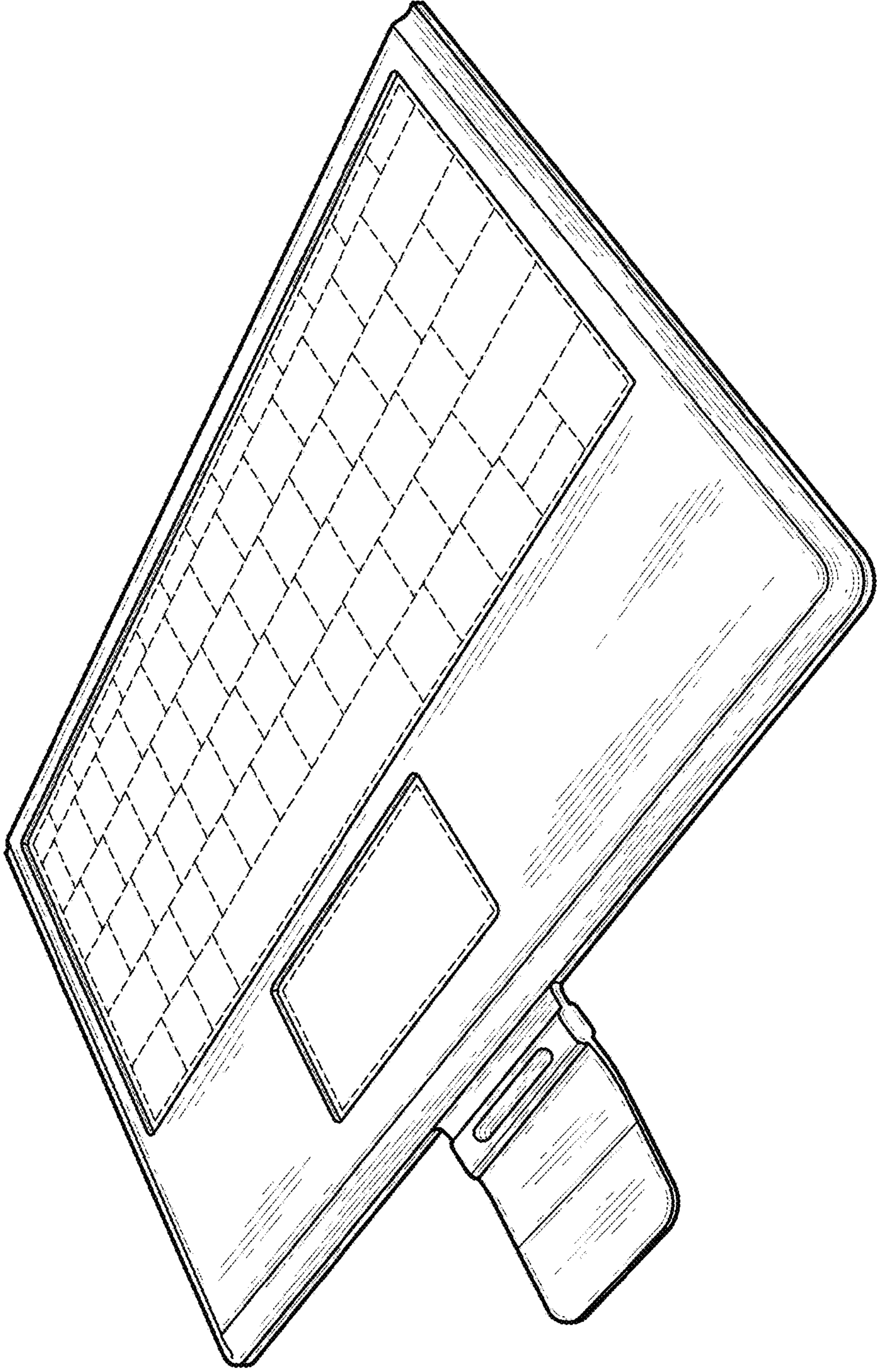

*Fig. 1*



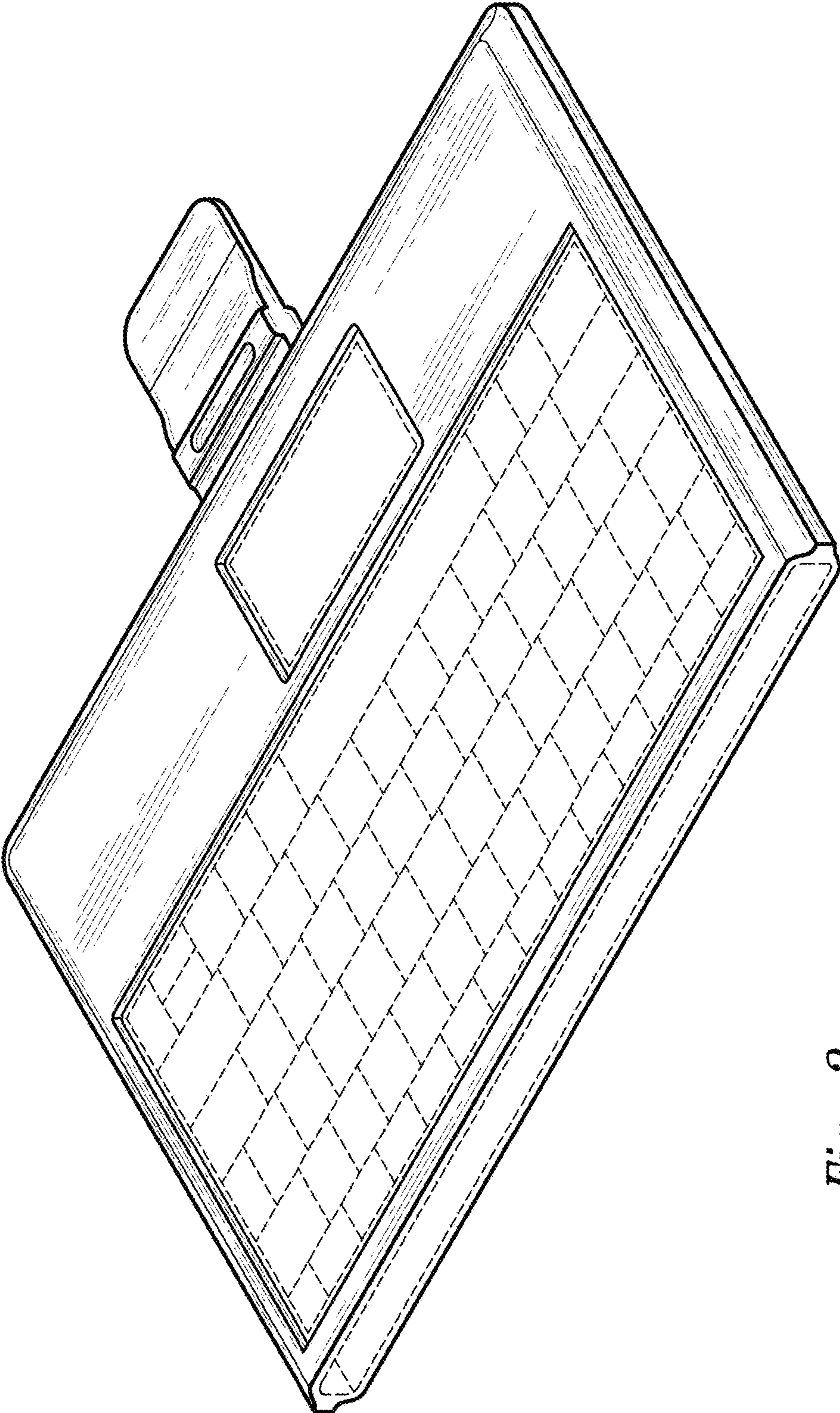
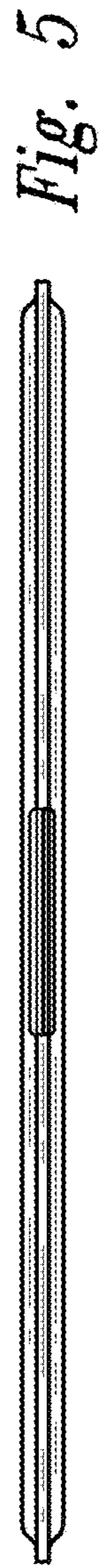
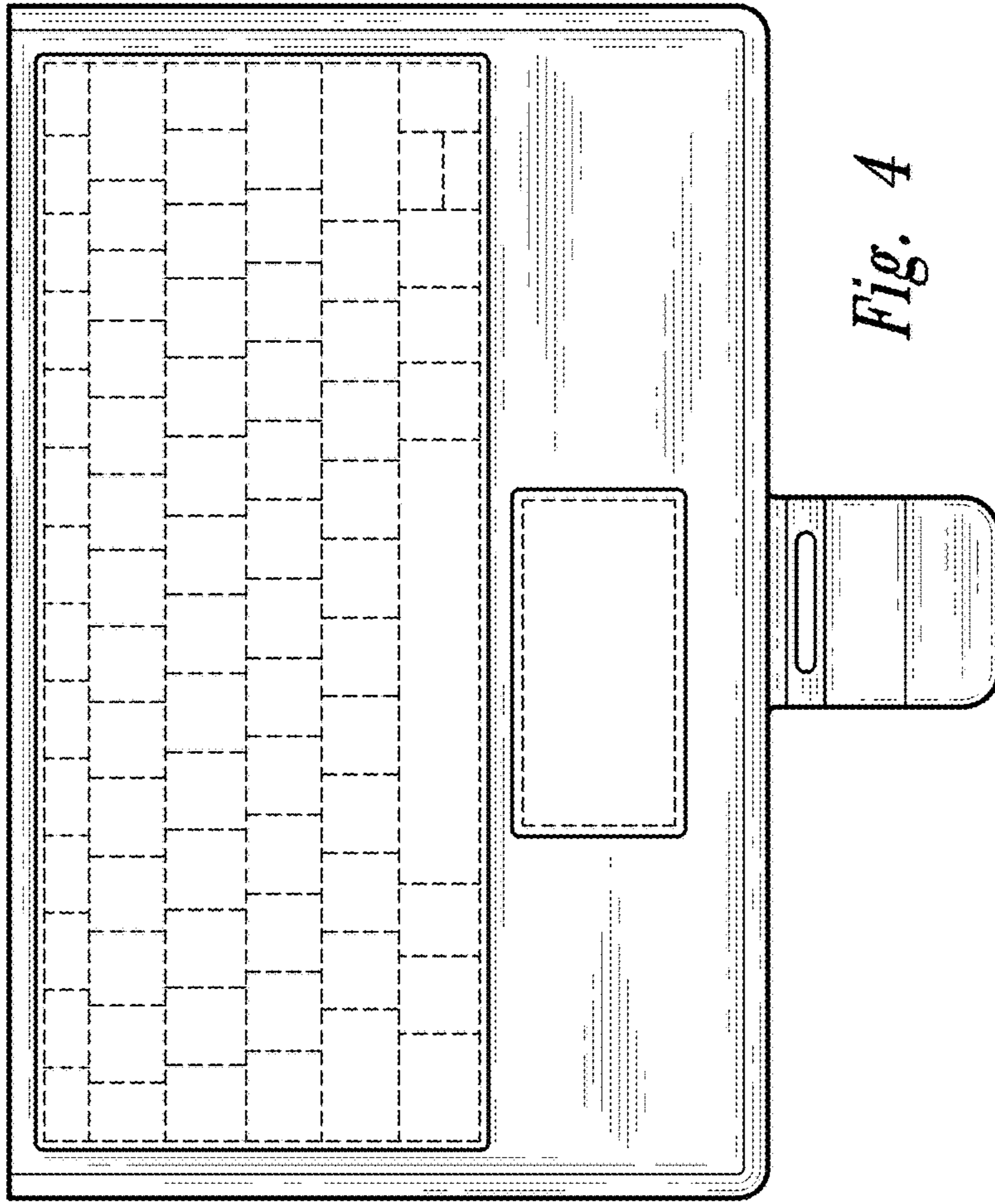
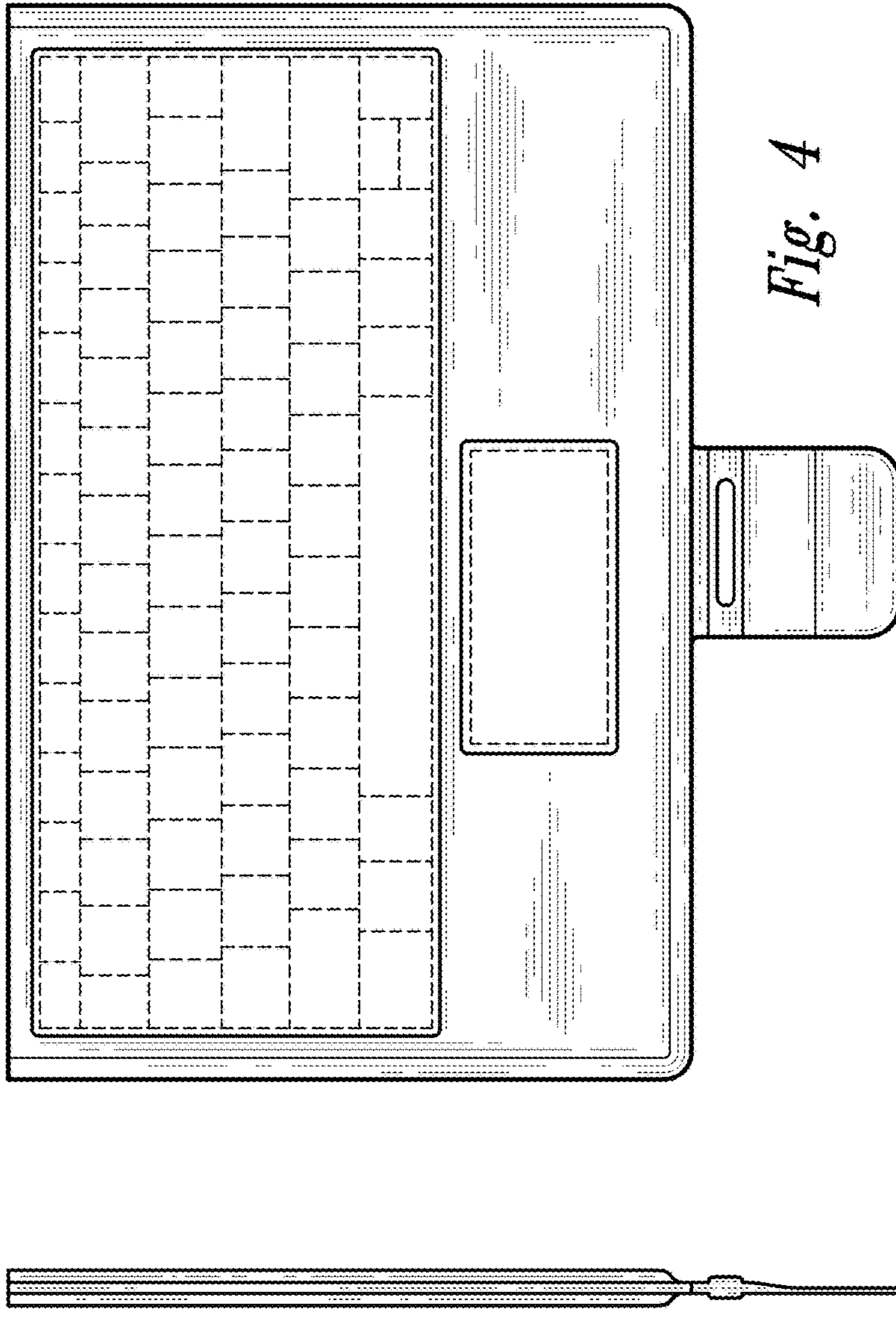
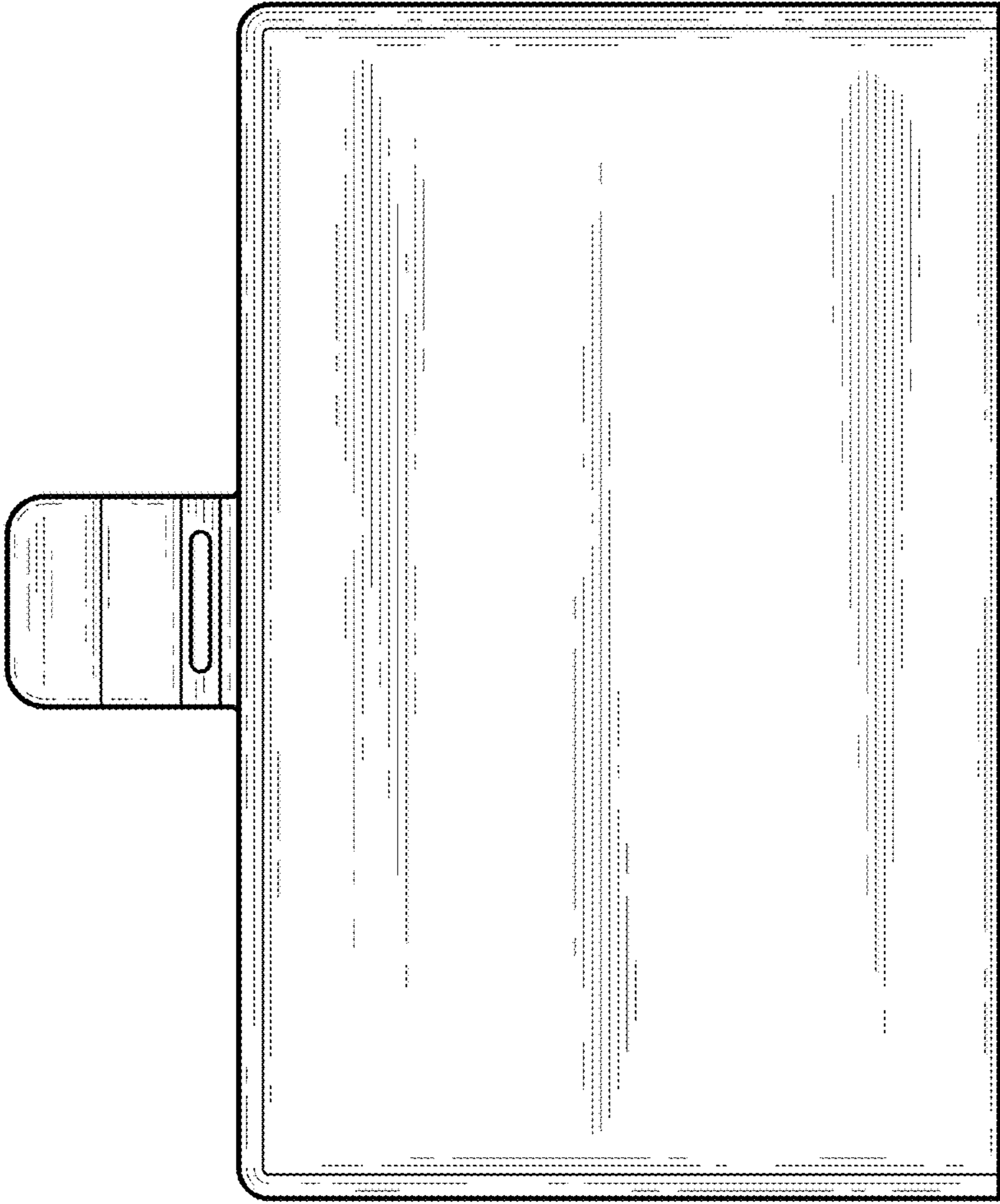

Fig. 2





*Fig. 6*



*Fig. 7*