

US00D854003S

(12) **United States Design Patent**
Kim

(10) **Patent No.:** **US D854,003 S**

(45) **Date of Patent:** **** *Jul. 16, 2019**

(54) **CASE FOR ELECTRONIC COMMUNICATIONS DEVICE**

(71) Applicant: **SPIGEN KOREA CO., LTD.**, Seoul (KR)

(72) Inventor: **Ji Hyun Kim**, Seoul (KR)

(73) Assignee: **SPIGEN KOREA CO., LTD.**, Seoul (KR)

(*) Notice: This patent is subject to a terminal disclaimer.

(**) Term: **15 Years**

(21) Appl. No.: **29/615,800**

(22) Filed: **Aug. 31, 2017**

(51) **LOC (11) Cl.** **14-03**

(52) **U.S. Cl.**
USPC **D14/250**

(58) **Field of Classification Search**

USPC D3/218, 232, 233, 239, 242, 245–251, D3/269, 273, 301, 303; D13/103, 107, D13/108, 119; D14/137, 138 R, 138 AA, D14/138 C, 138 G, 203.3–203.7, 217, D14/238.1, 247, 248, 250, 251–253, 440
CPC H04B 1/3888; H04M 1/0283; H04M 1/0202; A45C 1/06; A45C 2011/002; A45C 11/00; A45F 2005/028; A45F 2200/0525

See application file for complete search history.

(56) **References Cited**

U.S. PATENT DOCUMENTS

D528,110 S *	9/2006	Cohn	D14/248
D575,056 S	8/2008	Tan		
D609,672 S	2/2010	Lee		
D632,685 S	2/2011	Richardson		
D643,029 S	8/2011	Feng		
7,989,085 B2 *	8/2011	Li	H04M 1/0283 174/50

(Continued)

OTHER PUBLICATIONS

Top 20 best iphone 6s cases: The The Heavy Power list, posted at Heavy.com, postingdate Sep. 15, 2015, [online], [site visited Oct. 2, 2017]. Available from Internet, (URL: <https://heavy.com/tech/2015/09/top-best-iphone-6s-cases-cute-wallet-battery-waterproof-water-resistant/>) (Year: 2015).*

(Continued)

Primary Examiner — Susan E Krakower

Assistant Examiner — L. A. Grabenstetter

(74) *Attorney, Agent, or Firm* — Heedong Chae; Lucem, PC

(57) **CLAIM**

The ornamental design for a case for electronic communications device, as shown and described.

DESCRIPTION

FIG. 1 is a front perspective view of a case for electronic communications device showing my new design; FIG. 2 is a rear perspective view thereof; FIG. 3 is a front elevational view thereof; FIG. 4 is a rear elevational view thereof; FIG. 5 is a left side elevational view thereof; FIG. 6 is a right side elevational view thereof; FIG. 7 is a top plan view thereof; FIG. 8 is a bottom plan view thereof; and, FIG. 9 is a partial enlarged view showing the pattern design in FIG. 4.

The interior of the case shown in FIGS. 1 and 3 forms no part of the claimed design.

The dot-dash broken lines in FIGS. 4 and 9 are for the purpose of illustrating the partially enlarged view and form no part of the claimed design. The broken lines, and unshaded surfaces bounded by broken lines, depict parts of the article's appearance that form no part of the claimed design.

1 Claim, 9 Drawing Sheets

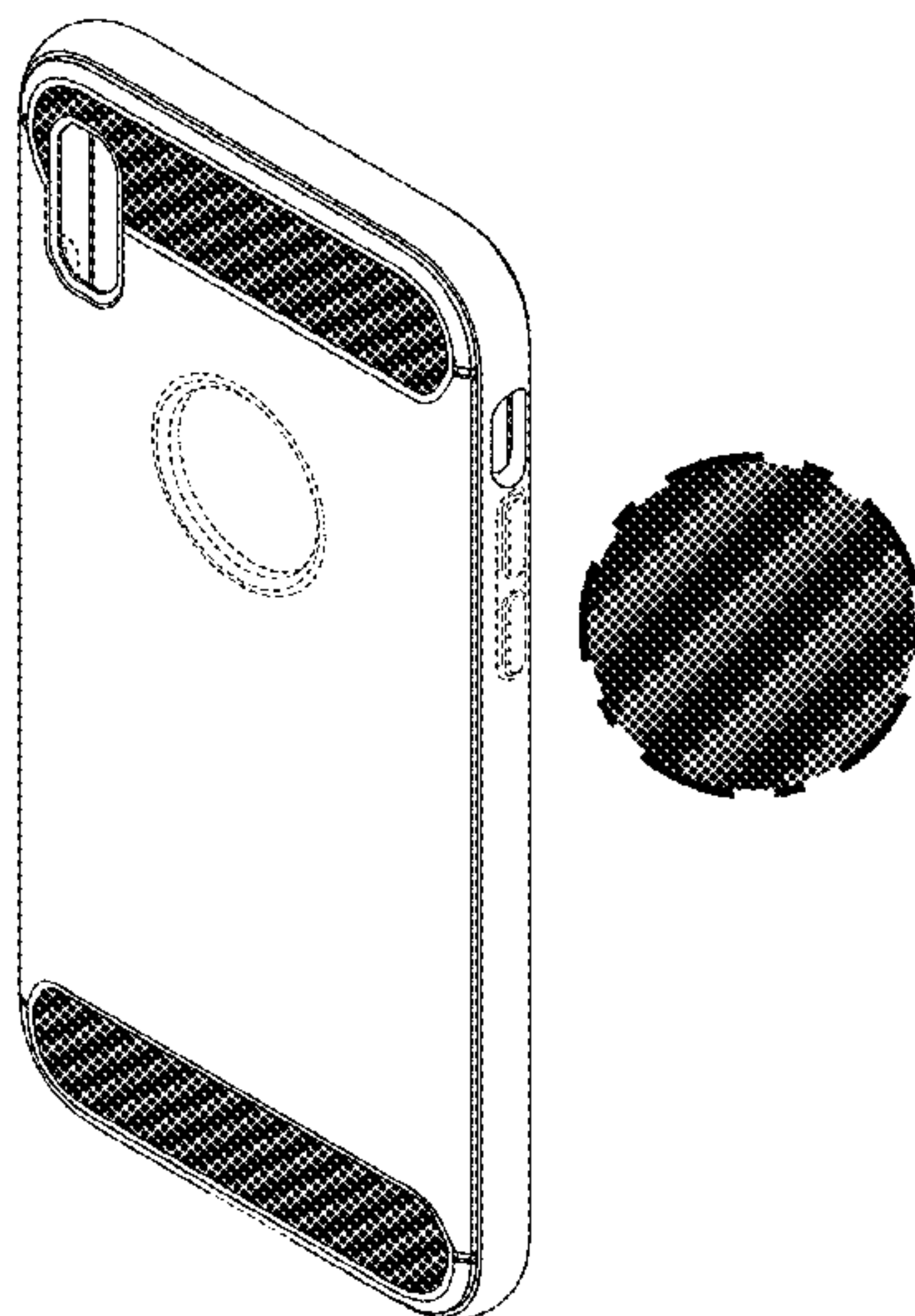

(56)

References Cited

U.S. PATENT DOCUMENTS

D654,487 S * 2/2012 Weller D14/250
 D657,782 S 4/2012 Biller
 D658,164 S * 4/2012 Chan D14/238.1
 D669,071 S 10/2012 Akana et al.
 D671,930 S 12/2012 Akana et al.
 D673,547 S 1/2013 Melanson
 D676,036 S 2/2013 Chang
 D676,844 S 2/2013 Weller
 D679,685 S * 4/2013 Cox D14/250
 D679,697 S 4/2013 Murchison
 D679,698 S 4/2013 Murchison
 D681,022 S 4/2013 Chang
 D681,613 S * 5/2013 Magness D14/238.1
 D682,259 S * 5/2013 Fahrendorff D14/250
 D683,723 S 6/2013 Murchison
 D684,960 S 6/2013 Murchison
 D685,738 S * 7/2013 Moore D13/119
 D685,776 S 7/2013 Bau
 D691,124 S 10/2013 Yang
 D700,174 S 2/2014 Li
 D703,652 S 4/2014 Melanson
 D704,688 S 5/2014 Reivo
 D709,870 S * 7/2014 Lee D14/250
 D712,386 S 9/2014 Lu
 D714,274 S 9/2014 Jung
 D714,276 S 9/2014 Hu
 D714,277 S * 9/2014 Hindaly D14/250
 D715,787 S * 10/2014 Lee D14/250
 D715,789 S * 10/2014 Yoon D14/250
 D717,286 S 11/2014 Veldkamp
 D717,774 S 11/2014 Fathollahi
 D717,778 S 11/2014 Zermeno
 D718,292 S 11/2014 Hemesath
 D718,759 S * 12/2014 Barfoot D14/250
 D721,065 S 1/2015 Yoon
 D721,067 S 1/2015 Su
 D724,572 S * 3/2015 Wildner D14/250
 D727,886 S * 4/2015 Bertrand D14/250
 9,004,275 B2 4/2015 Lee
 D732,012 S * 6/2015 Tsai D14/250
 9,143,181 B1 9/2015 Jia
 D741,845 S 10/2015 Kim
 D743,389 S 11/2015 Akana
 D746,275 S 12/2015 Mohammad
 9,223,346 B2 12/2015 Wilson
 D748,614 S 2/2016 Ju
 D749,068 S 2/2016 Zaborski
 D749,555 S 2/2016 Poon
 9,247,795 B2 2/2016 Kim
 9,293,808 B1 3/2016 Roberts
 D753,099 S 4/2016 Kim
 D756,340 S 5/2016 Babichenko
 D763,841 S 8/2016 Kim
 D764,476 S 8/2016 Gleason, III
 D765,628 S * 9/2016 Watt D14/250
 D765,644 S 9/2016 Witter
 D767,553 S 9/2016 Fathollahi
 D767,554 S * 9/2016 Bertrand D14/250
 D771,607 S 11/2016 Kim
 D771,608 S 11/2016 Kim
 D772,209 S 11/2016 Kim
 D772,854 S 11/2016 Igarashi

D772,858 S 11/2016 Hu
 9,480,318 B2 11/2016 Stiehl
 D774,498 S 12/2016 Tao
 D775,112 S 12/2016 Hemesath
 D775,614 S 1/2017 Kim
 D777,717 S 1/2017 Kim
 D779,470 S 2/2017 Kim
 D781,835 S 3/2017 Kim
 D781,837 S 3/2017 Kim
 D781,838 S 3/2017 Kim
 9,628,133 B2 4/2017 Kim
 9,661,116 B1 5/2017 Chung
 2016/0101902 A1 4/2016 Kim
 2016/0204817 A1 7/2016 Kim
 2016/0285301 A1 9/2016 Kim
 2017/0123217 A1 5/2017 Dukerschein

OTHER PUBLICATIONS

“Spigen Rugged Armor iPhone 8 Case / iPhone 7 Case with Resilient Shock Absorption and Carbon Fiber Design for Apple iPhone 8 (2017) / iPhone 7 (2016)—Black”, <https://www.amazon.co.uk/dp/B01GIVX7TA>, Date first available at Amazon.co.uk of Aug. 2, 2016.
 “Spigen Rugged Armor Galaxy S6 Edge Case with Flexible and Durable Shock Absorption with Carbon Fiber Design for Samsung Galaxy S6 Edge (2015)—Black”, <https://www.amazon.com/dp/B00SVCITW0>, Earliest review date of Mar. 13, 2015.
 “Spigen Rugged Armor Galaxy S7 Edge Case with Flexible and Durable Shock Absorption with Carbon Fiber Design for Samsung Galaxy S7 Edge (2016)—Black”, <https://www.amazon.com/dp/B01A7IDHOU>, Earliest review date of Feb. 28, 2016.
 “Spigen Rugged Armor Galaxy A5 Case with Resilient Shock Absorption and Carbon Fiber Design for Galaxy A5—Black”, <https://www.amazon.com/dp/B018J07A46>, Earliest review date of Mar. 18, 2016.
 “Spigen Rugged Armor Galaxy S6 Case with Resilient Shock Absorption and Carbon Fiber Design for Galaxy S6 2015—Black”, <https://www.amazon.com/dp/B00T6P05ZK>, Earliest review date of Mar. 10, 2015.
 “Spigen Rugged Armor Huawei P8 Lite Case with Resilient Shock Absorption and Carbon Fiber Design for Huawei P8 Lite (2015)—Black”, <https://www.amazon.com/dp/B01DL0DME6>, Earliest review date of Jun. 1, 2016.
 “Spigen Rugged Armor iPhone 6S Case with Resilient Shock Absorption and Carbon Fiber Design for iPhone 6S/iPhone 6—Black”, <https://www.amazon.com/dp/B010MVJM5K>, Earliest review date of Sep. 3, 2015.
 “Spigen Rugged Armor OnePlus 3 Case/OnePlus 3T Case with Resilient Shock Absorption and Carbon Fiber Design for OnePlus 3 2016—Black”, <https://www.amazon.com/dp/B01H3PEWDK>, Earliest review date of Jul. 28, 2016.
 “Spigen Rugged Armor HTC 10 Case with Resilient Shock Absorption and Carbon Fiber Design for HTC 10 2016—Black”, <https://www.amazon.com/dp/B01DAN1T4E>, Earliest review date of May 4, 2016.
 “Spigen Rugged Armor Samsung Galaxy S7 Case with Resilient Shock Absorption and Carbon Fiber Design for Samsung Galaxy S7 2016—Black”, <https://www.amazon.com/dp/B01A7ICWTQ>, Earliest review date of Feb. 25, 2016.

* cited by examiner

FIG. 1

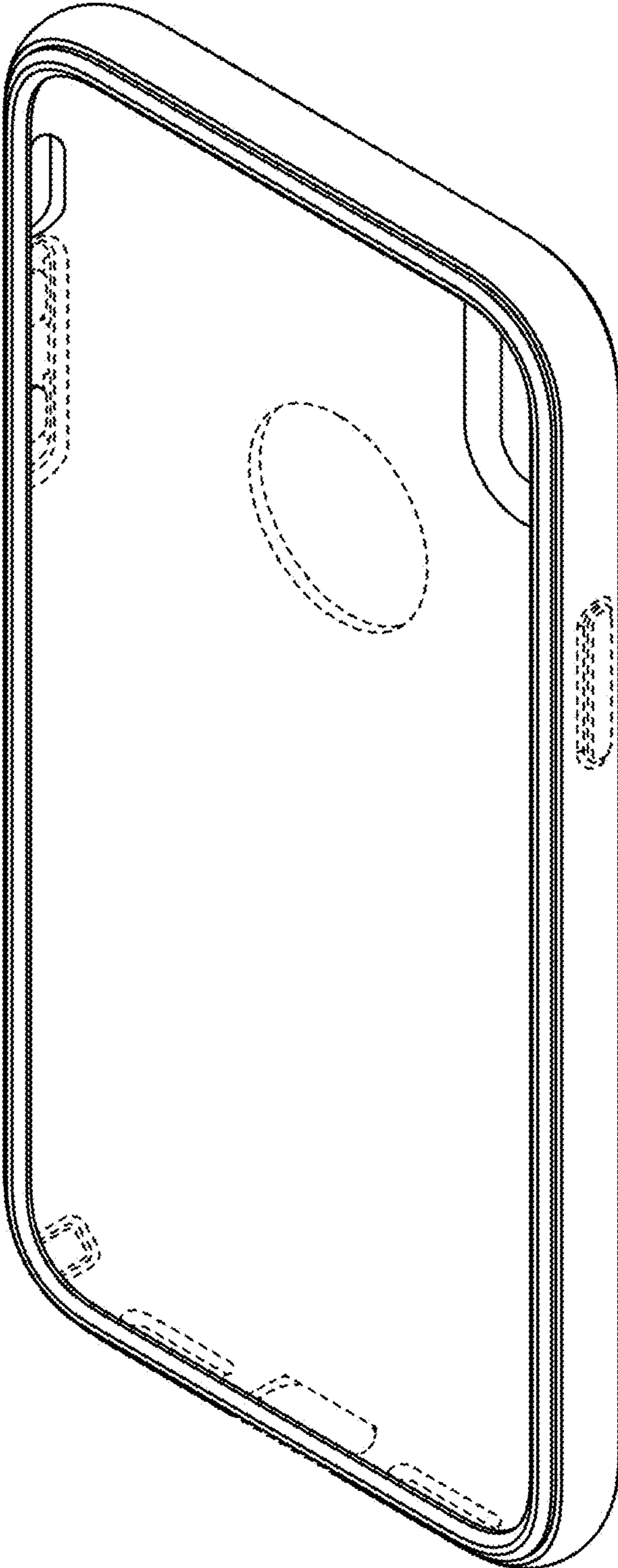

FIG. 2

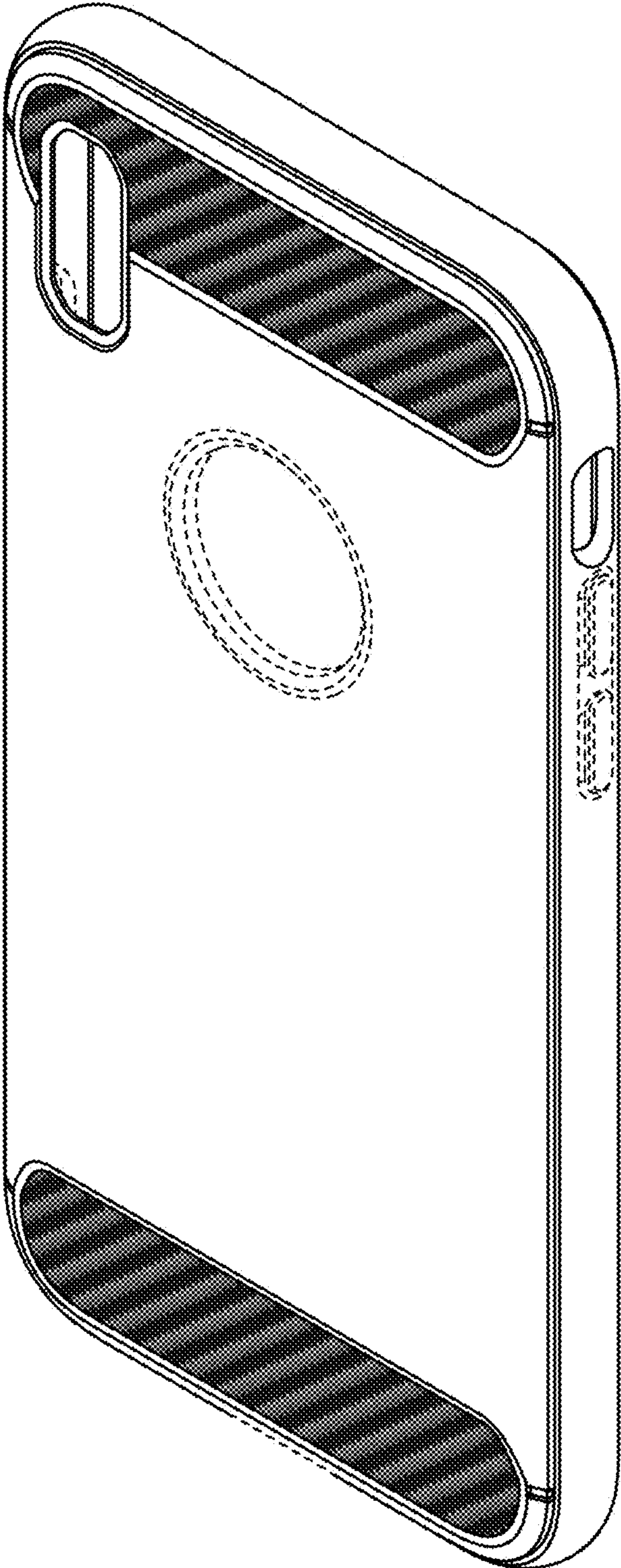

FIG. 3

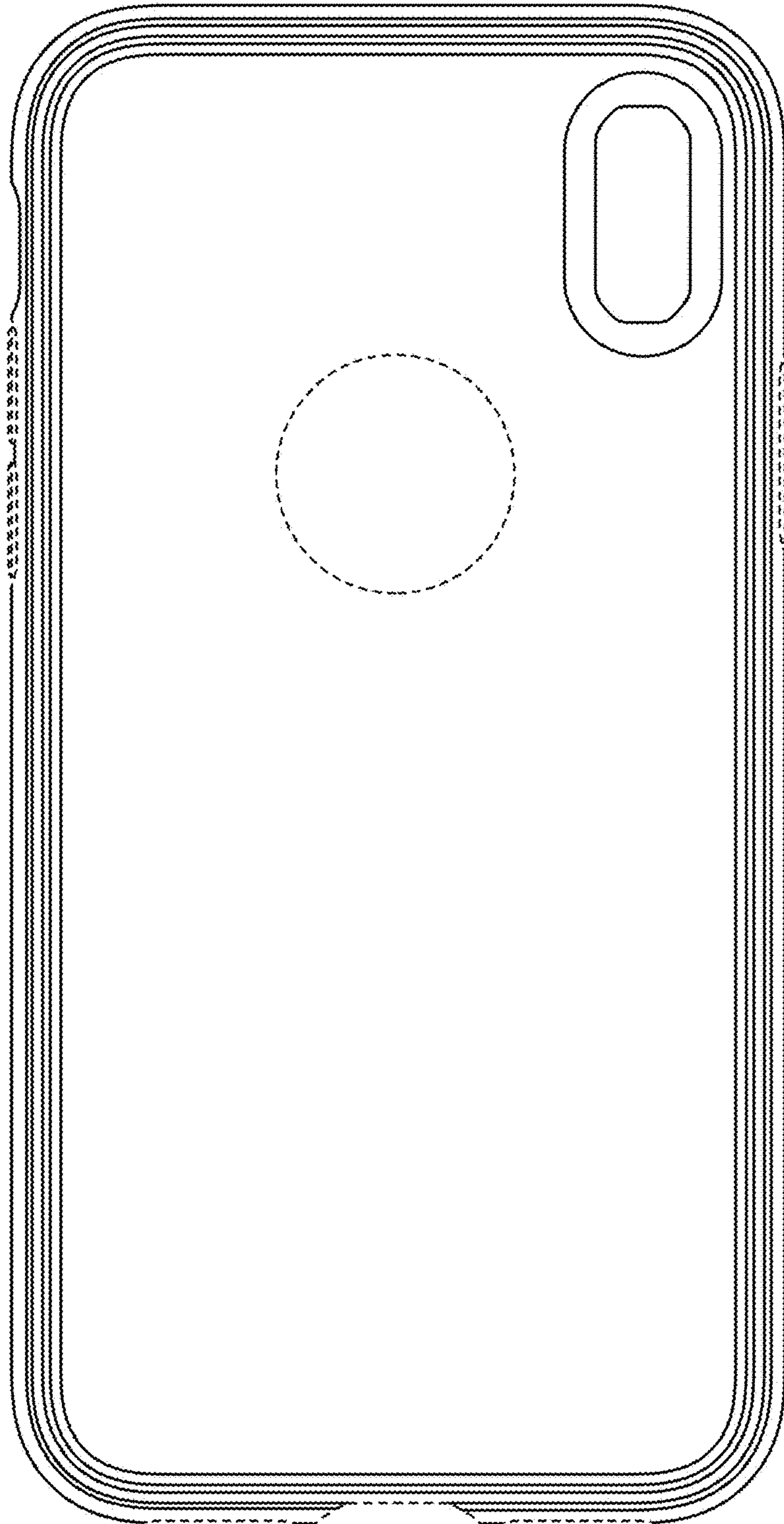

FIG. 4

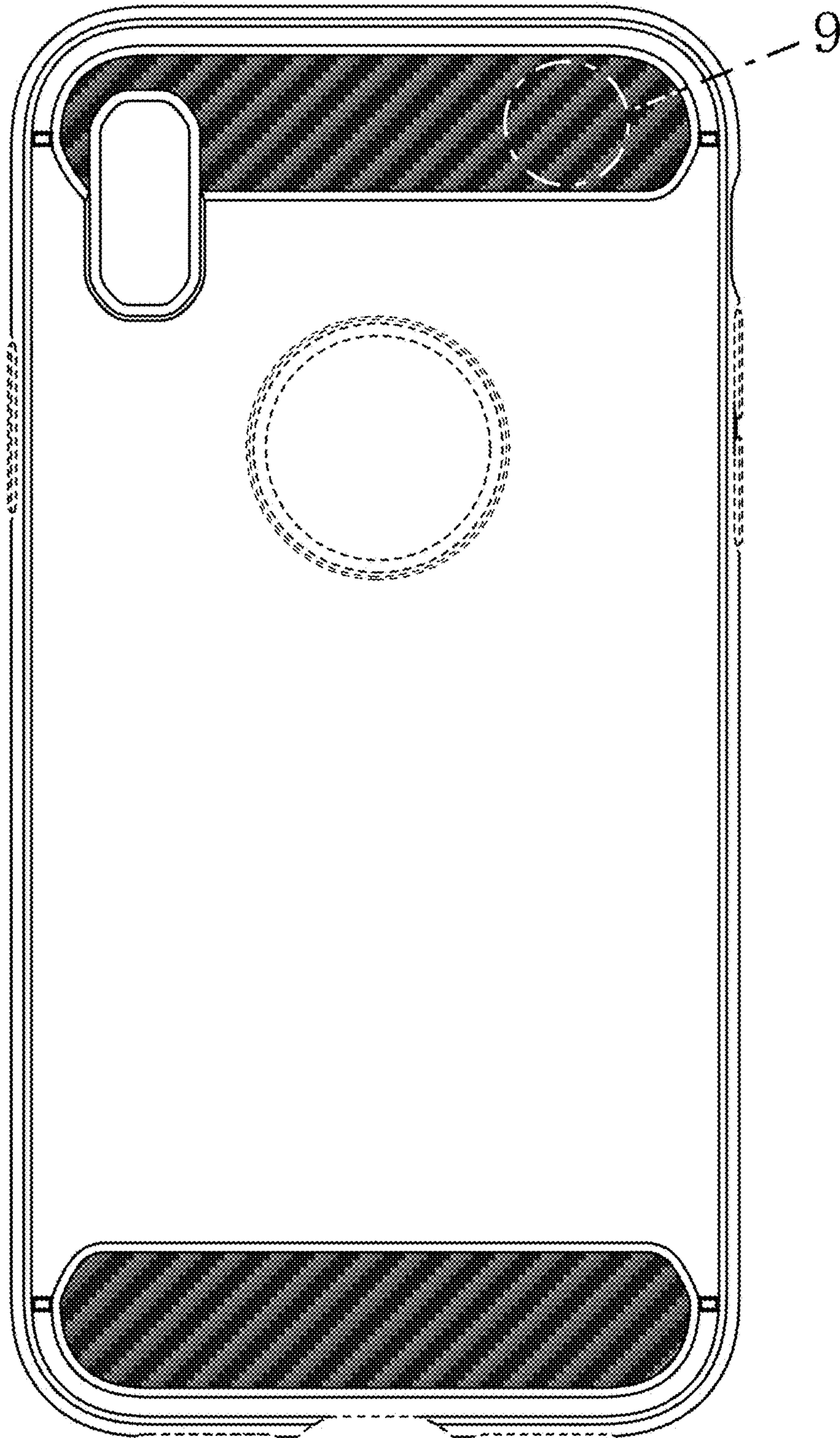

FIG. 5

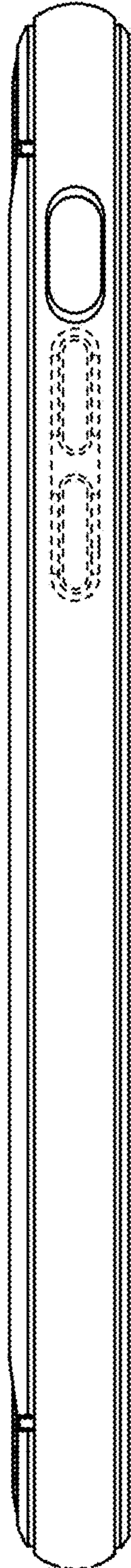

FIG. 6



FIG. 7

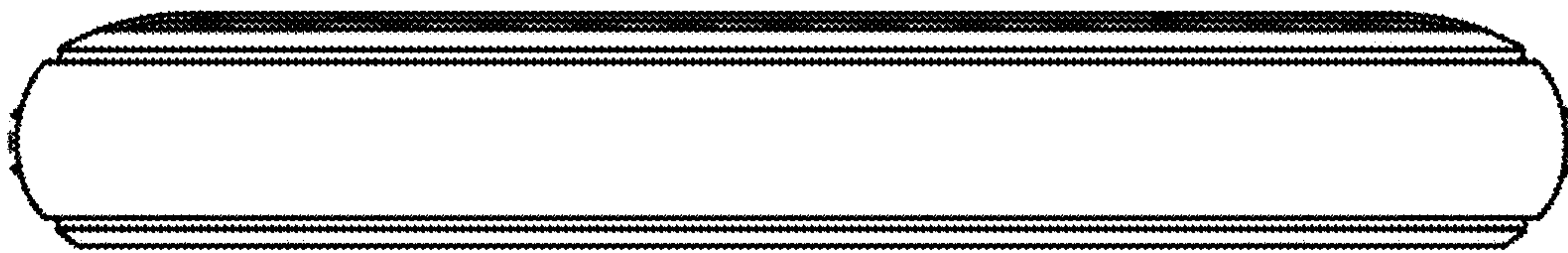

FIG. 8

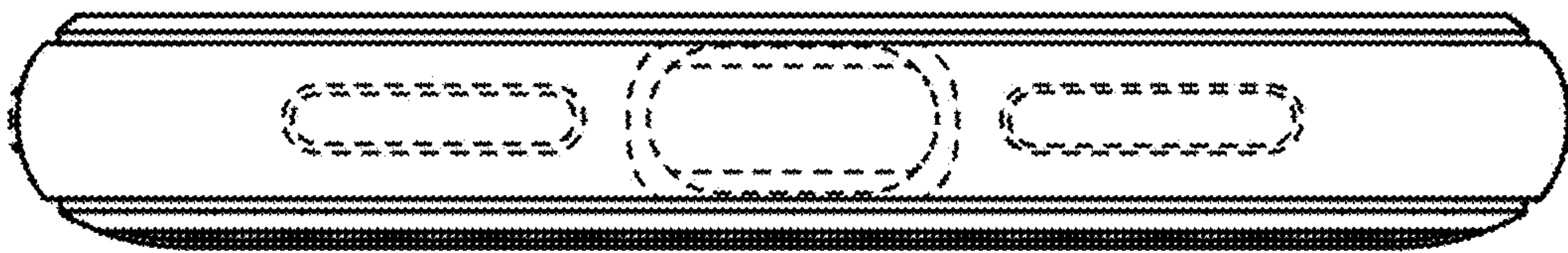

FIG. 9

