



US00D853987S

(12) **United States Design Patent**  
**Kelley et al.**

(10) **Patent No.:** **US D853,987 S**  
(45) **Date of Patent:** **\*\* Jul. 16, 2019**

- (54) **COMMUNICATIONS HEADSET**
- (71) Applicant: **Plantronics, Inc.**, Santa Cruz, CA (US)
- (72) Inventors: **John A. Kelley**, Santa Cruz, CA (US);  
**Joseph W. Yang**, San Jose, CA (US)
- (73) Assignee: **Plantronics, Inc.**, Santa Cruz, CA (US)
- (\*\*) Term: **15 Years**
- (21) Appl. No.: **29/622,496**
- (22) Filed: **Oct. 17, 2017**
- (51) **LOC (11) Cl.** ..... **14-01**
- (52) **U.S. Cl.**  
USPC ..... **D14/205**
- (58) **Field of Classification Search**  
USPC ..... D14/205, 223, 372; 181/129, 130, 135;  
379/430, 431; 381/380, 381, 74, 384,  
381/385, 151; 455/90.3, 575.1, 569.1;  
345/7, 8  
CPC ..... H04R 1/105; H04R 1/10; H04R 1/1066;  
H04R 1/1016; H04R 5/033; H04R  
5/0335; H04R 1/1041  
See application file for complete search history.

(56) **References Cited**

**U.S. PATENT DOCUMENTS**

D371,558 S *	7/1996	Yoshizawa	.....	D14/205
D457,515 S *	5/2002	Masamitsu	.....	D14/192
D458,245 S *	6/2002	Masuda	.....	D14/192
D471,176 S *	3/2003	Suzuki	.....	D14/205
6,603,863 B1 *	8/2003	Nagayoshi	.....	H04R 1/1066 381/370
D492,943 S *	7/2004	Komiyama	.....	D14/205
D557,685 S *	12/2007	Lee	.....	D14/205
D575,268 S *	8/2008	Christopher	.....	D14/205
D584,284 S *	1/2009	Carr	.....	D14/206
D587,679 S *	3/2009	Komiyama	.....	D14/205
D590,810 S *	4/2009	Komiyama	.....	D14/205
D593,067 S *	5/2009	Millora	.....	D14/205
D604,269 S *	11/2009	Choe	.....	D14/205

D633,471 S *	3/2011	Sugiyama	.....	D14/205
D653,234 S *	1/2012	Lee	.....	D14/205
D665,008 S *	8/2012	Olsson	.....	D16/300
D716,759 S *	11/2014	Ha	.....	D14/205
D721,673 S *	1/2015	Park	.....	D14/205

(Continued)

**FOREIGN PATENT DOCUMENTS**

JP D1560011 S 10/2016

**OTHER PUBLICATIONS**

Sinha, "LG, Harman Kardon Unveil tone Infinium (HSB-900) Bluetooth Stereo Headset," May 19, 2014, found at URL < <http://gadgets.ndtv.com/mobiles/news/lg-harman-kardon-unveil-tone-infinium-hsb-900-bluetooth-stereo-headset-526614> >.

(Continued)

*Primary Examiner* — Paula Allen Greene

(57) **CLAIM**

The ornamental design for a communications headset, as shown and described.

**DESCRIPTION**

FIG. 1 is a front-top-right perspective view of a communications headset showing my new design;  
 FIG. 2 is a front-bottom-left perspective view thereof;  
 FIG. 3 is a front view thereof;  
 FIG. 4 is a back view thereof;  
 FIG. 5 is a right side view thereof;  
 FIG. 6 is a left side view thereof;  
 FIG. 7 is a top view thereof; and,  
 FIG. 8 is a bottom view thereof.

The broken lines immediately adjacent to the shaded areas represent the bounds of the claimed design while all other broken lines are directed to environment and are for illustrative purposes only. The broken lines form no part of the claimed design.

**1 Claim, 7 Drawing Sheets**

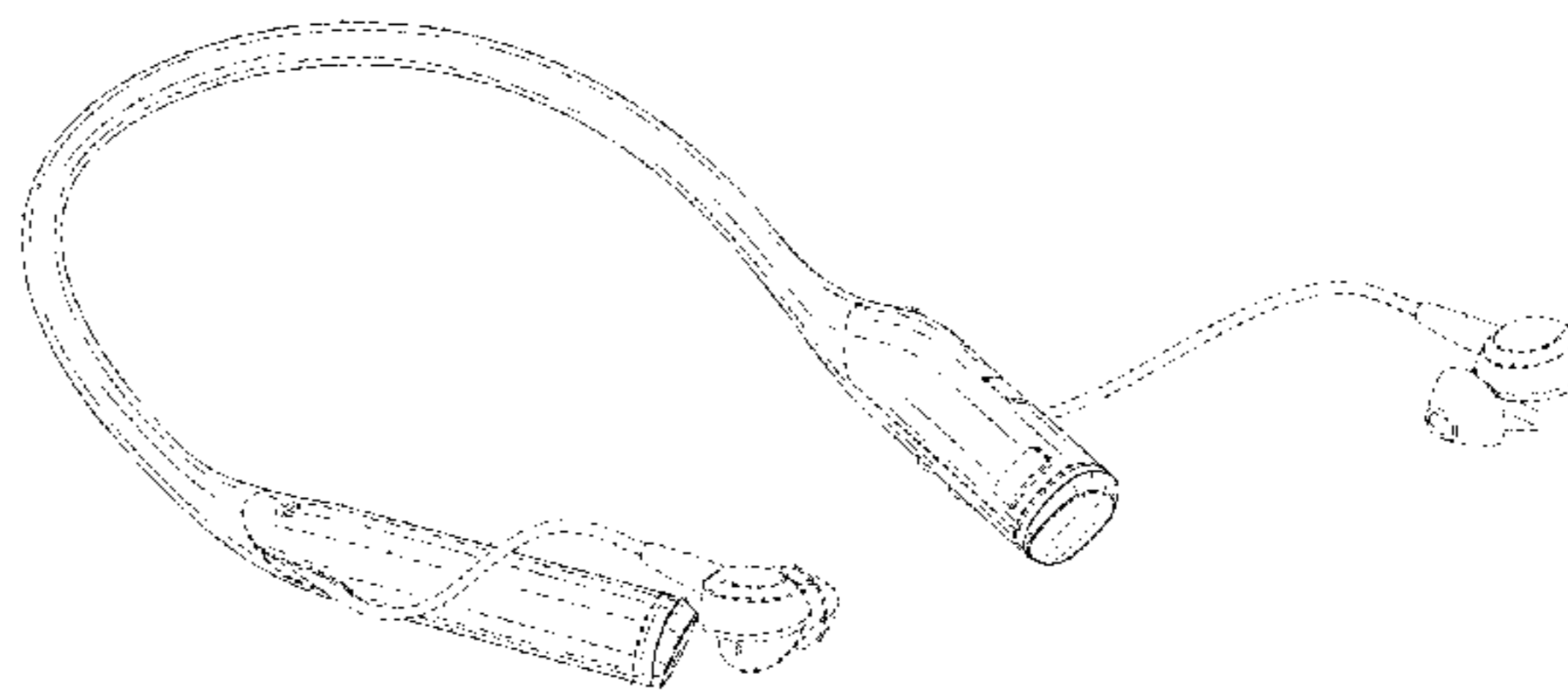
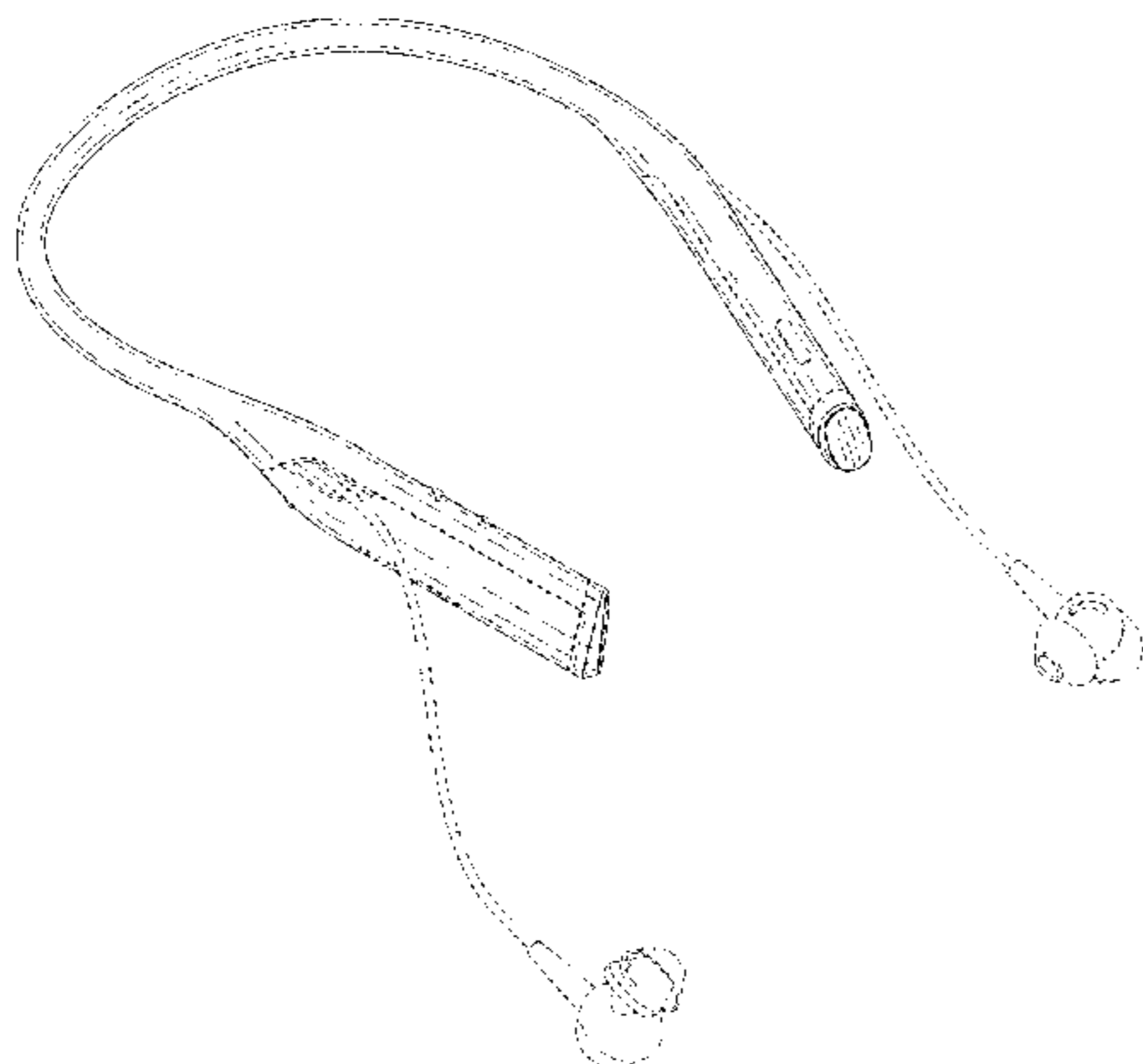

(56)

References Cited

U.S. PATENT DOCUMENTS

8,934,654 B2 \* 1/2015 Fullam ..... H04R 1/028  
 381/381  
 D726,649 S \* 4/2015 Lee ..... D13/103  
 D730,867 S \* 6/2015 Park ..... D14/205  
 D731,999 S \* 6/2015 Ceyress ..... D14/205  
 D743,933 S \* 11/2015 Park ..... D14/205  
 D745,490 S \* 12/2015 Zheng ..... D14/205  
 D762,617 S \* 8/2016 Park ..... D14/205  
 D766,869 S \* 9/2016 Lee ..... D14/205  
 9,445,181 B1 \* 9/2016 Atwater ..... H04R 1/105  
 D768,600 S \* 10/2016 Chen ..... D14/205  
 D771,013 S \* 11/2016 Yang ..... D14/205  
 D771,588 S \* 11/2016 Choe ..... D14/205  
 D772,843 S \* 11/2016 Lee ..... D14/205  
 D772,845 S \* 11/2016 Lim ..... D14/205  
 D774,017 S \* 12/2016 Ahn ..... D14/205  
 D776,636 S \* 1/2017 Lim ..... D14/205  
 D777,136 S \* 1/2017 Erbeus ..... D14/205  
 D781,815 S \* 3/2017 Choi ..... D14/205  
 D781,816 S \* 3/2017 Choe ..... D14/205  
 D786,216 S \* 5/2017 Silva ..... D14/205  
 D793,357 S \* 8/2017 Afshar ..... D14/205  
 D793,358 S \* 8/2017 Lee ..... D14/205  
 D795,836 S \* 8/2017 Liden ..... D14/205  
 D800,088 S \* 10/2017 Kim ..... D14/205  
 D800,089 S \* 10/2017 Park ..... D14/205  
 D800,090 S \* 10/2017 Ahn ..... D14/205  
 D802,557 S \* 11/2017 Kumano ..... D14/205  
 D802,558 S \* 11/2017 Kim ..... D14/205  
 D803,186 S \* 11/2017 Park ..... D14/205  
 D810,719 S \* 2/2018 Nagamine ..... D14/205  
 D814,443 S \* 4/2018 Sandanger ..... A61F 11/08  
 D14/223  
 D815,068 S \* 4/2018 Huang ..... D14/223  
 D816,636 S \* 5/2018 Birger ..... D14/205  
 9,973,842 B2 \* 5/2018 Kim ..... H04R 1/1025  
 D820,811 S \* 6/2018 Kim ..... D14/205  
 D820,816 S \* 6/2018 Singh ..... D14/223  
 D823,828 S \* 7/2018 Park ..... D14/205  
 D824,361 S \* 7/2018 Park ..... D14/205  
 D824,877 S \* 8/2018 Kim ..... D14/205  
 D826,898 S \* 8/2018 Kim ..... D14/205  
 D826,899 S \* 8/2018 Ahn ..... D14/205  
 D826,988 S \* 8/2018 Forsberg ..... D14/495  
 D828,826 S \* 9/2018 Schaal ..... D14/223

D830,335 S \* 10/2018 Shin ..... D14/205  
 D830,995 S \* 10/2018 Shin ..... D14/205  
 D830,996 S \* 10/2018 Park ..... D14/205  
 D830,997 S \* 10/2018 Park ..... D14/205  
 D830,999 S \* 10/2018 Kim ..... D14/205  
 D831,611 S \* 10/2018 Kim ..... D14/205  
 10,104,463 B2 \* 10/2018 Kim ..... H04R 1/1041  
 D837,184 S \* 1/2019 Zhu ..... D14/205  
 2009/0274335 A1 \* 11/2009 Cheung ..... H04R 5/0335  
 381/374  
 2011/0170702 A1 \* 7/2011 Bays ..... H04R 5/0335  
 381/74  
 2013/0156250 A1 \* 6/2013 Hsu Huang ..... H04R 1/1075  
 381/385  
 2015/0264474 A1 \* 9/2015 Seo ..... G06F 3/165  
 381/74  
 2015/0382095 A1 \* 12/2015 Shin ..... H04R 1/1033  
 242/385.4  
 2016/0037428 A1 \* 2/2016 Kanugovi ..... H04L 69/16  
 370/329  
 2016/0050487 A1 \* 2/2016 Kim ..... H04R 1/323  
 381/74  
 2016/0366506 A1 \* 12/2016 Kim ..... H04R 5/0335  
 2017/0070801 A1 \* 3/2017 Nguyen ..... H04R 1/105  
 2017/0195768 A1 \* 7/2017 Kim ..... H04B 1/034  
 2017/0311072 A1 \* 10/2017 Seo ..... H04M 1/02  
 2017/0347192 A1 \* 11/2017 Seo ..... H04R 5/02  
 2018/0063620 A1 \* 3/2018 Kim ..... H04R 1/1025

OTHER PUBLICATIONS

Miller, "Wireless LG 'neckband' headphones get the Platinum treatment," Feb. 17, 2016, found at URL < <https://www.cnet.com/products/lg-tone-platinum-hbs-1100/> >.  
 Norris, "LG Tone Pro review: the best, most discrete wireless headset yet," Oct. 14, 2014, found at URL < <http://gearburn.com/2014/10/lg-tone-pro-review-the-best-most-discreet-wireless-headset-yet/> >.  
 Lendino, "LG HBS-700," Apr. 12, 2011, found at URL < <http://www.pcmag.com/article2/0,2817,2383392,00.asp> >.  
 Singh, "Communications Headset," Design U.S. Appl. No. 29/572,894, filed Aug. 1, 2016, 12 pages.  
 Taiwan IPO Search Report issued in Taiwan Design Application No. 107302034, completed Sep. 21, 2018 and English translation thereof, 2 pages.

\* cited by examiner

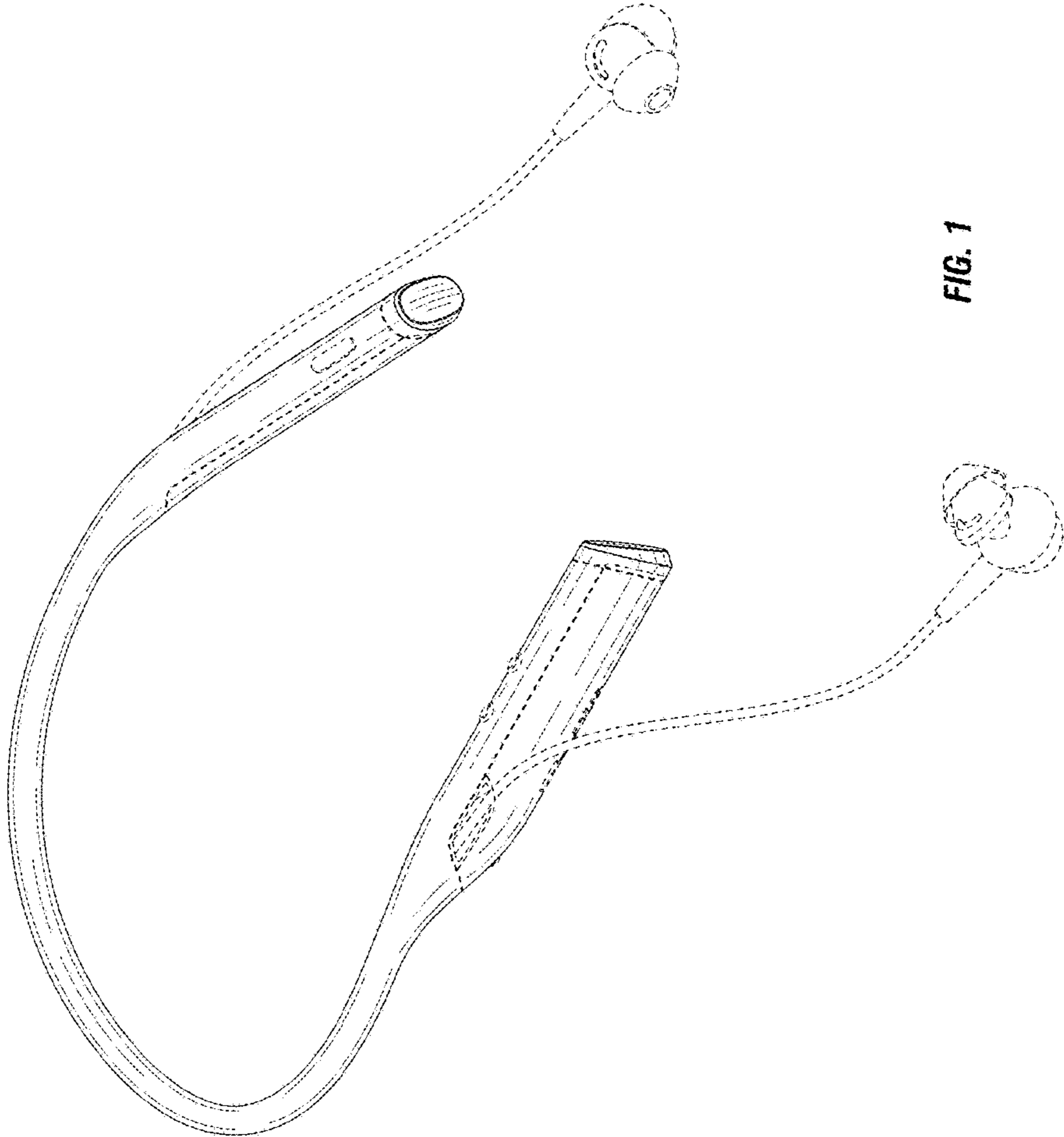

FIG. 1



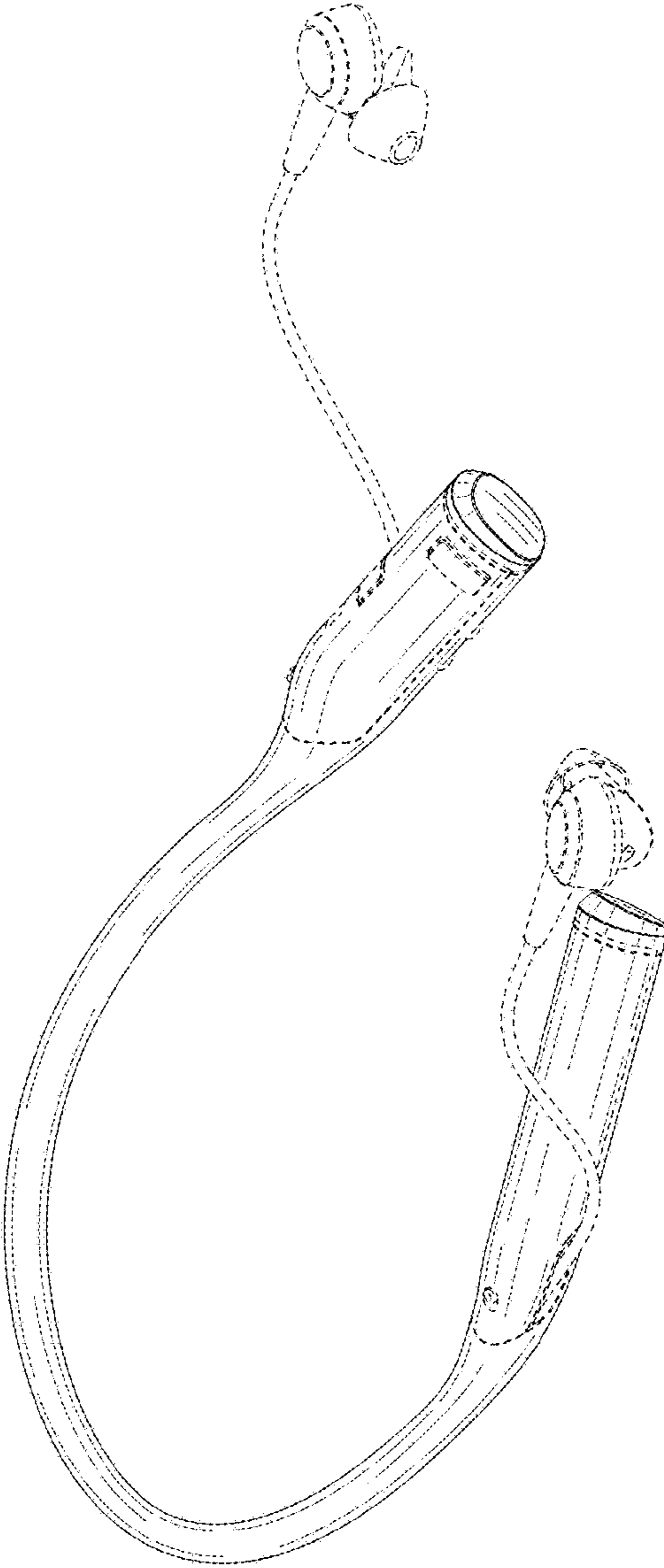

FIG. 2

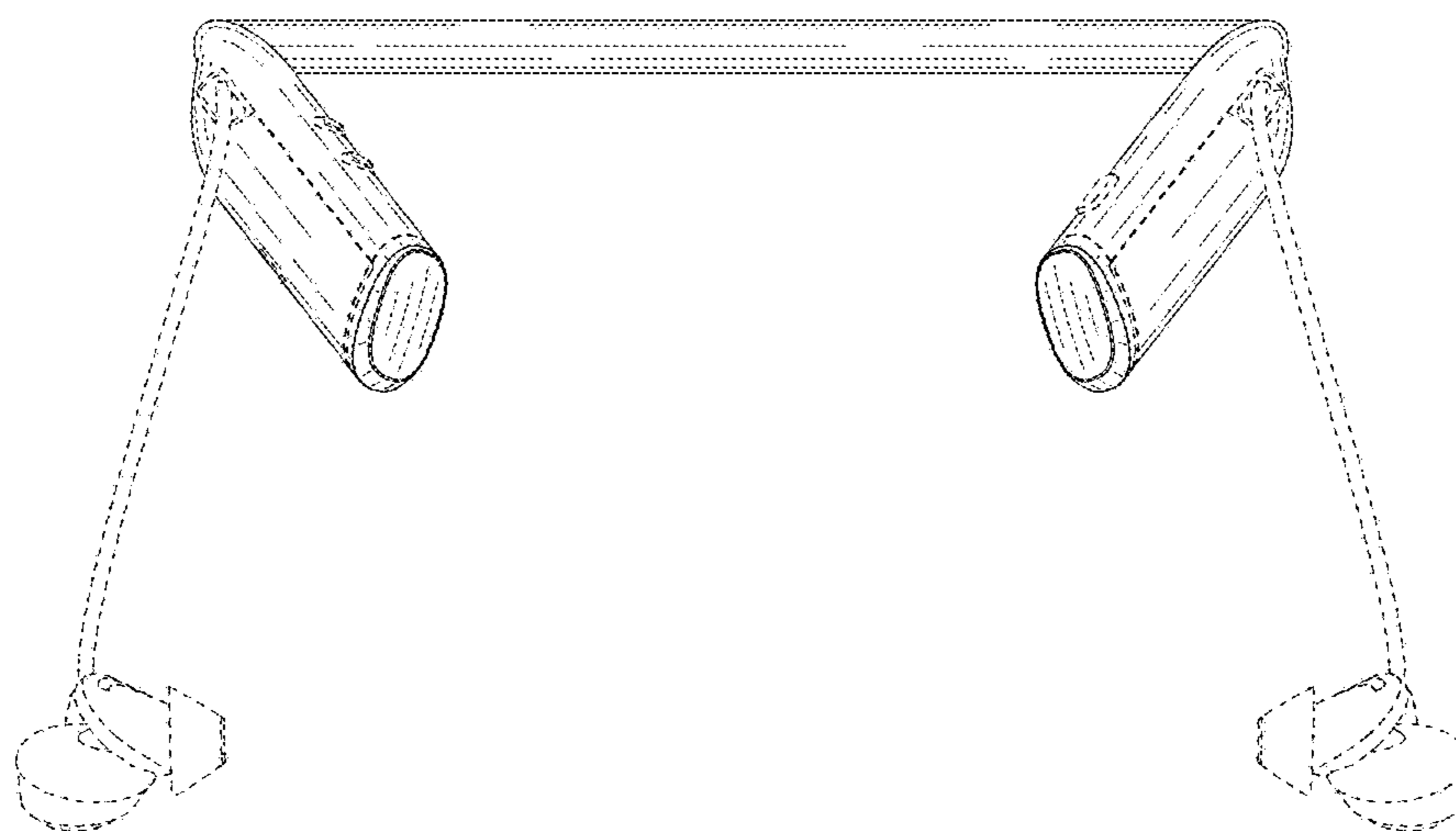

FIG. 3

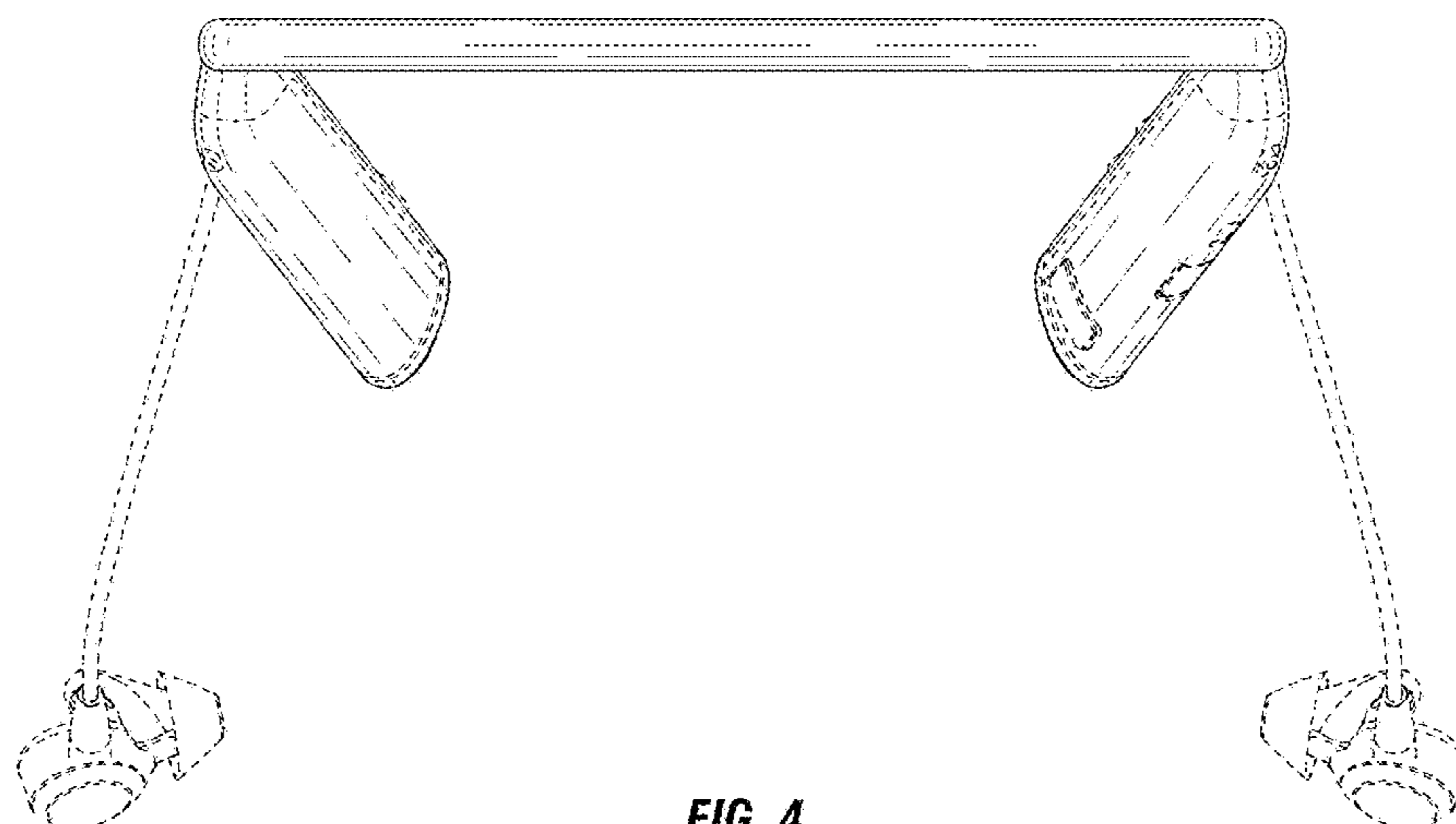

FIG. 4

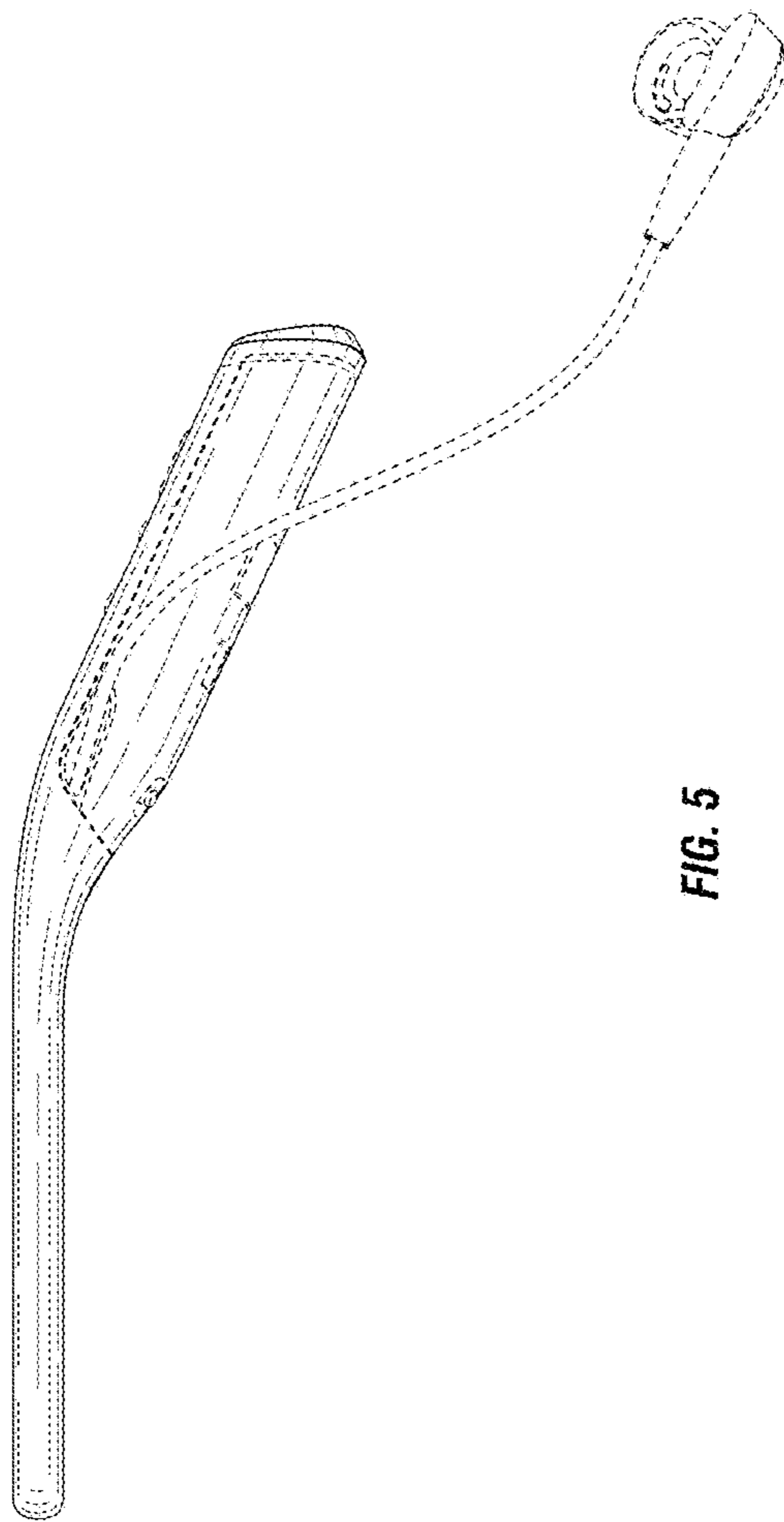
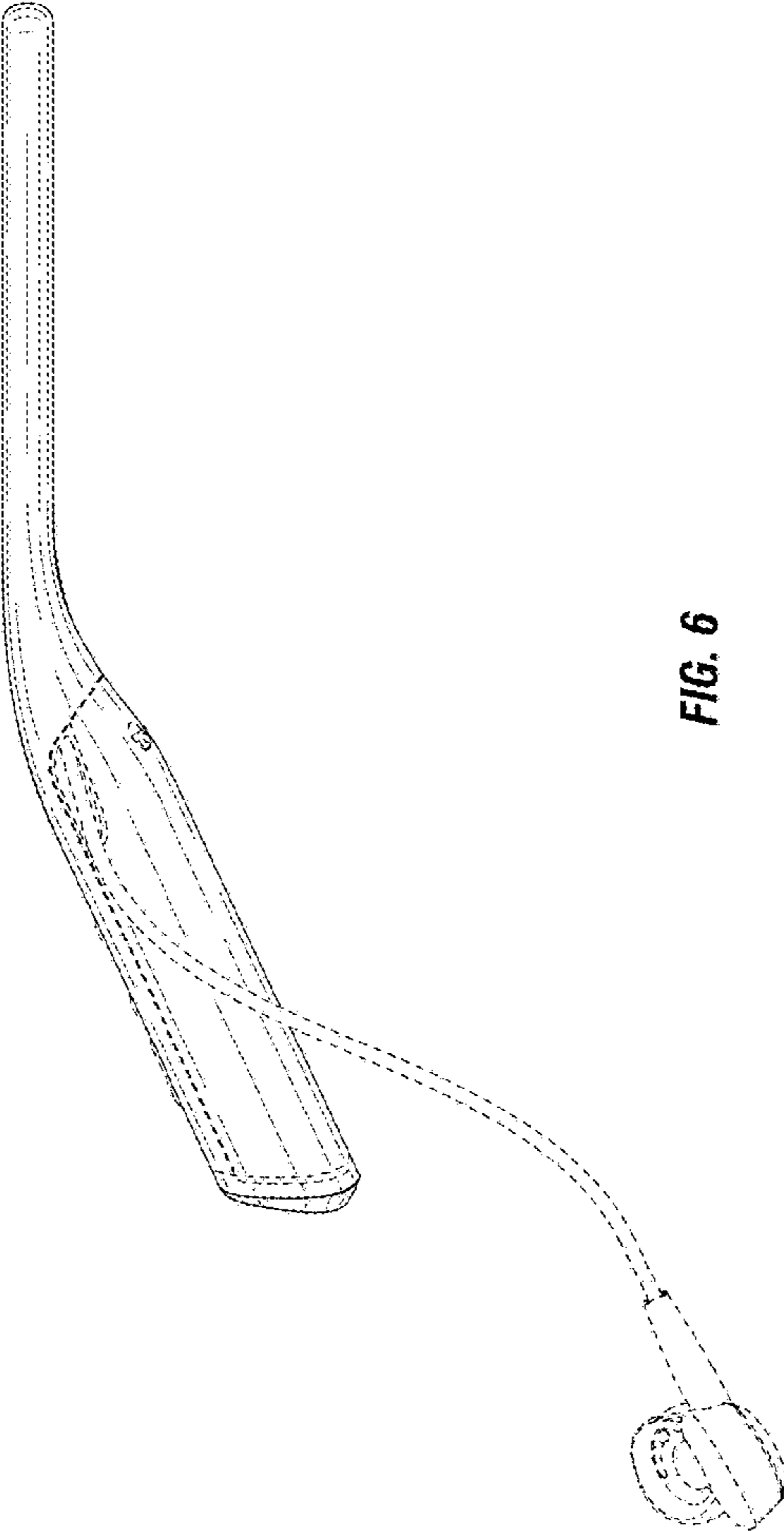

FIG. 5



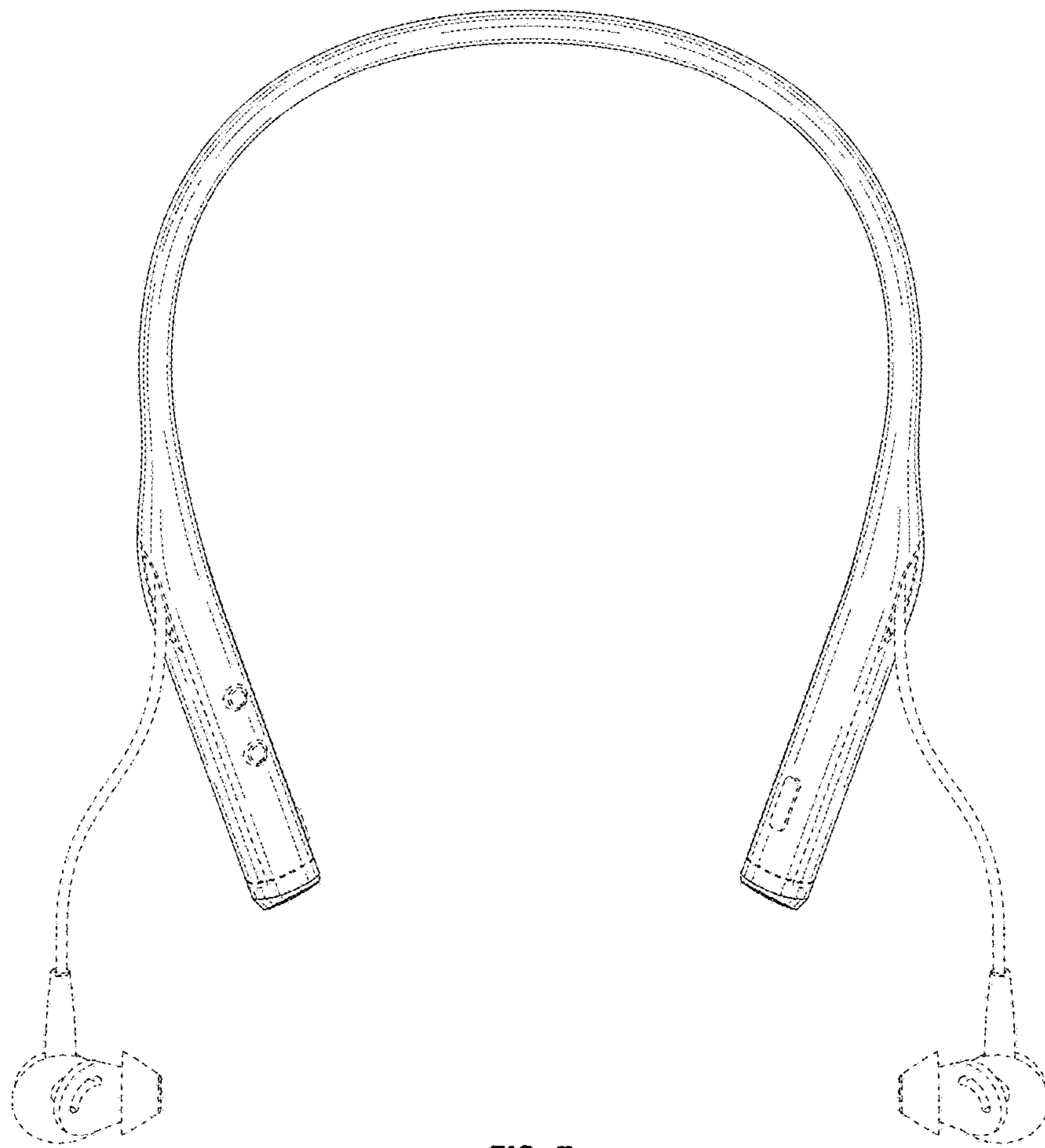

FIG. 7



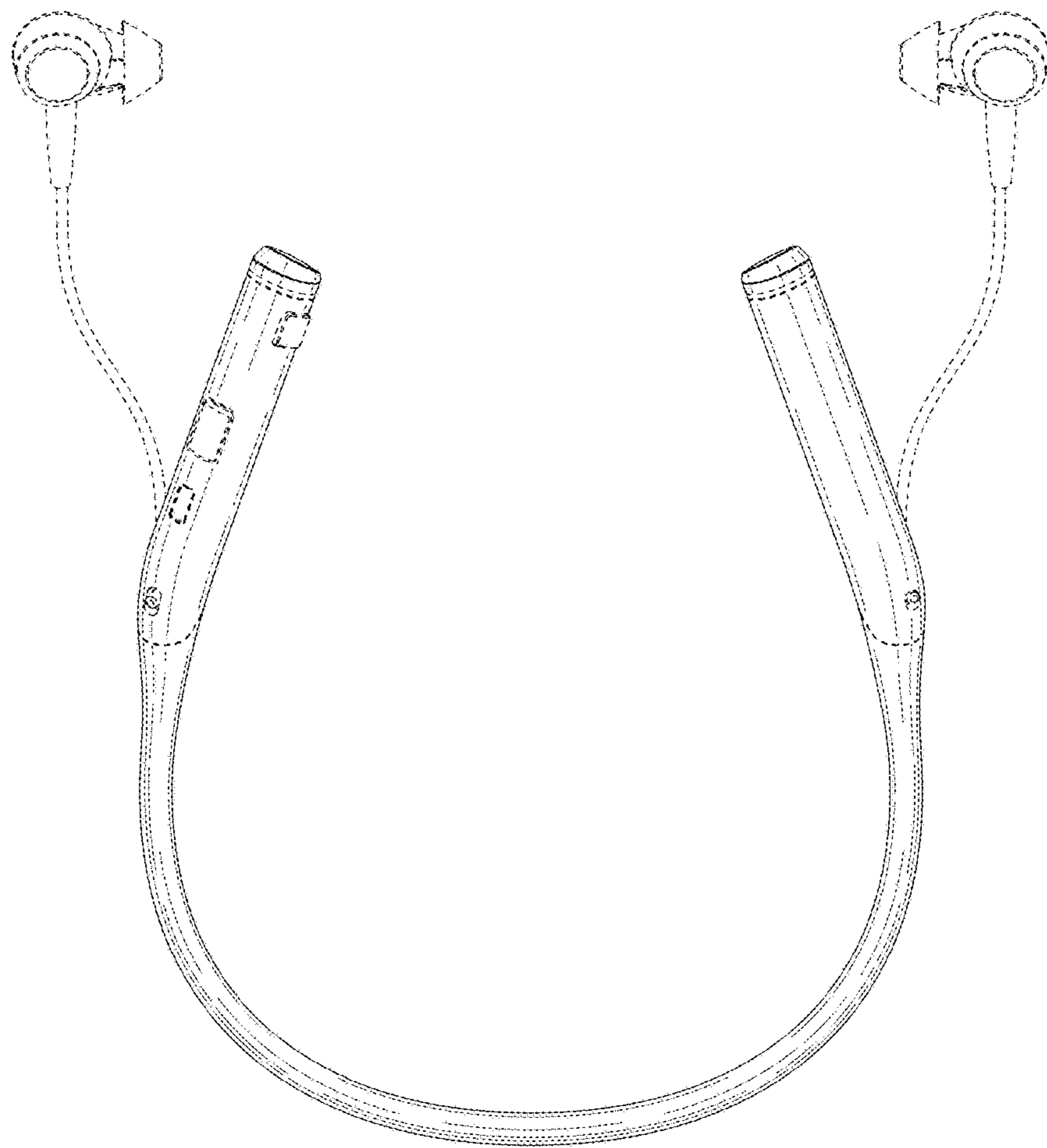

FIG. 8