

US00D853952S

(12) **United States Design Patent**  
**Kamada**

(10) **Patent No.:** **US D853,952 S**  
(45) **Date of Patent:** **\*\* Jul. 16, 2019**

- (54) **TIRE SIDEWALL**
- (71) Applicant: **BRIDGESTONE CORPORATION**,  
Tokyo (JP)
- (72) Inventor: **Shiho Kamada**, Tokyo (JP)
- (73) Assignee: **BRIDGESTONE CORPORATION**,  
Tokyo (JP)
- (\*\*) Term: **15 Years**
- (21) Appl. No.: **29/644,790**
- (22) Filed: **Apr. 20, 2018**
- (30) **Foreign Application Priority Data**  
Oct. 27, 2017 (JP) ..... 2017-023936
- (51) **LOC (11) Cl.** ..... **12-15**
- (52) **U.S. Cl.**  
USPC ..... **D12/605**
- (58) **Field of Classification Search**  
USPC ..... D12/604, 605  
CPC ..... B60C 13/00; B60C 1/00  
See application file for complete search history.

- (56) **References Cited**  
U.S. PATENT DOCUMENTS  
D403,634 S \* 1/1999 Ratliff, Jr. .... D12/605  
D449,576 S \* 10/2001 Kajikawa ..... D12/605  
D450,034 S \* 11/2001 Kajikawa ..... D12/605  
D452,203 S \* 12/2001 Kajikawa ..... D12/605  
D475,345 S \* 6/2003 Endo ..... D12/605  
D542,218 S \* 5/2007 Maxwell ..... D12/605  
D542,219 S \* 5/2007 Shondel ..... D12/605  
D549,166 S \* 8/2007 Lee ..... D12/605  
D554,577 S \* 11/2007 Miyazaki ..... D12/605  
D565,502 S \* 4/2008 Miyazaki ..... D12/605  
D568,806 S \* 5/2008 Dixon ..... D12/605

- D569,335 S \* 5/2008 Lee ..... D12/605
- D570,768 S \* 6/2008 Takahashi ..... D12/605
- D575,222 S \* 8/2008 Fujita ..... D12/605
- D585,017 S \* 1/2009 Shondel ..... D12/605
- D588,530 S \* 3/2009 Shondel ..... D12/605
- D588,533 S \* 3/2009 Shondel ..... D12/605
- D596,116 S \* 7/2009 Fujita ..... D12/605
- D611,403 S \* 3/2010 Kuwano ..... D12/605
- D627,714 S \* 11/2010 Miyazaki ..... D12/605
- D640,188 S \* 6/2011 Strader ..... D12/605
- D662,466 S \* 6/2012 Takano ..... D12/605
- D735,126 S \* 7/2015 Rittweger ..... D12/605
- D791,693 S \* 7/2017 Iwabuchi ..... D12/605
- D803,149 S \* 11/2017 Ishikawa ..... D12/605
- D806,643 S \* 1/2018 Yasunaga ..... D12/605
- D808,333 S \* 1/2018 Iwabuchi ..... D12/605

(Continued)

*Primary Examiner* — Michelle E. Wilson  
*Assistant Examiner* — Clese Moore, Jr.  
(74) *Attorney, Agent, or Firm* — Sughrue Mion, PLLC

(57) **CLAIM**

The ornamental design for a tire sidewall, as shown and described.

**DESCRIPTION**

FIG. 1 is a front view of a tire sidewall showing my new design;  
FIG. 2 is a top view thereof;  
FIG. 3 is a right side view thereof;  
FIG. 4 is a left side view thereof;  
FIG. 5 is a rear view thereof;  
FIG. 6 is a bottom view thereof;  
FIG. 7 is an end view taken along line 7-7 in FIG. 1; and,  
FIG. 8 is a fragmentary enlarged view taken along line 8-8 in FIG. 7.  
Broken lines in the drawings are intended to show portions of the tire that are not being claimed, and thus form no part of the claimed invention.

**1 Claim, 8 Drawing Sheets**

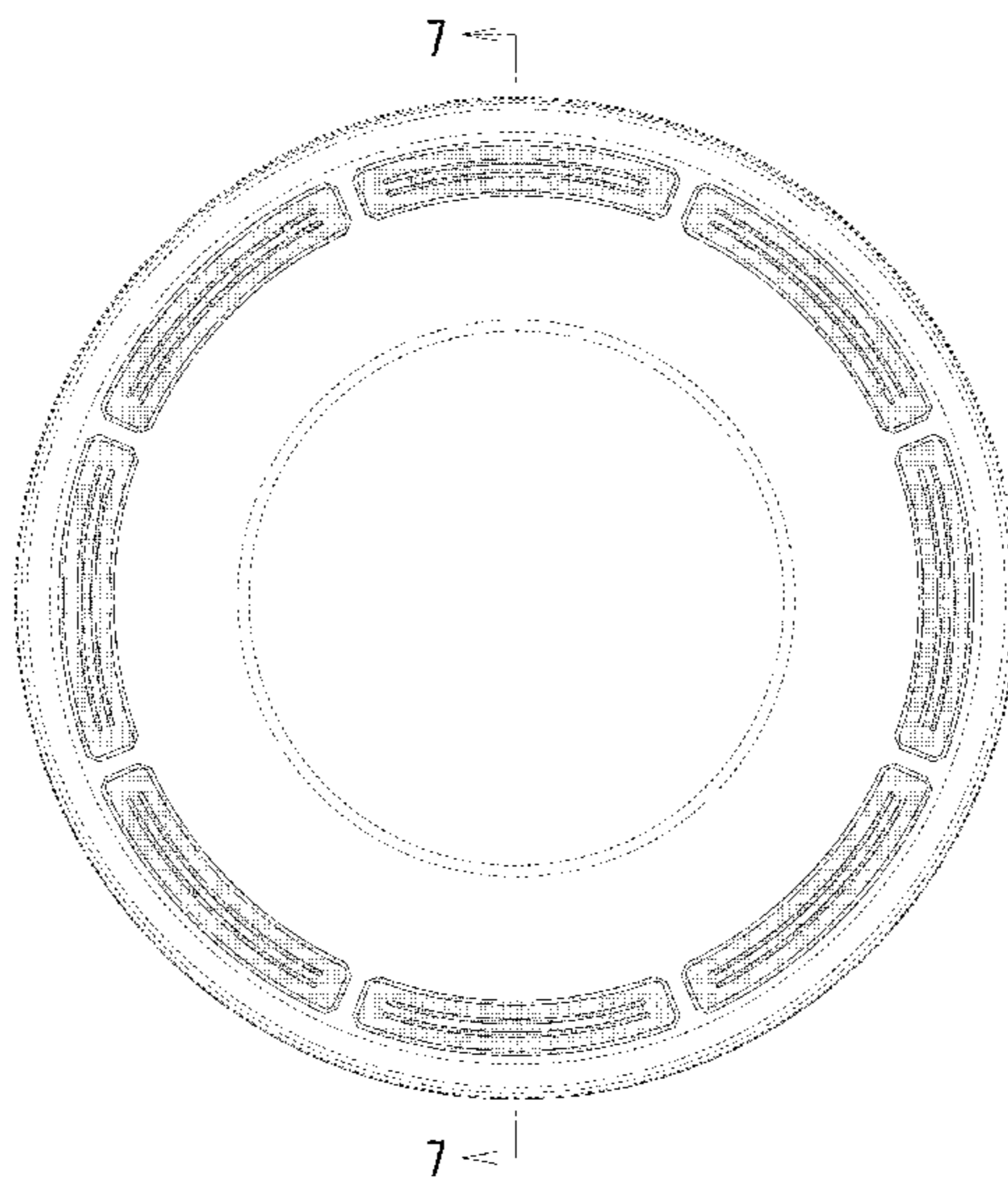

(56)

**References Cited**

U.S. PATENT DOCUMENTS

D810,674 S \* 2/2018 Itoi ..... D12/605  
D814,394 S \* 4/2018 Wuescher ..... D12/605

\* cited by examiner

FIG. 1

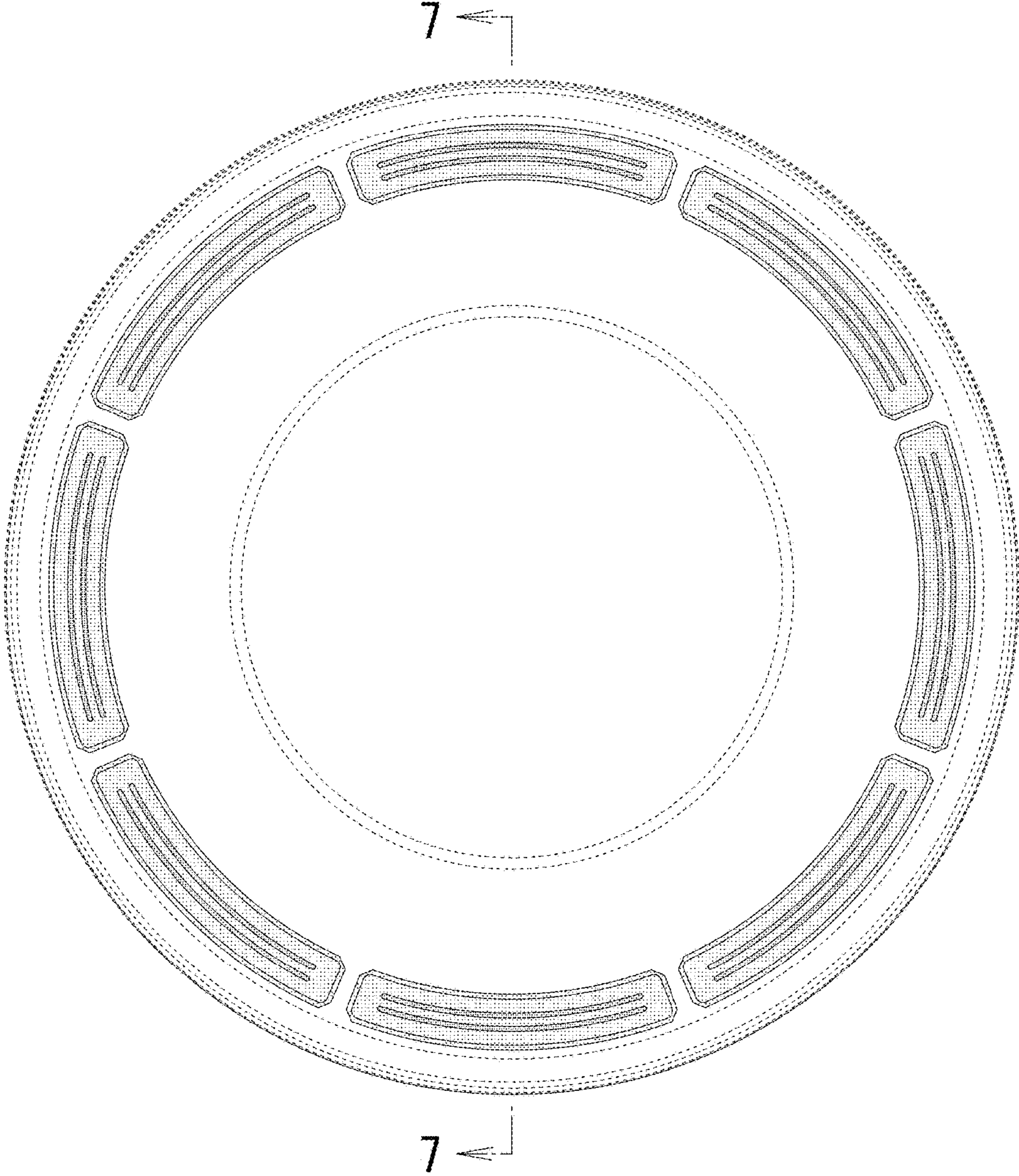

FIG. 2

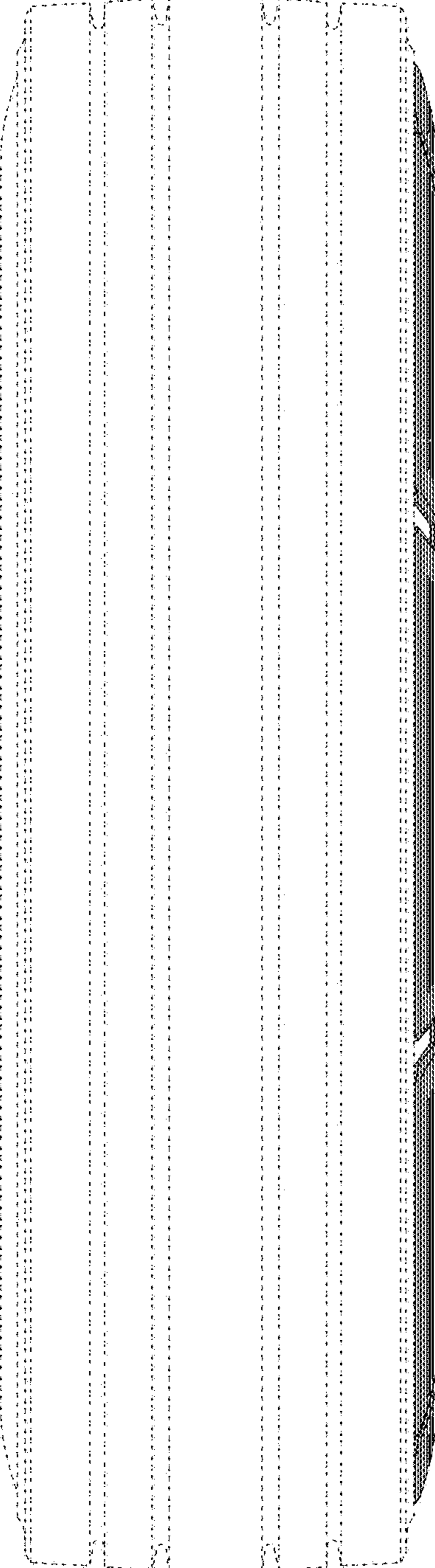

FIG. 3

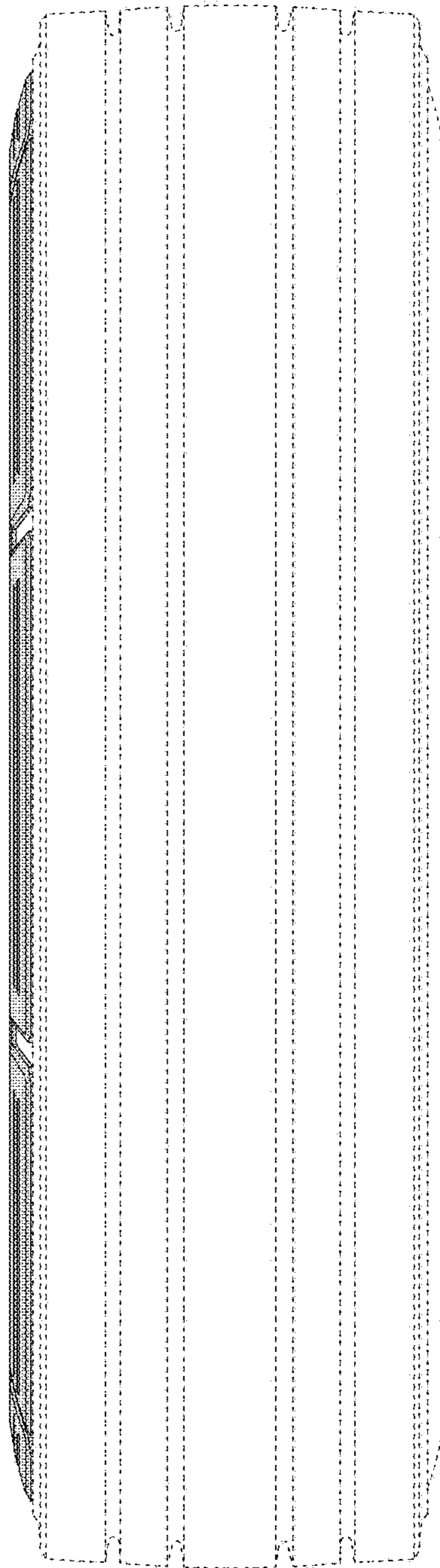

FIG. 4

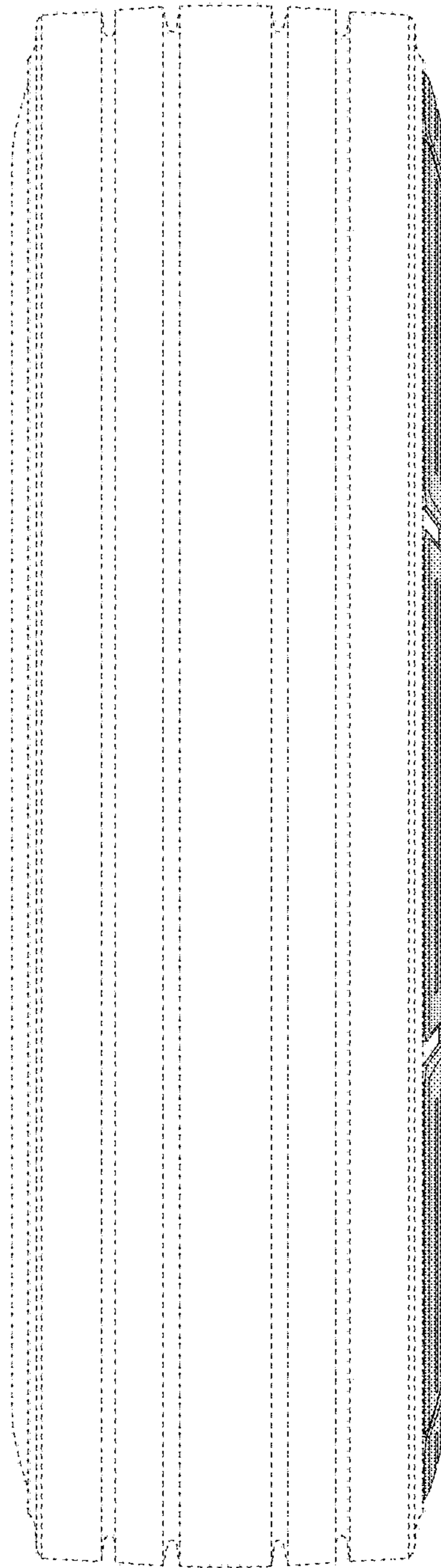

FIG.5

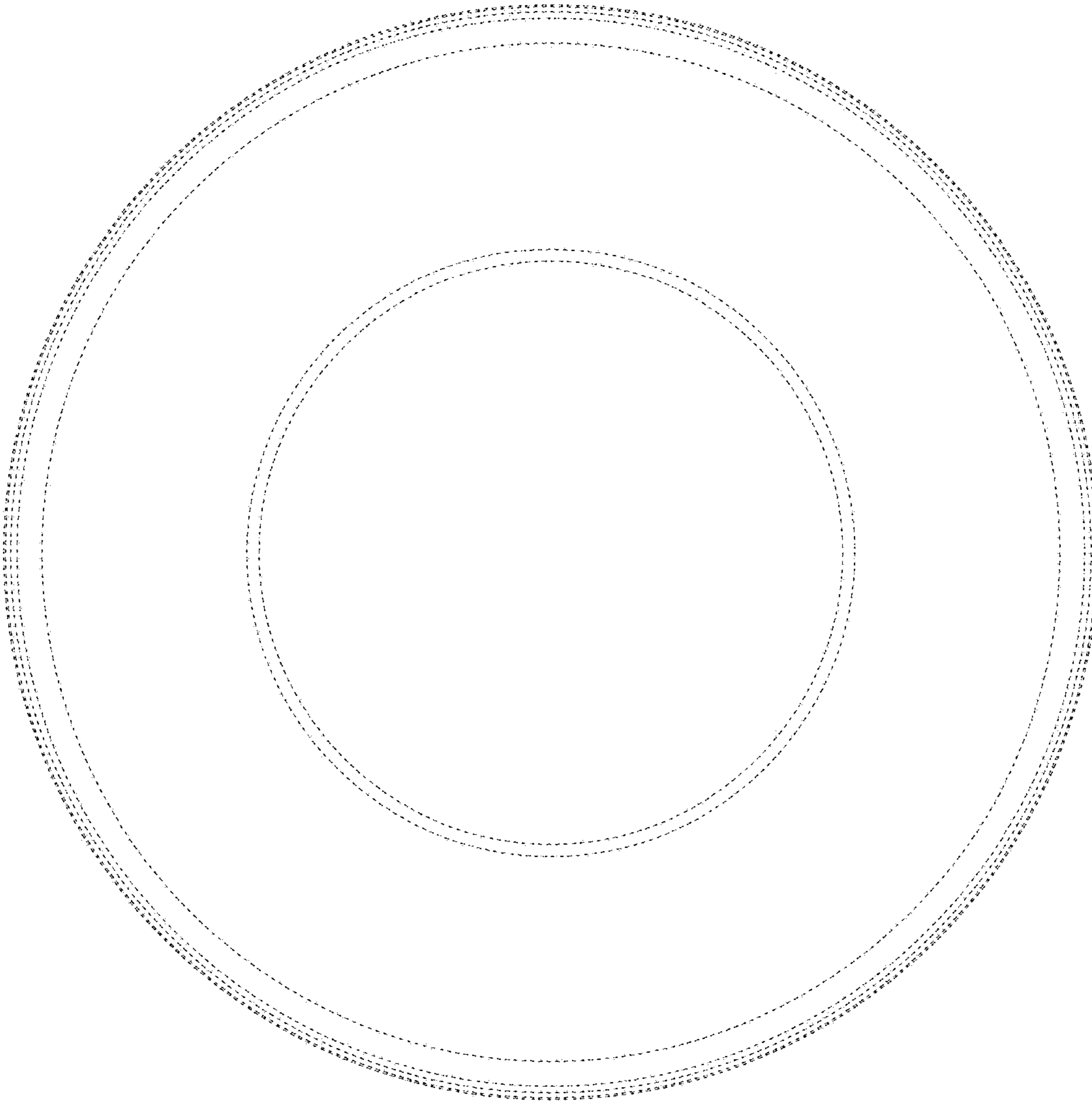

FIG. 6

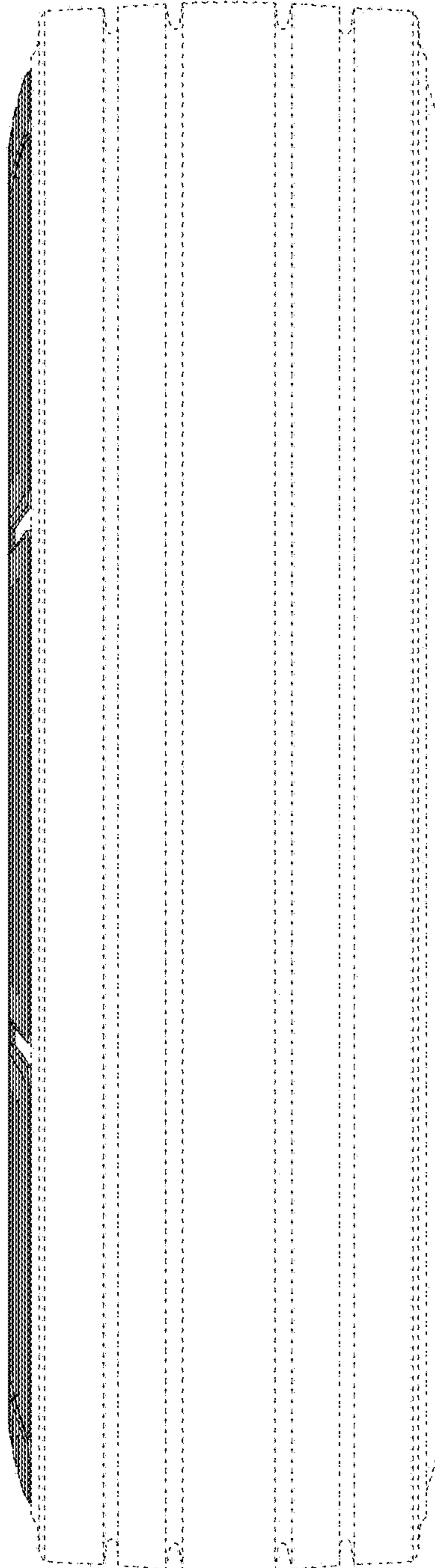



FIG. 7

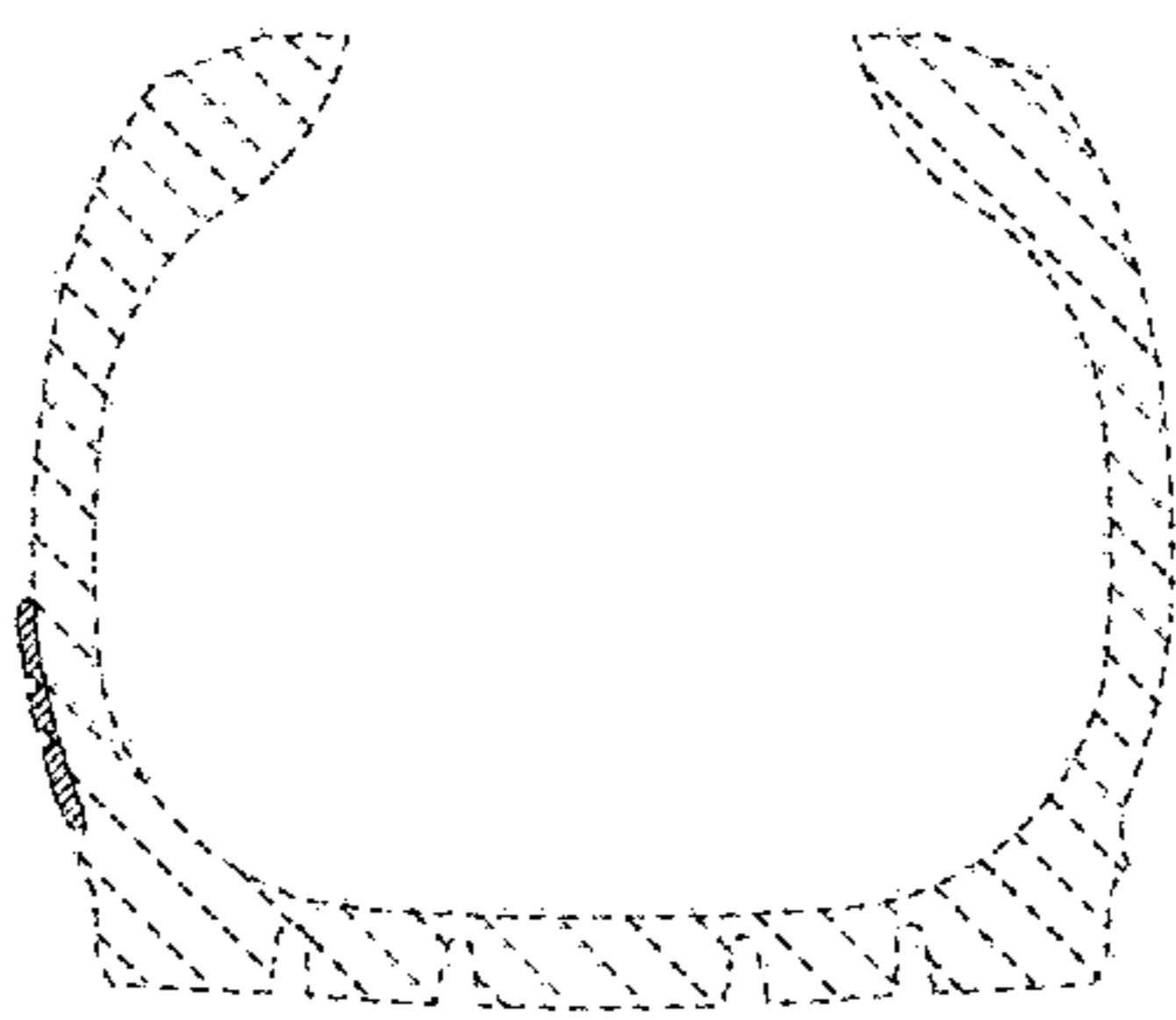
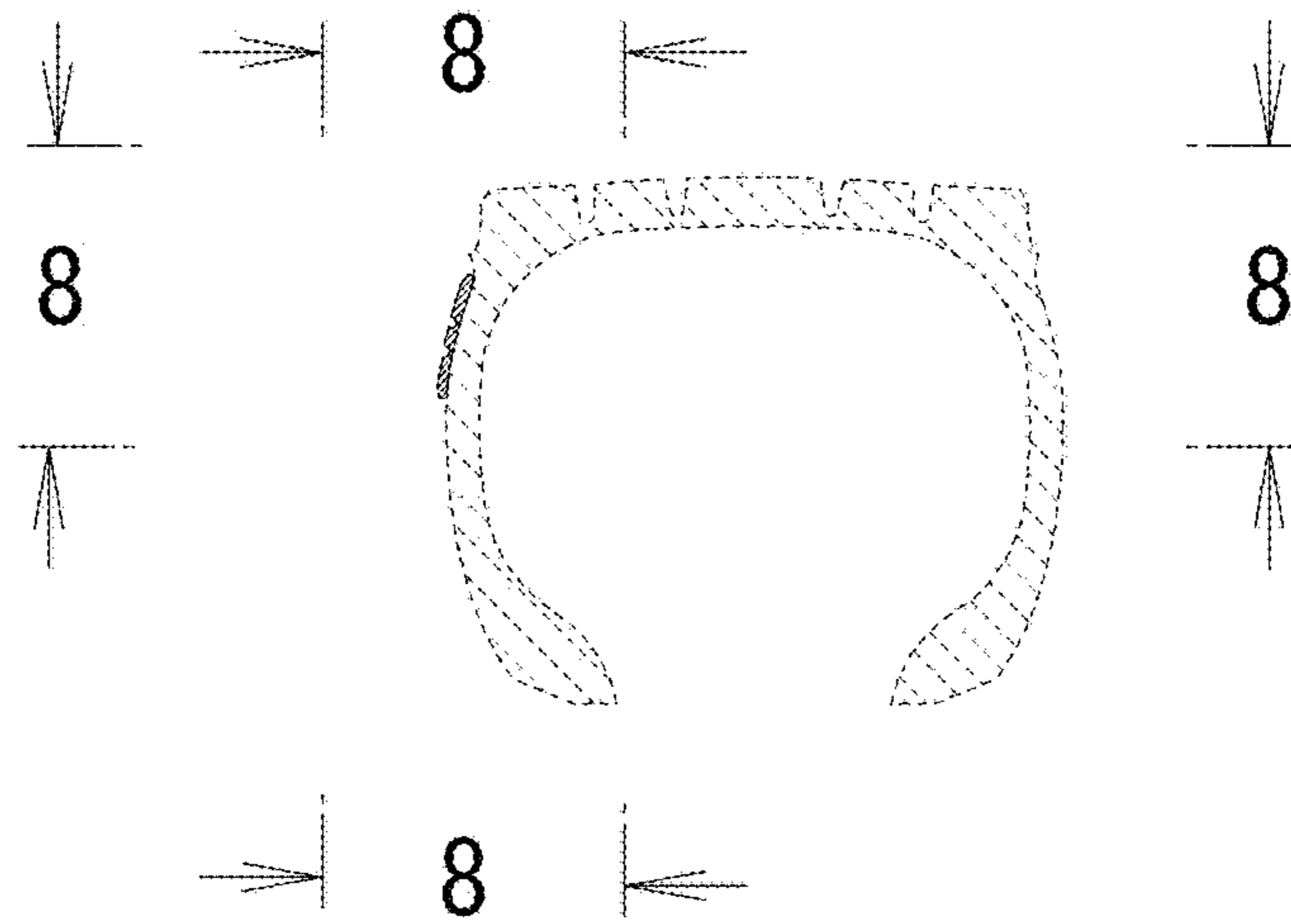

FIG. 8

