



US00D853804S

(12) **United States Design Patent**
Evans et al.

(10) **Patent No.:** **US D853,804 S**
(45) **Date of Patent:** **** Jul. 16, 2019**

(54) **ICE CREAM SCOOP**

(71) Applicant: **JOSEPH JOSEPH, LTD.**, London
(GB)

(72) Inventors: **David Evans**, Cambridge (GB); **Ashley May**, Cambridge (GB)

(73) Assignee: **JOSEPH JOSEPH LTD.**, London
(GB)

(**) Term: **15 Years**

(21) Appl. No.: **29/633,999**

(22) Filed: **Jan. 17, 2018**

(30) **Foreign Application Priority Data**

Jul. 17, 2017 (EM) 004107217-0015

(51) **LOC (11) Cl.** **07-99**

(52) **U.S. Cl.**
USPC **D7/681**

(58) **Field of Classification Search**
USPC D7/680-696, 642-664, 393-395, 401.2
CPC A47J 43/282; A21C 5/00; A23G 9/287;
A23G 9/283; A47F 13/08; F24B 15/06;
A23P 1/105
See application file for complete search history.

(56) **References Cited**

U.S. PATENT DOCUMENTS

2,351,568 A * 6/1944 Wheaton C25D 1/00
205/73
6,313,451 B1 * 11/2001 Vidmar H05B 6/6494
219/730

D475,899 S * 6/2003 Ming-Shiue D7/681
D487,863 S * 3/2004 Bitonto D7/681
D501,373 S * 2/2005 Allen, Jr. D7/681
D501,374 S * 2/2005 Crowley D7/681
D508,386 S * 8/2005 Lee D7/681
D513,946 S * 1/2006 Lion D7/681

* cited by examiner

Primary Examiner — Terry A Wallace

(74) *Attorney, Agent, or Firm* — Millen, White, Zelano & Branigan, PC

(57) **CLAIM**

The ornamental design for an ice cream scoop, as shown and described.

DESCRIPTION

FIG. 1 is a back view of the ice cream scoop showing my new design.
FIG. 2 is a bottom view thereof.
FIG. 3 is a front view thereof.
FIG. 4 is a front perspective view thereof.
FIG. 5 is a side view thereof.
FIG. 6 is another side view thereof; and,
FIG. 7 is a top view thereof.

1 Claim, 7 Drawing Sheets

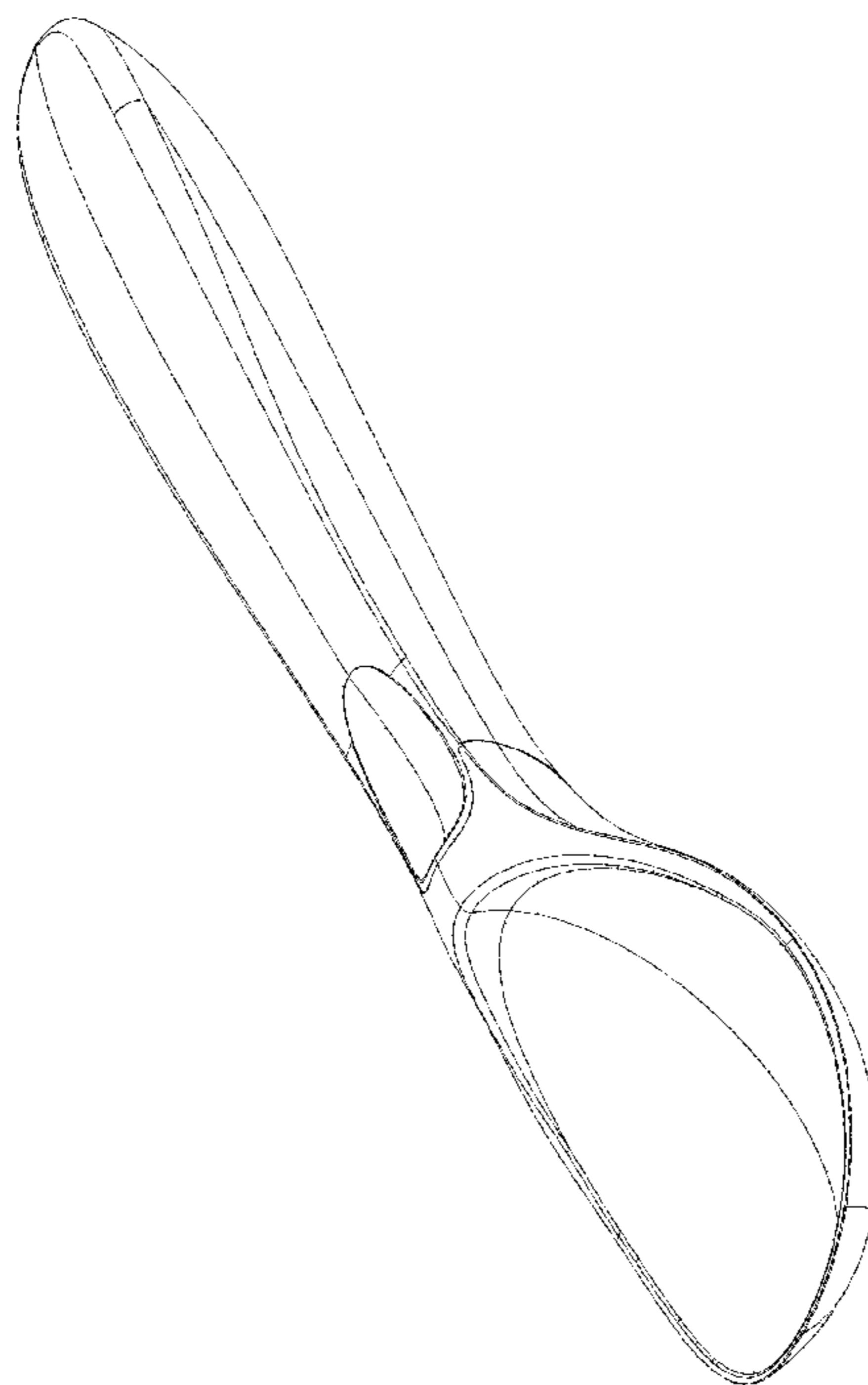

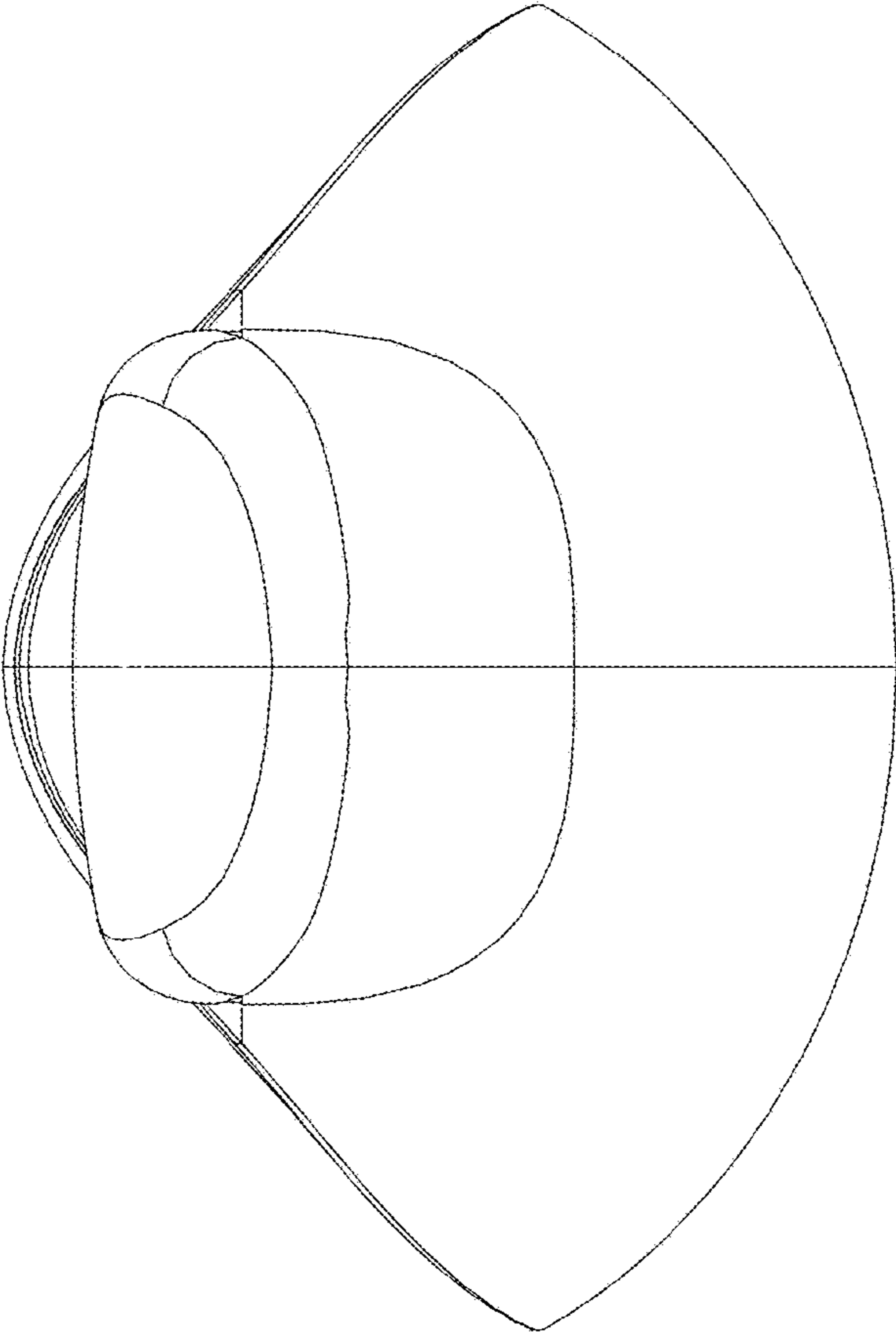

FIG 1

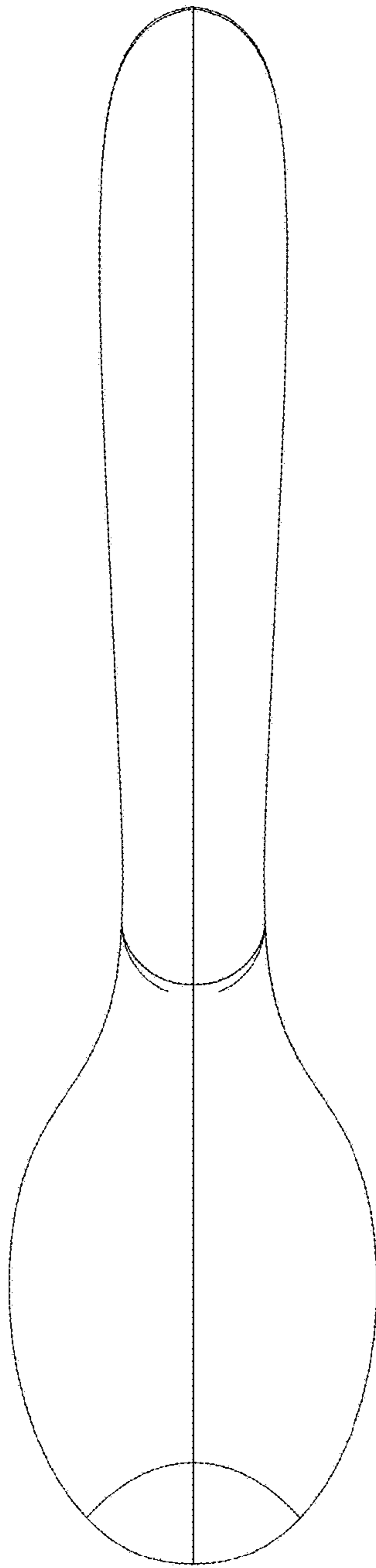

FIG 2

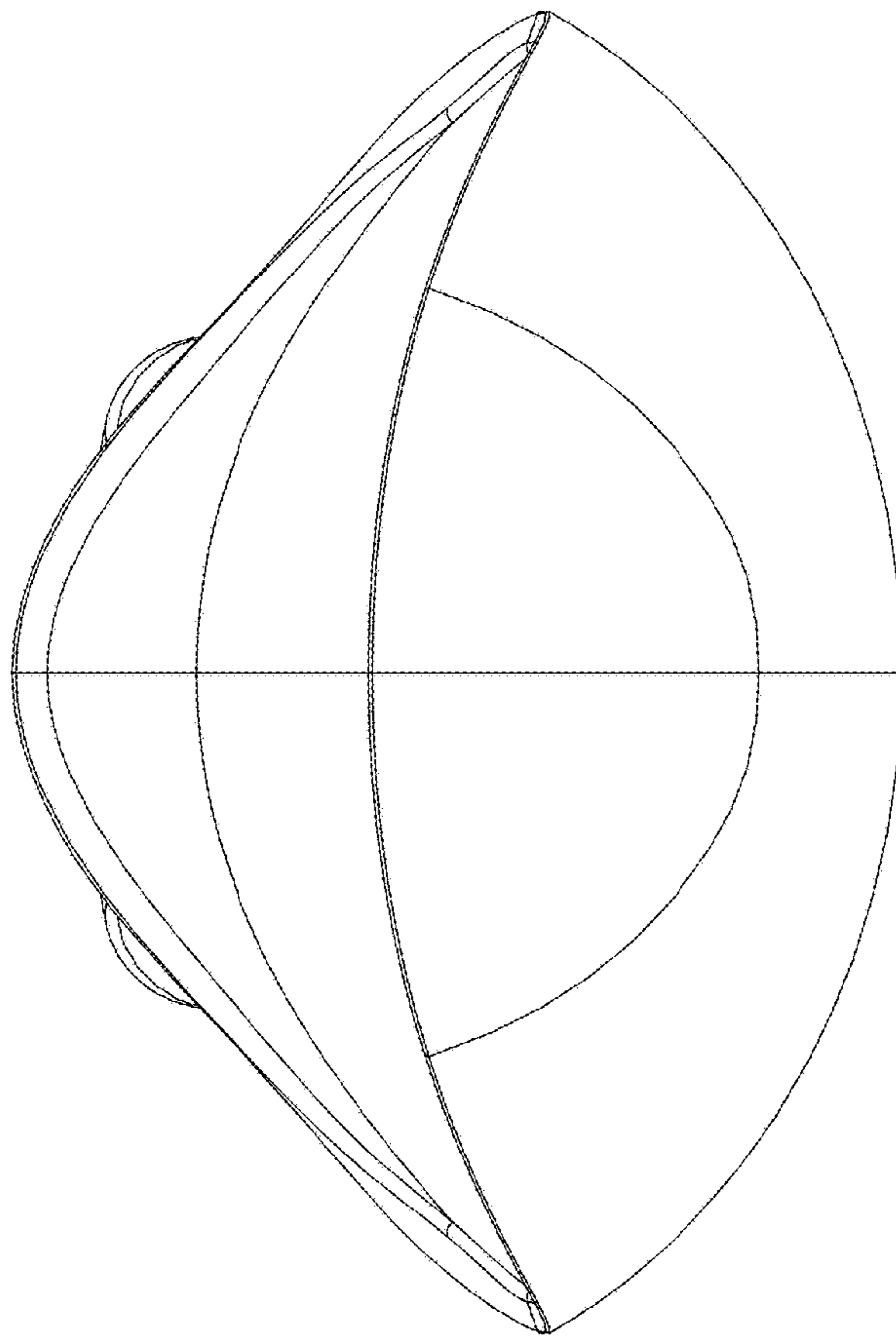

FIG 3

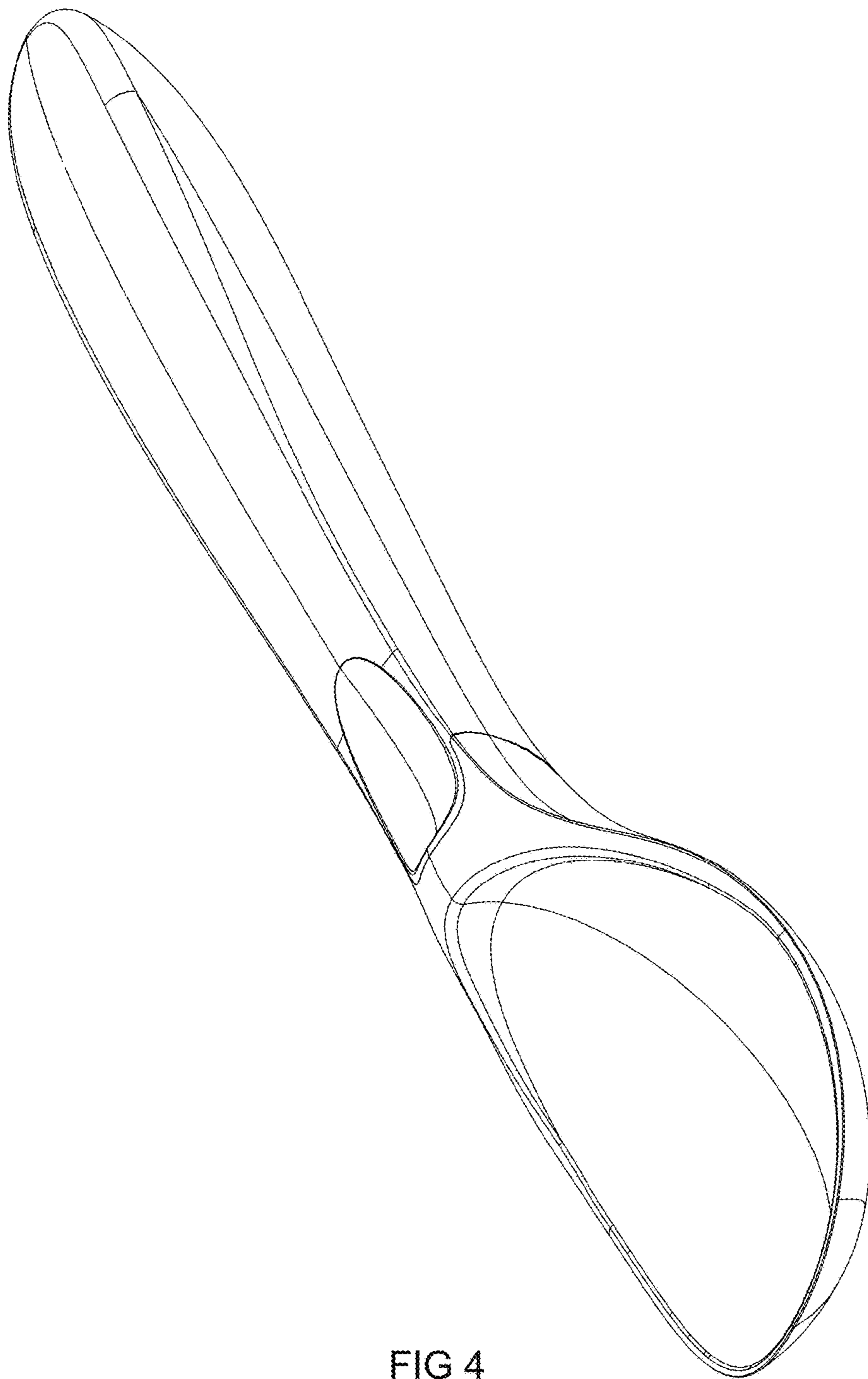

FIG 4

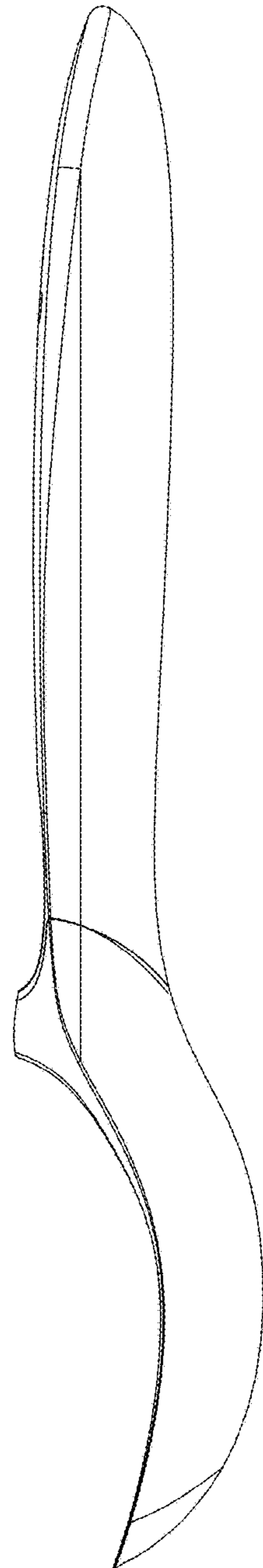

FIG 5

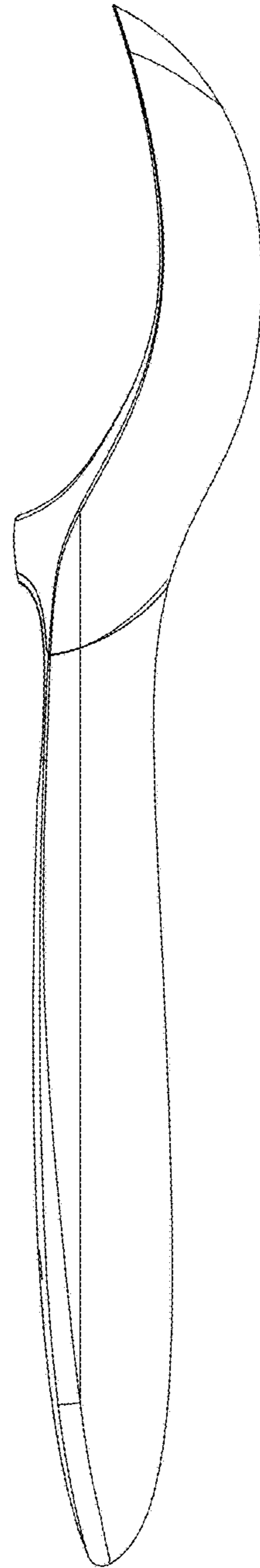

FIG 6

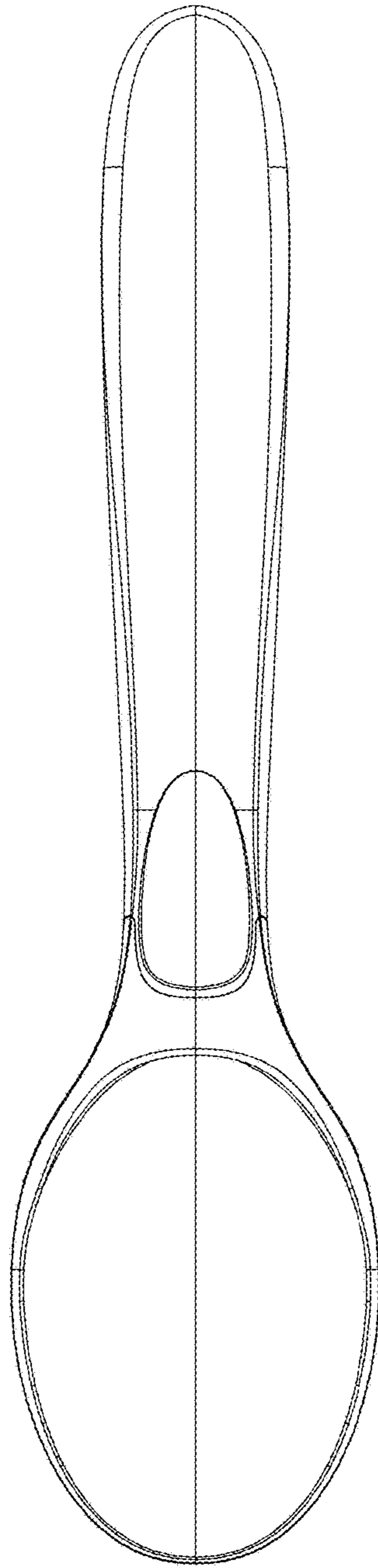

FIG 7