



US00D853759S

(12) **United States Design Patent**
Moore

(10) **Patent No.:** **US D853,759 S**
(45) **Date of Patent:** **** Jul. 16, 2019**

(54) **VARIABLE HEIGHT DESK**
(71) Applicant: **URBAN PLOUGH LLC**, Phoenix, AZ (US)
(72) Inventor: **Matthew Moore**, Phoenix, AZ (US)
(73) Assignee: **Urban Plough, LLC**, Phoenix, AZ (US)
(**) Term: **15 Years**

9,980,559 B2 * 5/2018 Randolph A47B 21/04
2006/0185564 A1 * 8/2006 Stengel A47B 21/0073
108/50.01
2006/0230992 A1 * 10/2006 Newhouse A47B 9/18
108/147
2008/0018211 A1 * 1/2008 Dye A47B 9/02
312/223.3
2008/0284292 A1 * 11/2008 Castelluccio A47B 85/08
312/107
2008/0284293 A1 * 11/2008 Martin A47B 21/00
312/196
2009/0094913 A1 * 4/2009 Singh E04B 2/7422
52/239

(21) Appl. No.: **29/627,447**

* cited by examiner

(22) Filed: **Nov. 27, 2017**

Primary Examiner — Mary Ann Calabrese

(51) **LOC (11) Cl.** **06-03**

Assistant Examiner — Catherine Ho

(52) **U.S. Cl.**
USPC **D6/644**

(74) *Attorney, Agent, or Firm* — Lewis Roca Rothgerber
Christie LLP

(58) **Field of Classification Search**
USPC D6/640, 641, 642, 643, 643.1, 644, 648,
D6/648.1, 648.3, 648.4, 649, 650, 651,
D6/652, 655, 655.1, 655.11, 656, 668,
D6/685, 688.11, 688.21, 688.27, 690,
D6/695, 698, 696.1, 700, 709.22
CPC A47B 9/00; A47B 9/04; A47B 9/06; A47B
3/08; A47B 21/00; A47B 21/02; A47B
21/06; A47B 21/007; A47B 21/0314;
A47B 2009/185; A47B 2200/0013; A47B
2200/0026; A47B 2200/0085; A47B
2200/0087

(57) **CLAIM**

The ornamental design for a variable height desk, as shown and described.

See application file for complete search history.

DESCRIPTION

FIG. 1 is a perspective view of a variable height desk in a lowered position;
FIG. 2 is a front view of the variable height desk;
FIG. 3 is a rear view of the variable height desk;
FIG. 4 is a left-side view of the variable height desk;
FIG. 5 is a right-side view of the variable height desk;
FIG. 6 is a top view of the variable height desk;
FIG. 7 is a bottom view of the variable height desk; and,
FIG. 8 is a perspective view of the variable height desk in a raised position.

The portions of the figures shown in broken lines form no part of the claimed design.

(56) **References Cited**

U.S. PATENT DOCUMENTS

D208,256 S * 8/1967 Rich 108/60
D285,394 S * 9/1986 Curran D6/655.1
D596,876 S * 7/2009 Oshinomi D6/644
D610,840 S * 3/2010 Kato D6/648

1 Claim, 8 Drawing Sheets

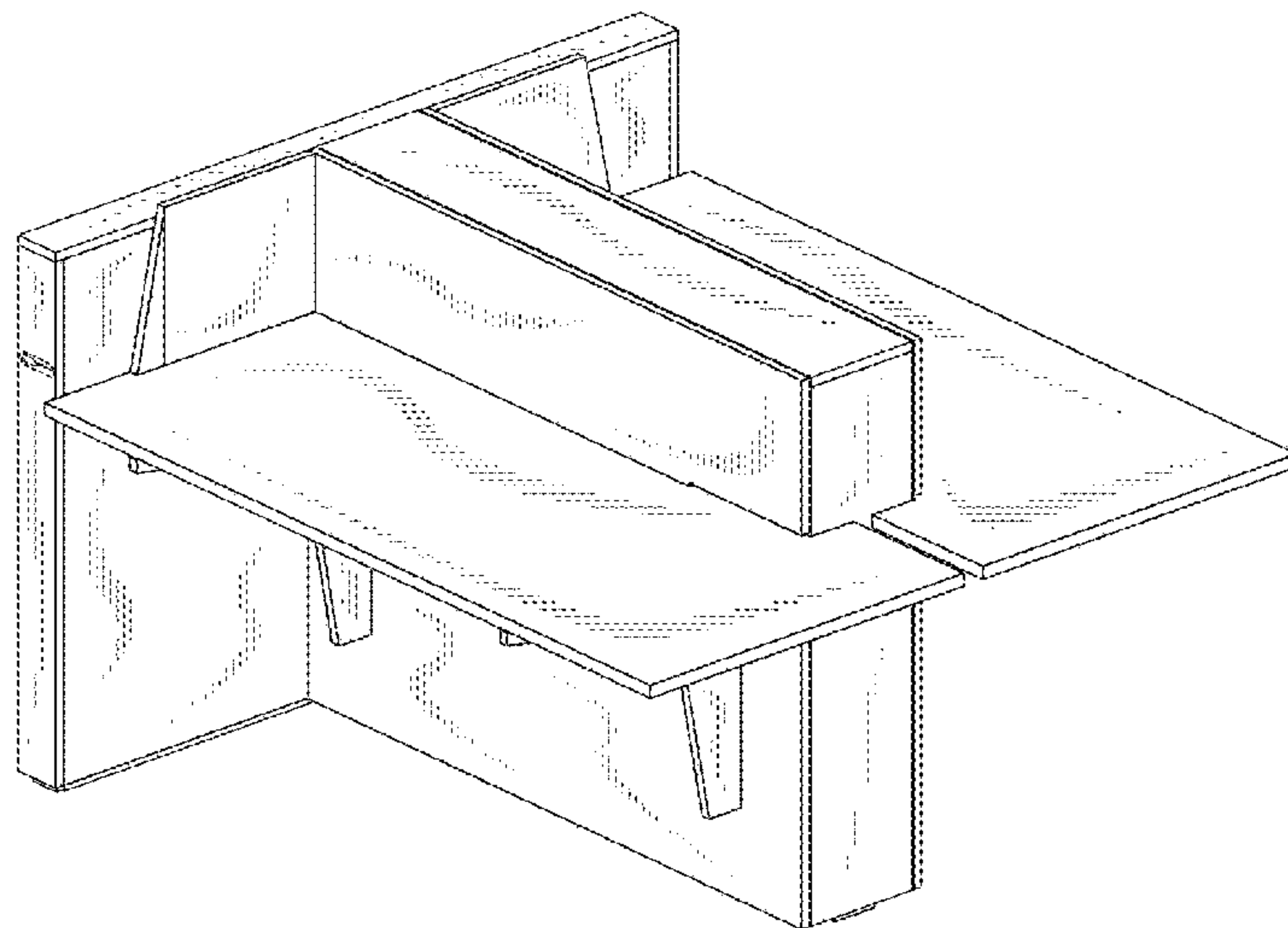

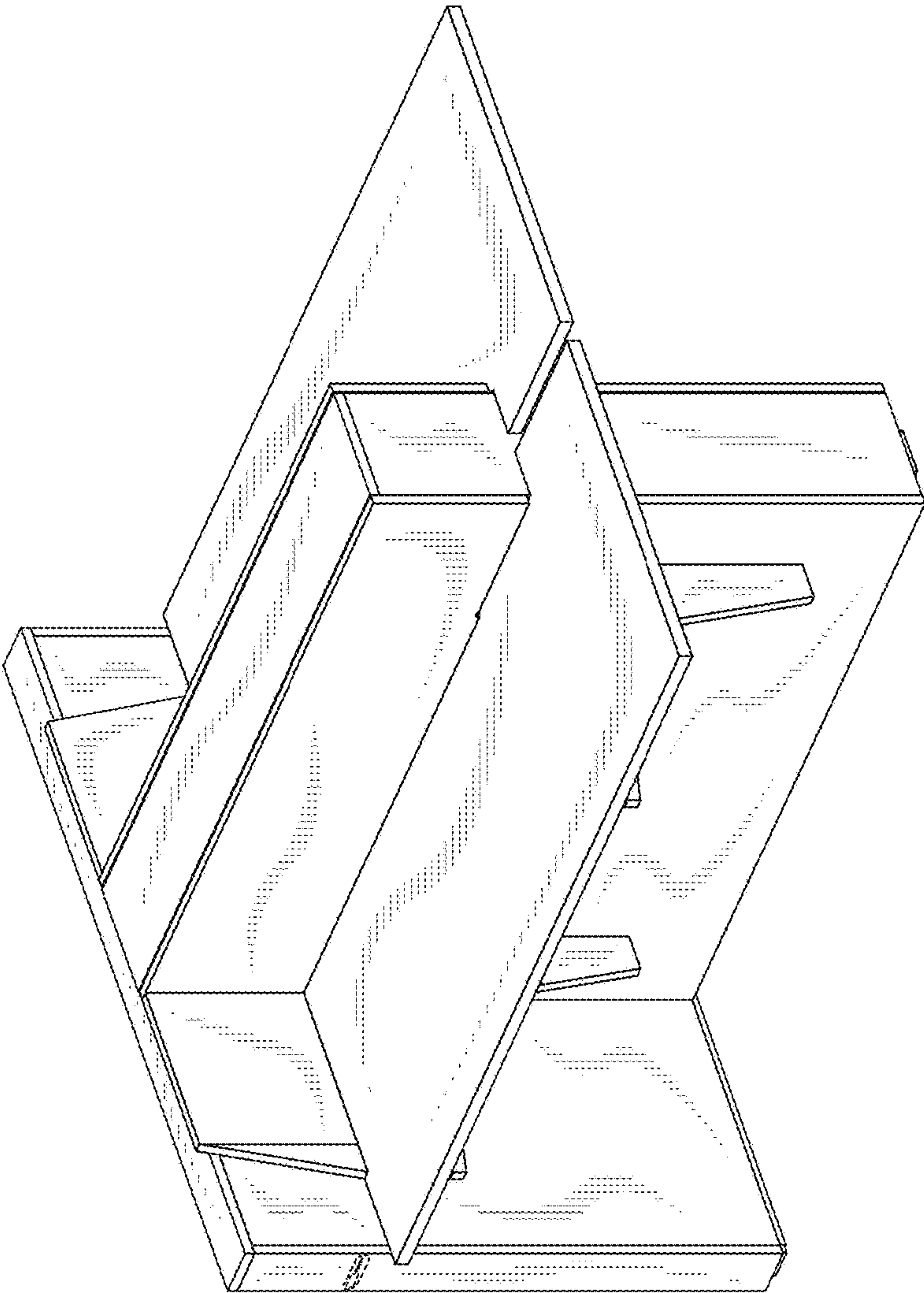

FIG. 1

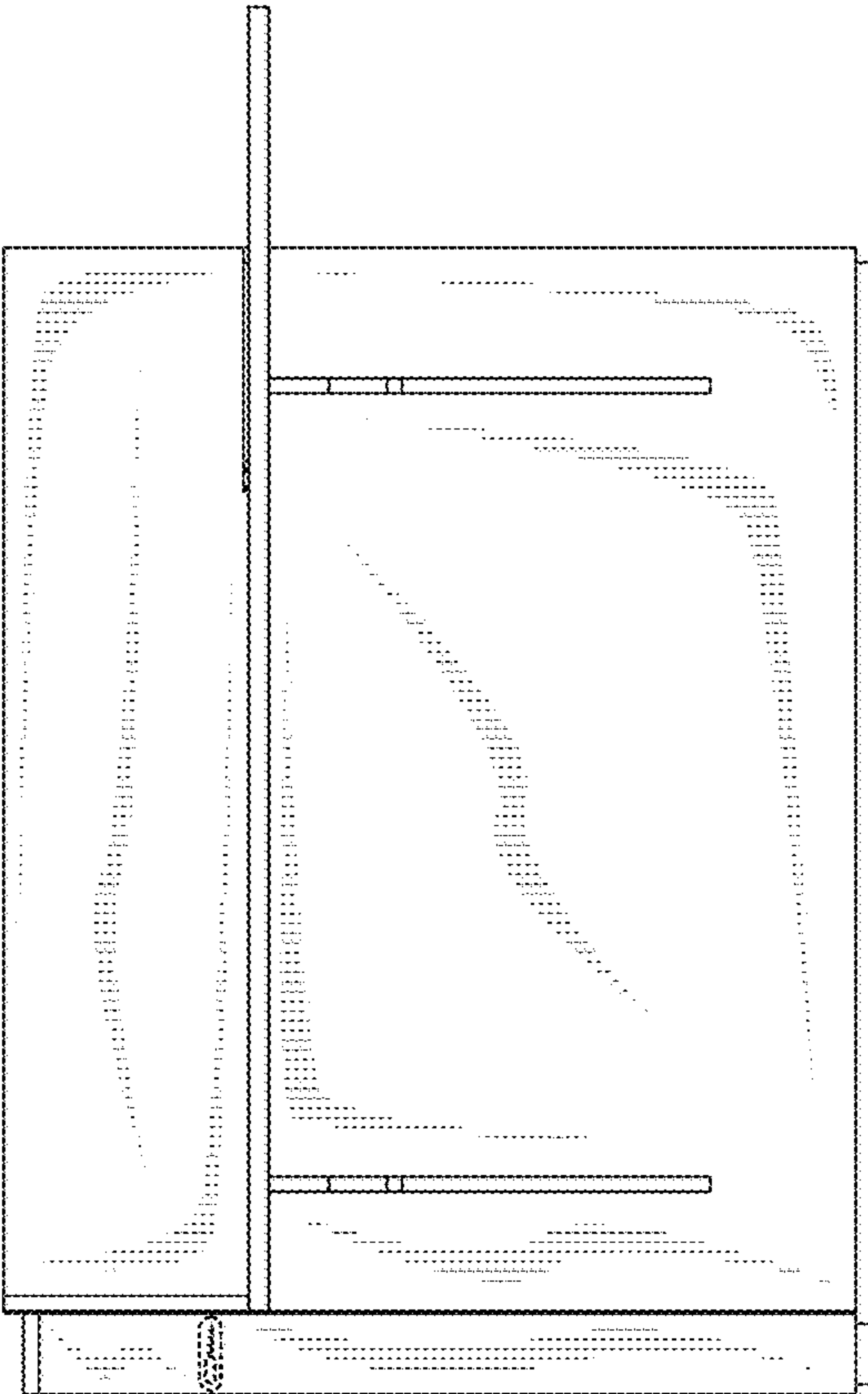

FIG. 2

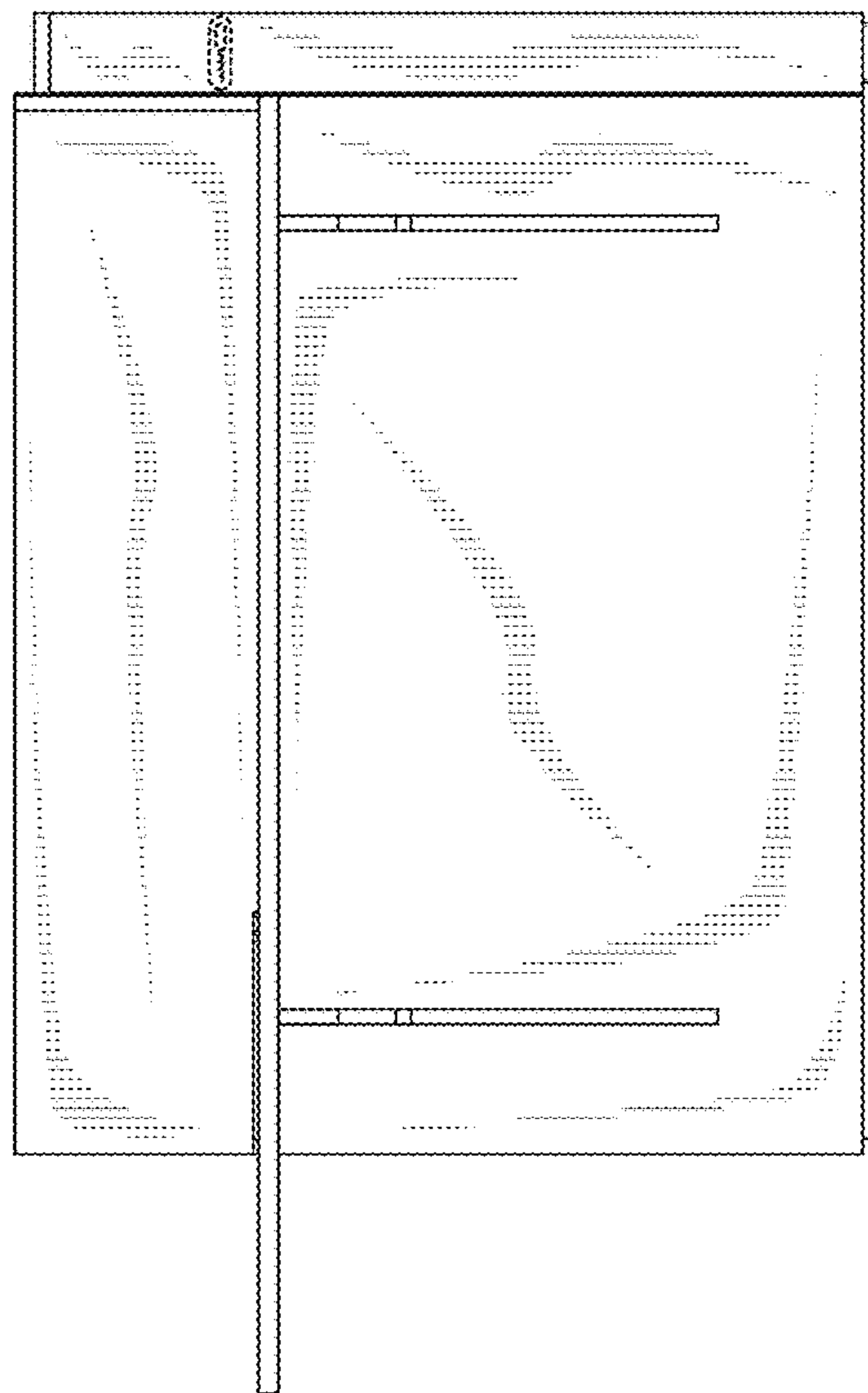

FIG. 3

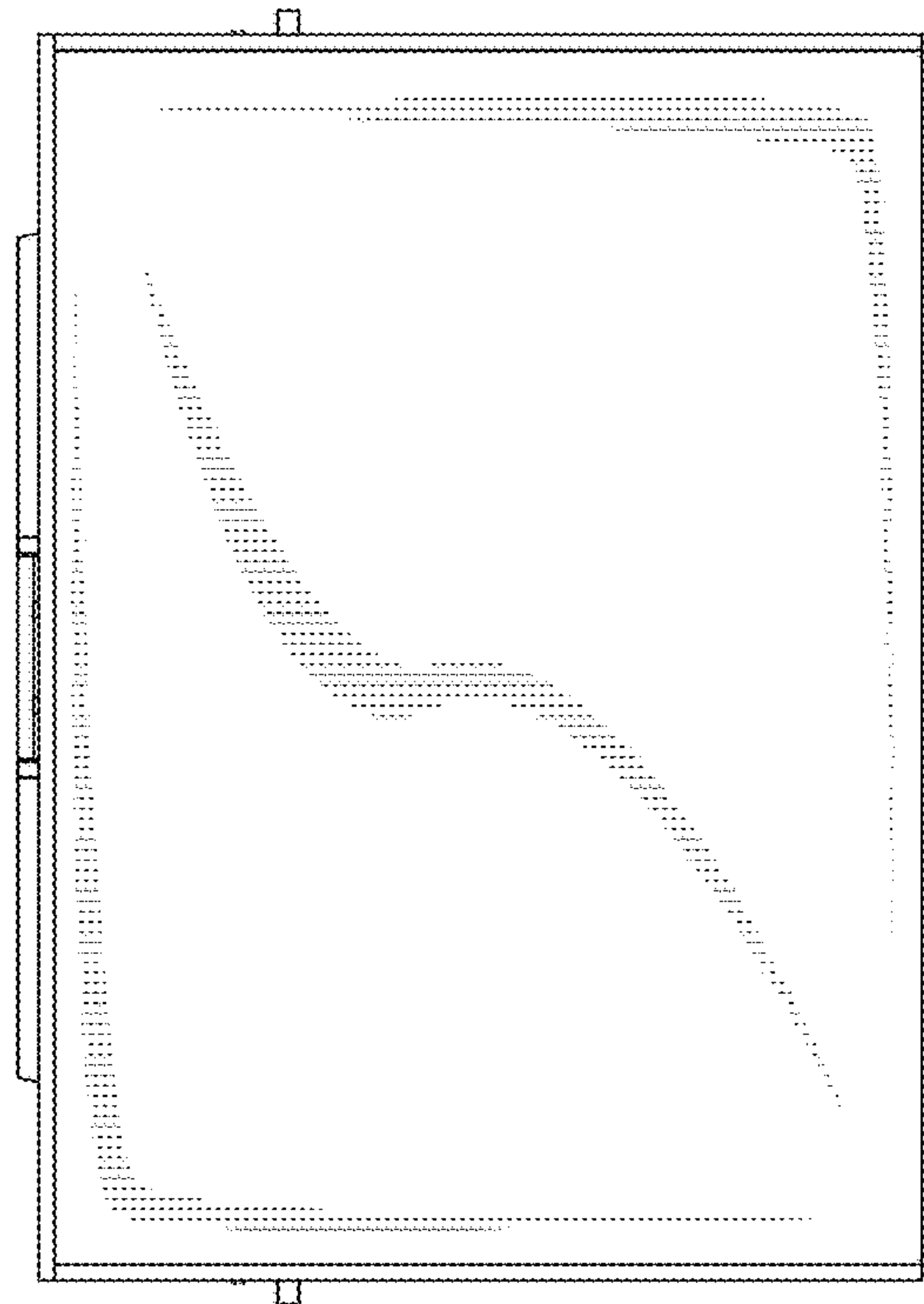

FIG. 4

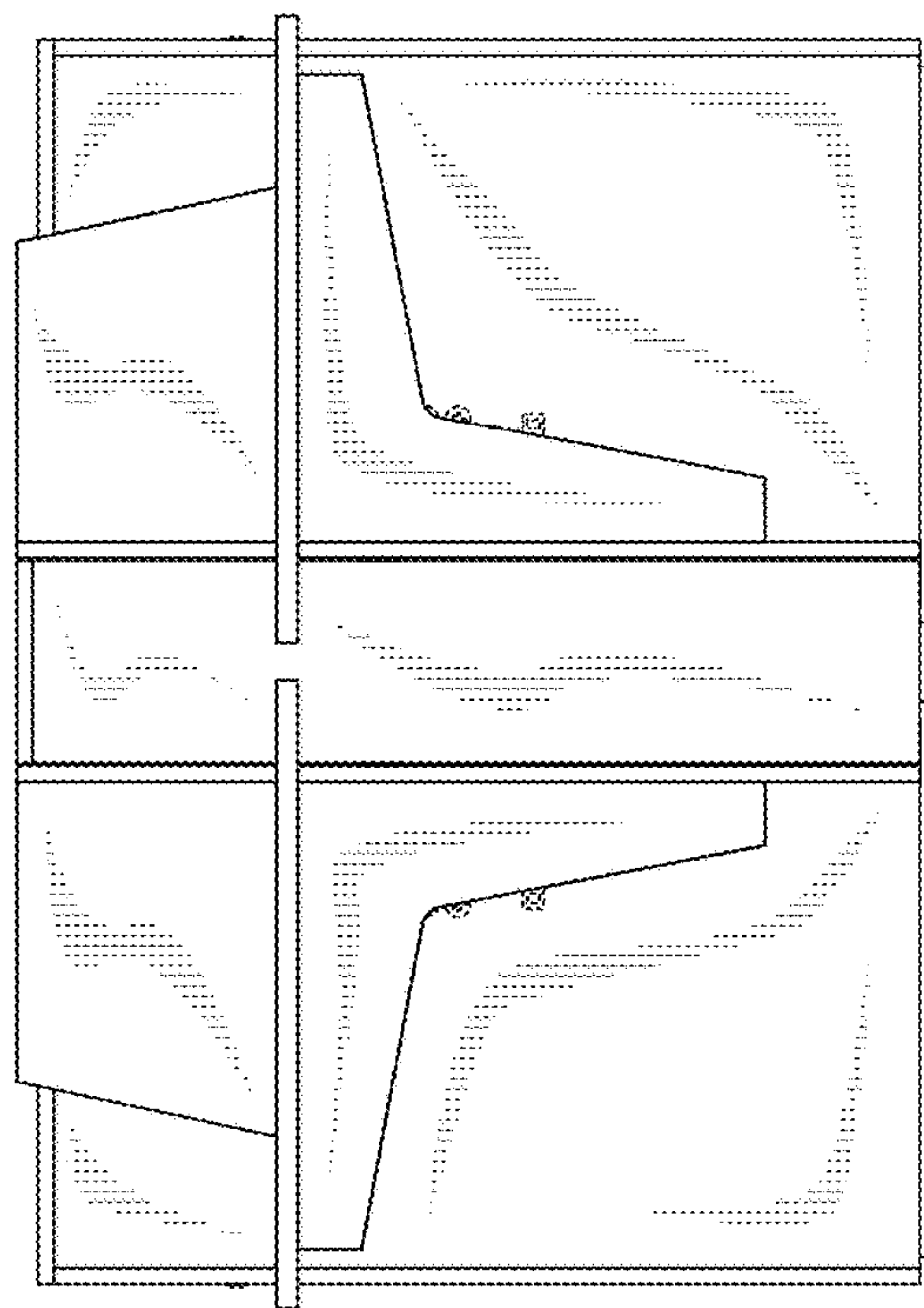

FIG. 5

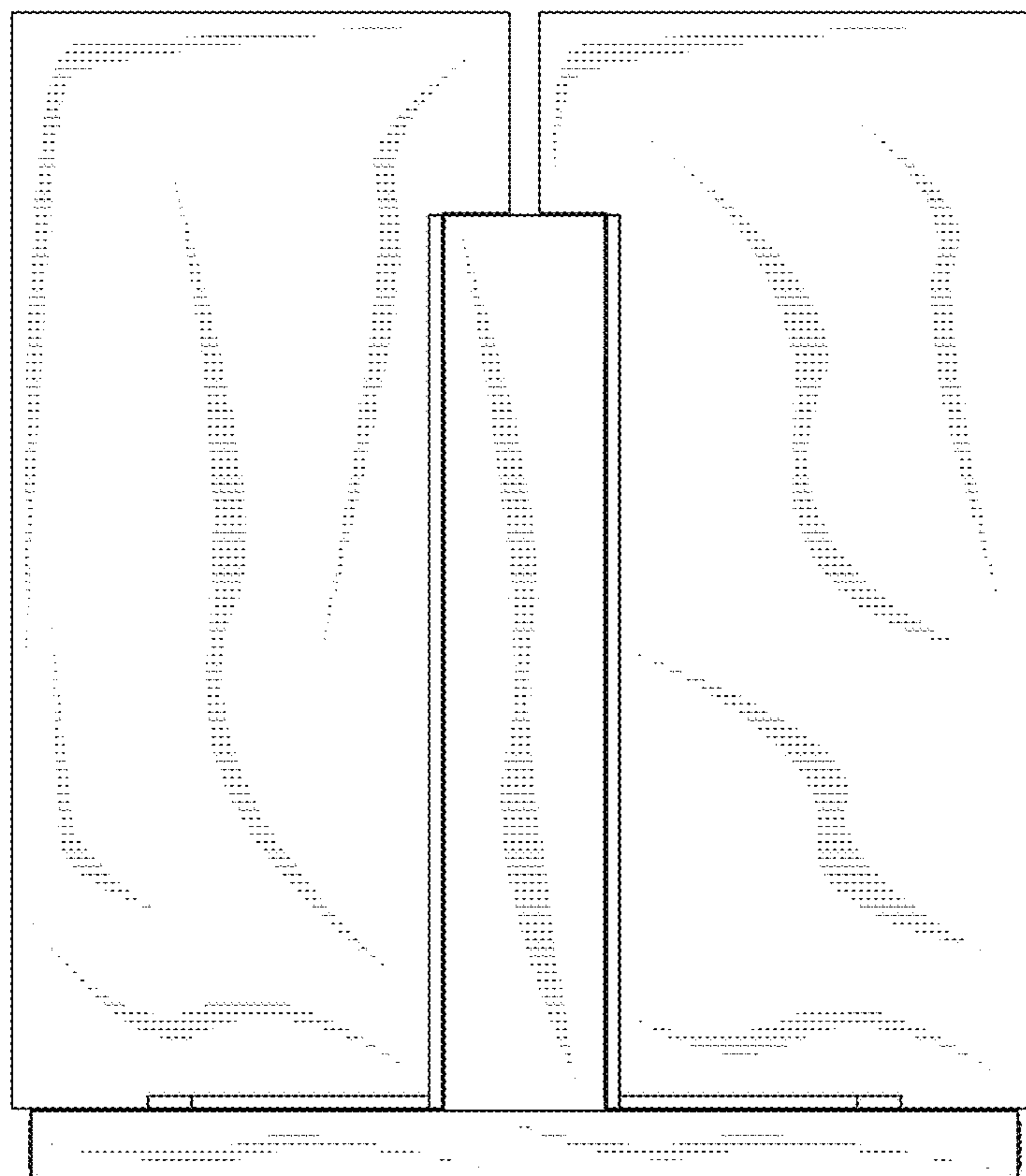

FIG. 6

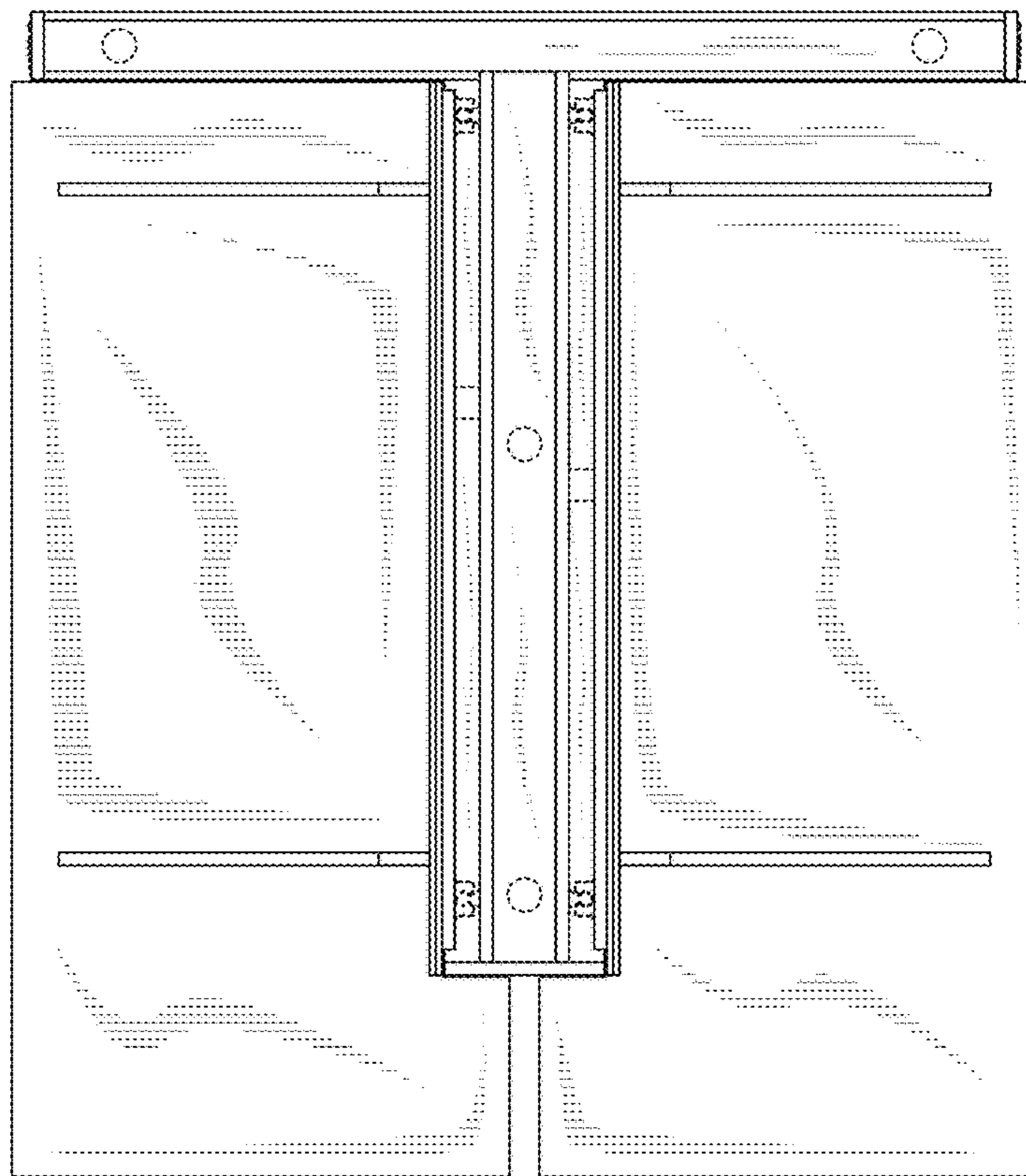

FIG. 7

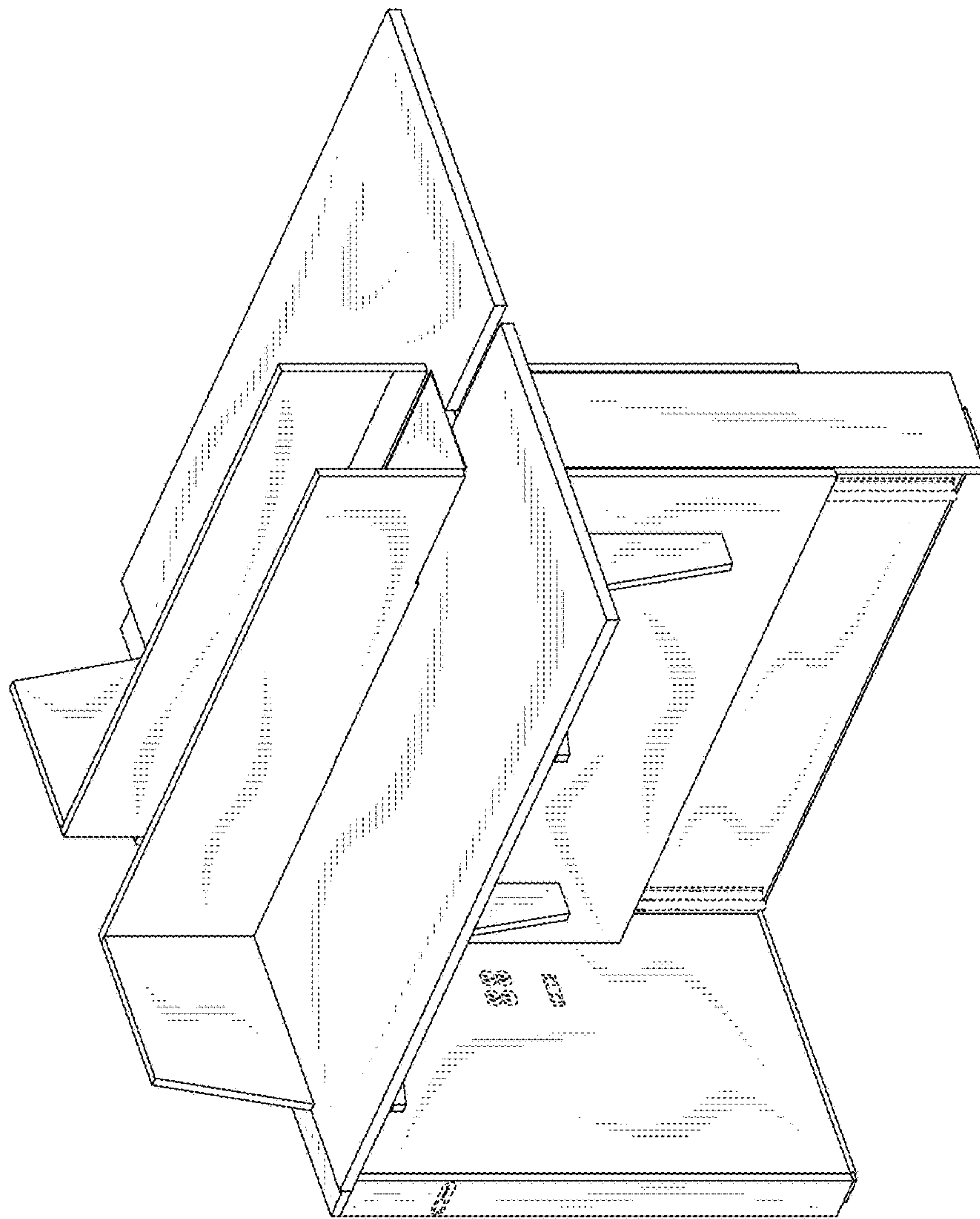

FIG. 8