



US00D853708S

(12) **United States Design Patent** (10) **Patent No.:** **US D853,708 S**  
**Comeaux** (45) **Date of Patent:** **\*\* Jul. 16, 2019**

(54) **SHOE**  
(71) Applicant: **NIKE, Inc.**, Beaverton, OR (US)  
(72) Inventor: **Ashley Comeaux**, Beaverton, OR (US)  
(73) Assignee: **NIKE, Inc.**, Beaverton, OR (US)  
(\*\*) Term: **15 Years**  
(21) Appl. No.: **29/655,087**

D629,186 S 12/2010 Blakeslee  
D636,583 S 4/2011 Petrie  
D636,590 S 4/2011 Miner  
D642,369 S 8/2011 Miner  
D656,723 S 4/2012 Eidson et al.  
D688,039 S 8/2013 Williams, Jr.  
D693,110 S 11/2013 Miner  
D750,881 S \* 3/2016 Hardman ..... D2/972  
D793,711 S \* 8/2017 Hardman ..... D2/973  
D798,575 S 10/2017 Comeaux  
D799,809 S \* 10/2017 Link ..... D2/973  
D808,144 S 1/2018 Kovel et al.

(Continued)

(22) Filed: **Jun. 29, 2018**  
(51) **LOC (11) Cl.** ..... **02-99**  
(52) **U.S. Cl.**  
USPC ..... **D2/972**  
(58) **Field of Classification Search**  
USPC ..... D2/896, 902, 906-908, 946, 947, 969,  
D2/972-974; D5/47, 49, 50, 53, 54, 56,  
D5/60  
CPC ... A43B 13/181; A43B 13/141; A43B 13/186;  
A43B 13/188; A43B 23/00; A43B 23/02;  
A43B 5/00; A43B 23/26; A43B 1/04;  
A43B 11/14; A43B 7/00; A43B 3/12;  
A43C 3/00; A43C 5/00; A43C 7/00;  
A43C 11/004  
See application file for complete search history.

**OTHER PUBLICATIONS**

Nike Unveils Shoes Designed to Run a Sub-2-Hour Marathon [online], [retrieved Jun. 22, 2018] retrieved from internet <URL: [http://running.competitor.com/2017/03/news/nike-unveils-shoes-designed-to-run-a-sub-2-hour-marathon\\_162689/](http://running.competitor.com/2017/03/news/nike-unveils-shoes-designed-to-run-a-sub-2-hour-marathon_162689/)>; 7 color sheets, Dated Mar. 7, 2017.

(Continued)

*Primary Examiner* — Dominic V Simone  
(74) *Attorney, Agent, or Firm* — Banner & Witcoff, Ltd.

(57) **CLAIM**

The ornamental design for a shoe, as shown and described.

**DESCRIPTION**

FIG. 1 is a side view of a shoe showing my new design; FIG. 2 is a front perspective view thereof; FIG. 3 is a front view thereof; FIG. 4 is an opposite side view thereof; FIG. 5 is a rear perspective view thereof; and, FIG. 6 is a top view thereof. The curved oblique shade lines represent transparent or translucent material. The broken lines depicting the remainder of the shoe show features that form no part of the claimed design.

**1 Claim, 6 Drawing Sheets**

(56) **References Cited**  
U.S. PATENT DOCUMENTS  
D300,981 S 5/1989 Gerber et al.  
D300,983 S 5/1989 Le  
D302,486 S 8/1989 Brown et al.  
D303,452 S 9/1989 Swett  
D304,388 S 11/1989 Brown  
D304,389 S 11/1989 Miller  
D330,451 S 10/1992 Hatfield  
D339,446 S 9/1993 Teague  
D517,297 S 3/2006 Jones et al.  
D523,626 S 6/2006 Mueller  
D595,040 S 6/2009 Mochen

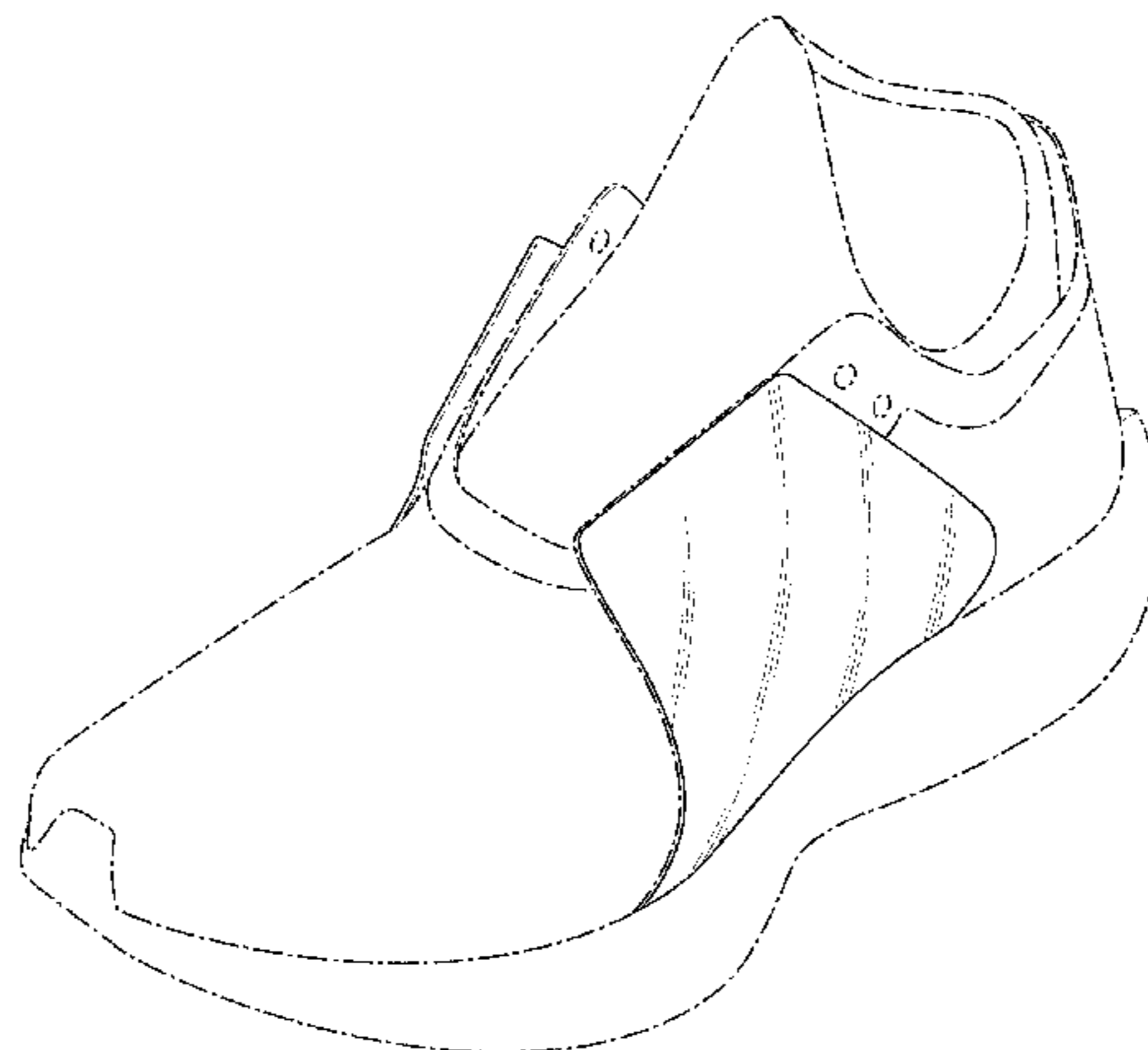

(56)

**References Cited**

U.S. PATENT DOCUMENTS

D809,763 S      2/2018   Martin  
D821,729 S      7/2018   Durflinger

OTHER PUBLICATIONS

The Nike Future Racer Will Be Making Its Debut in 2018 [online], [retrieved Jun. 22, 2018] retrieved from internet <URL: <https://www.kicksonfire.com/nike-future-racer/>>; 2 color sheets, Dated Jan. 9, 2018.

Nike Is Restocking the Original Zoom Fly SP [online], [retrieved Jun. 22, 2018] retrieved from internet <URL: <https://sneakernews.com/2018/04/17/nike-zoom-fly-sp-breaking-2-restock-info/>>; 2 color sheets, Dated Apr. 17, 2018.

Nike Footwear Catalog, 1985 Spring Footwear, p. 29, published date unknown, but prior to the filing date of the present application, NIKE, Inc., USA.

Nike Footwear Catalog, 1993 Fall Footwear, p. 80, published Dec. 1992, NIKE, Inc., USA.

Nike Footwear Catalog, 1999 Holiday Jordan Footwear Catalog, p. 10, published Mar. 1999, NIKE, Inc., USA.

Nike Footwear Catalog, 2000 Spring Footwear 2, p. 26, published Jul. 1999, NIKE, Inc., USA.

Nike Footwear Catalog, 2000 Fall Footwear Blue Cover, p. 5, published Nov. 1999, NIKE, Inc., USA.

Nike Footwear Catalog, 2002 Spring Footwear, p. 39, published Jun. 2001, NIKE, Inc., USA.

Nike Footwear Catalog, 2011 Fall Men's Performance Footwear, p. 7, published Nov. 2010, NIKE, Inc., USA.

Nike Footwear Catalog, 2012 Spring Core Footwear, p. 40, published May 2011, NIKE, Inc., USA.

Nike Footwear Catalog, 2013 Fall Mens Performance Footwear, p. 24, published Nov. 2012, NIKE, Inc., USA.

Nike Footwear Catalog, 2017 Spring City Specialty Footwear Energy NA, p. 13, published May 2016, NIKE, Inc., USA.

Nike Footwear Catalog, 2018 Holiday Men's Training, p. 75, published date unknown, but prior to the filing date of the present application, NIKE, Inc., USA.

\* cited by examiner

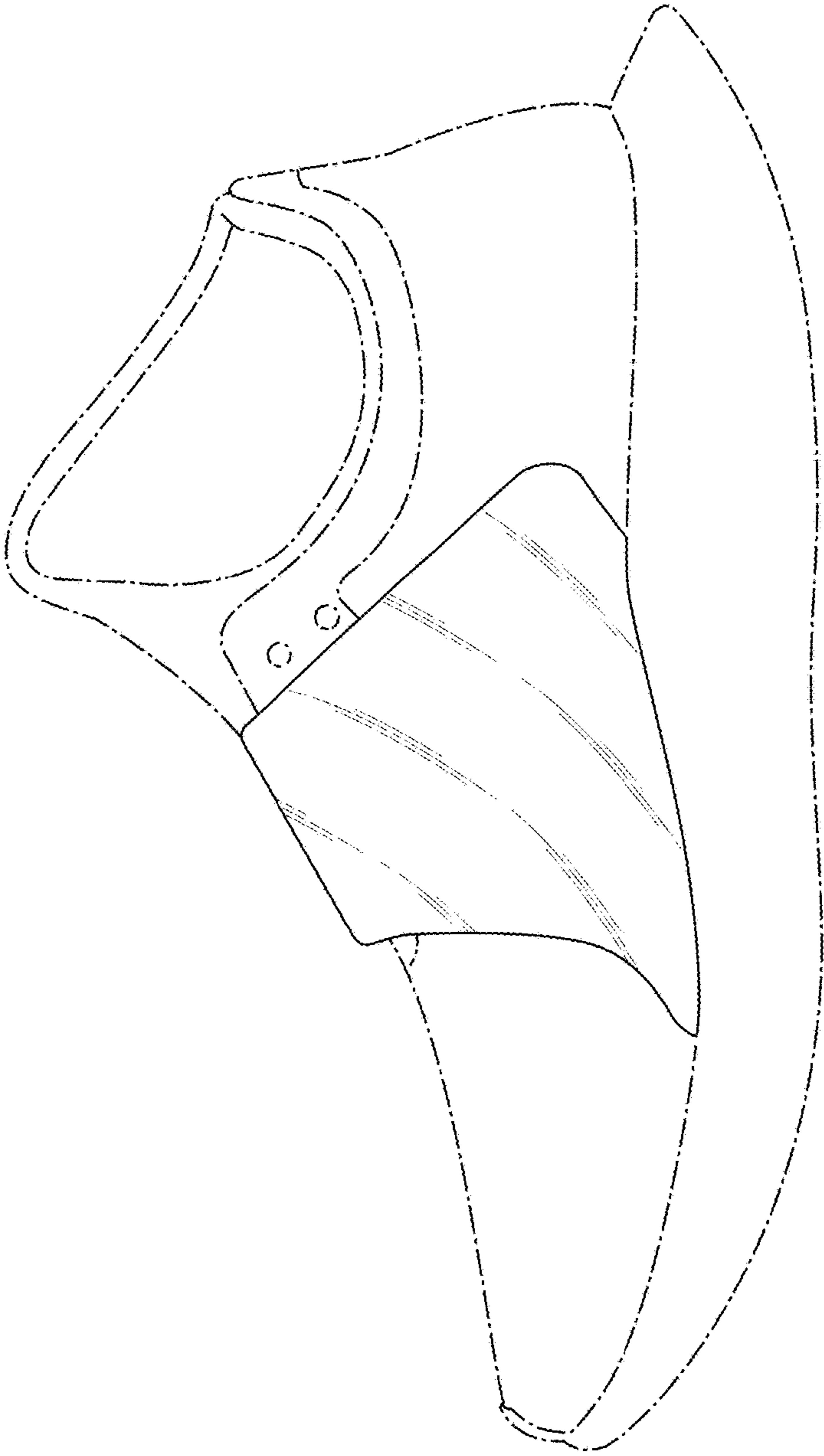

FIG. 1

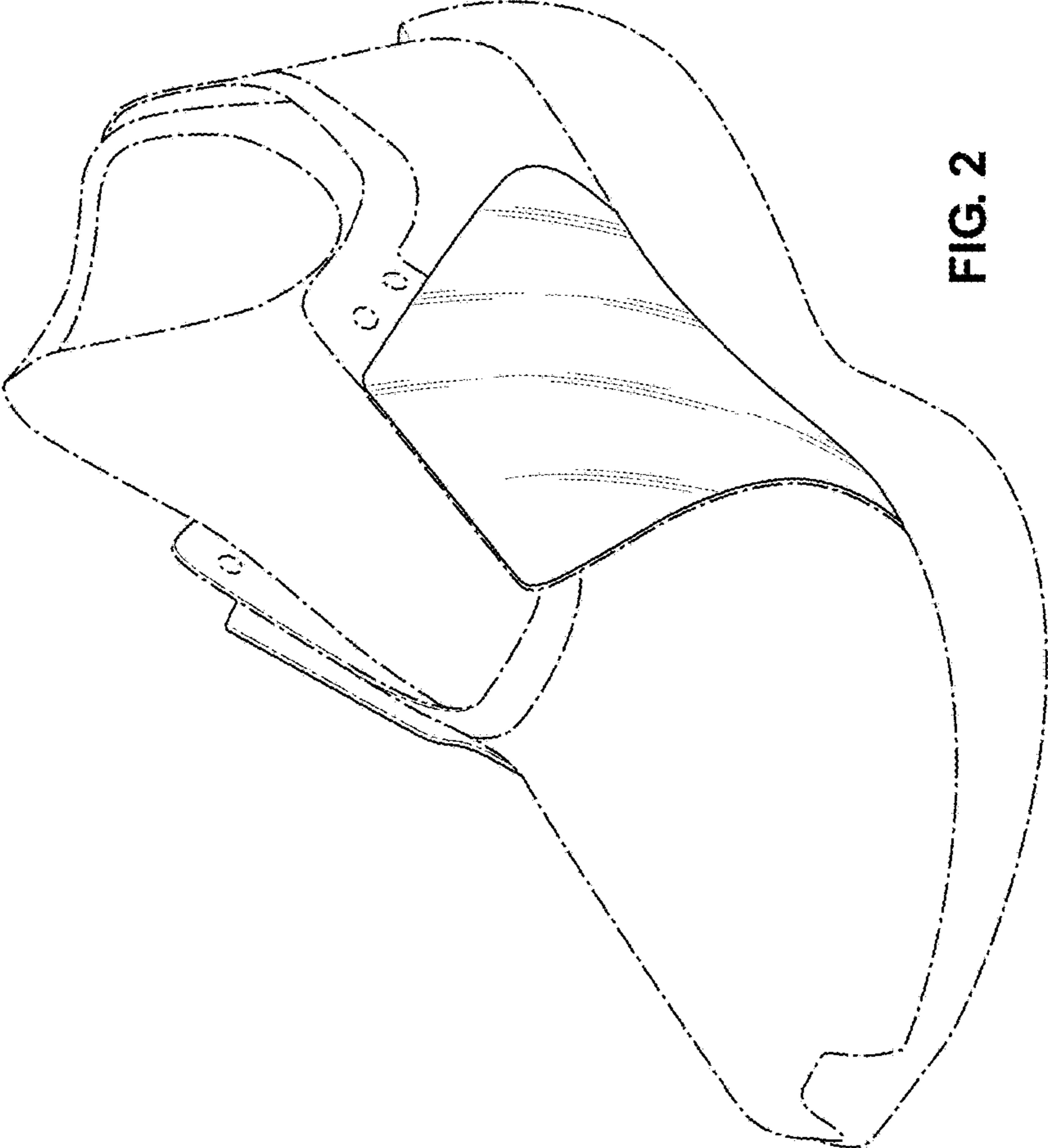

FIG. 2

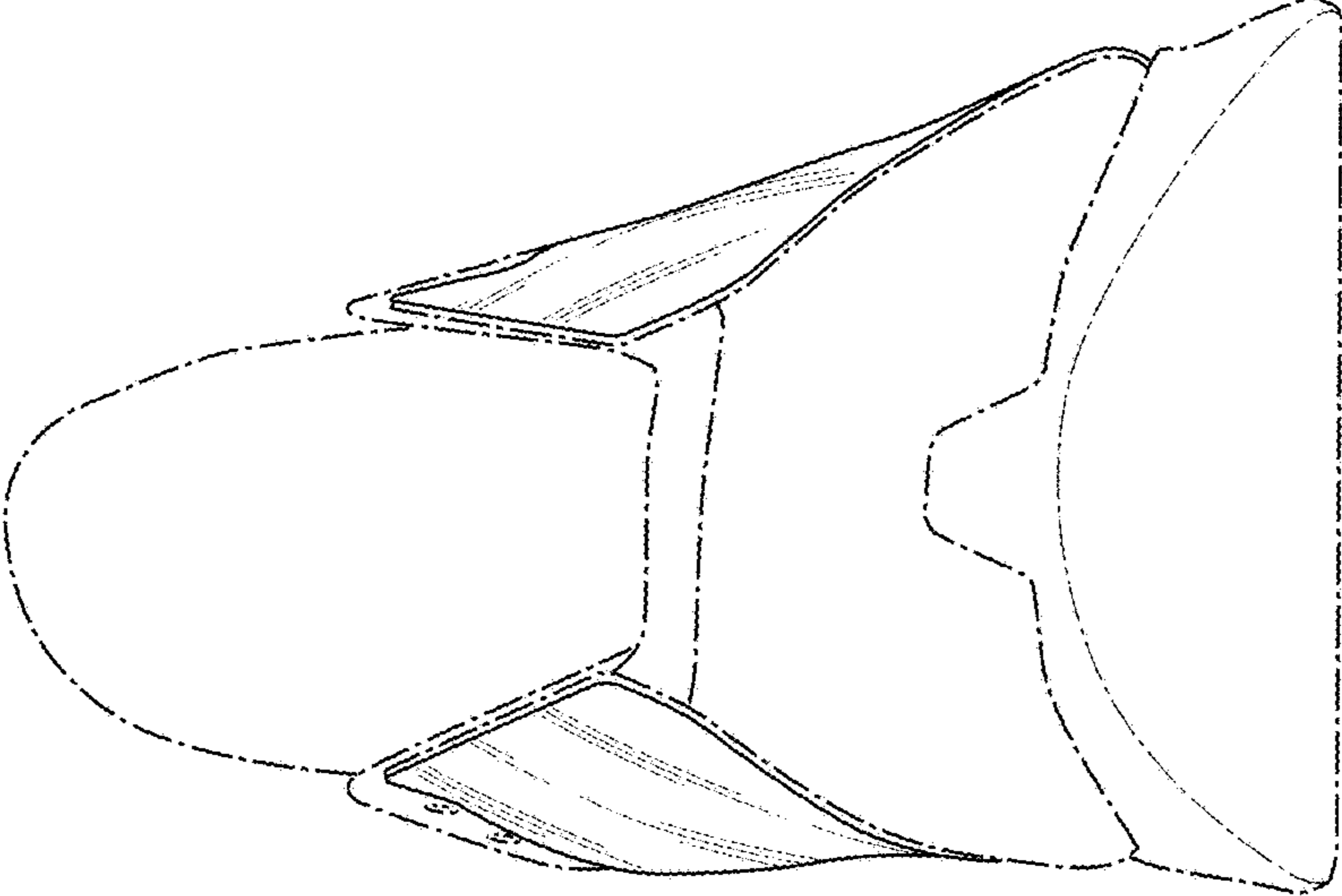

FIG. 3

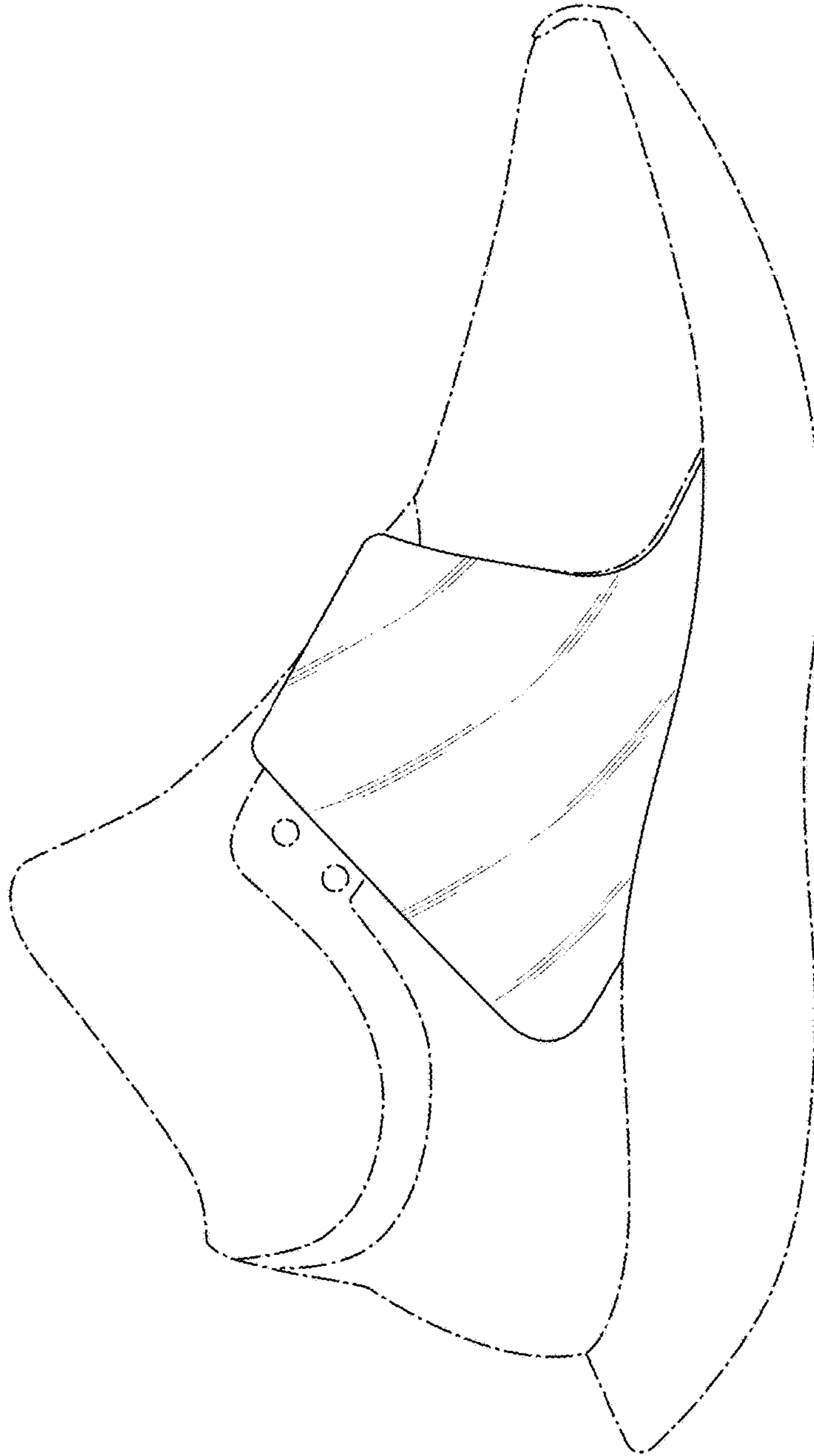

FIG. 4

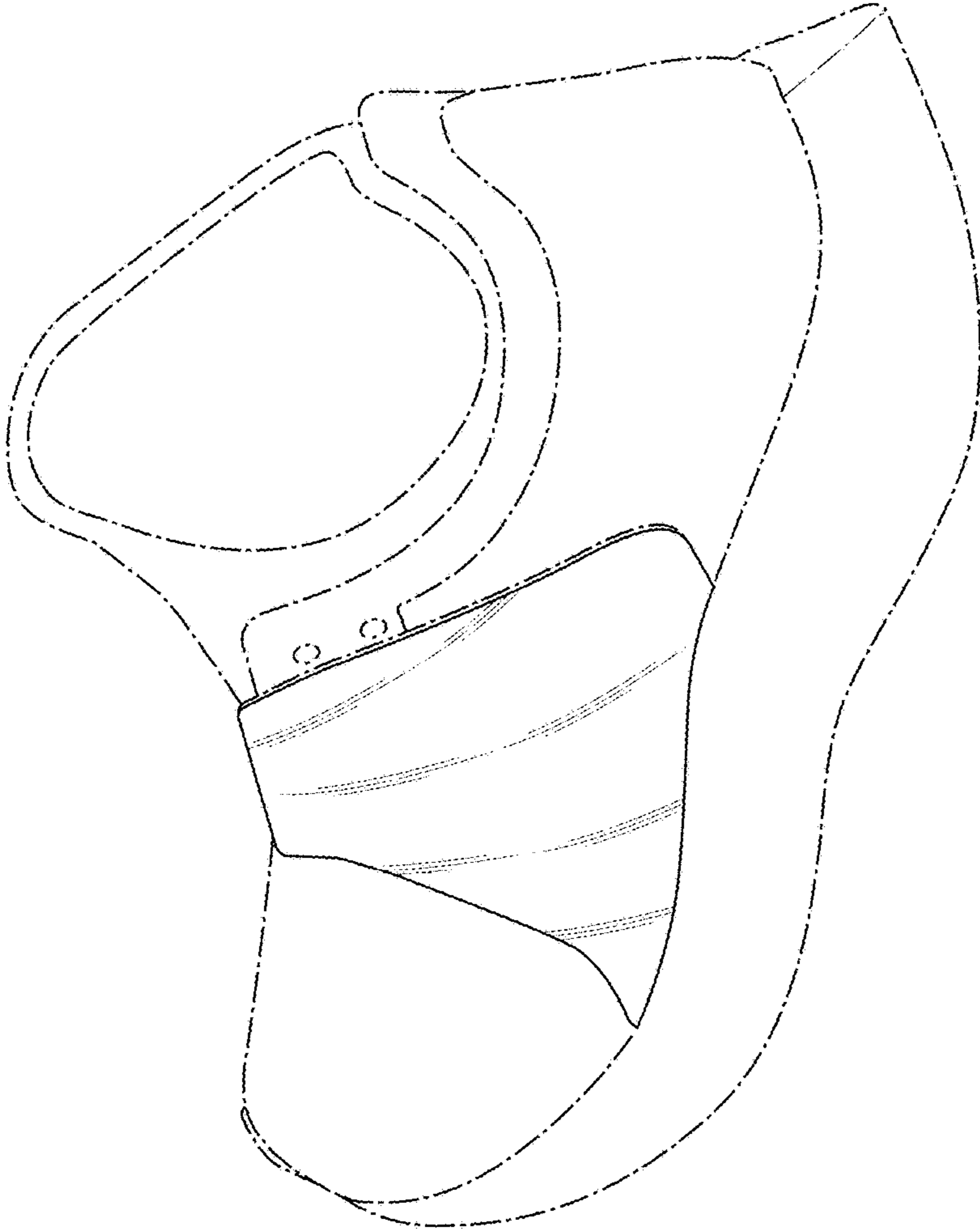

FIG. 5

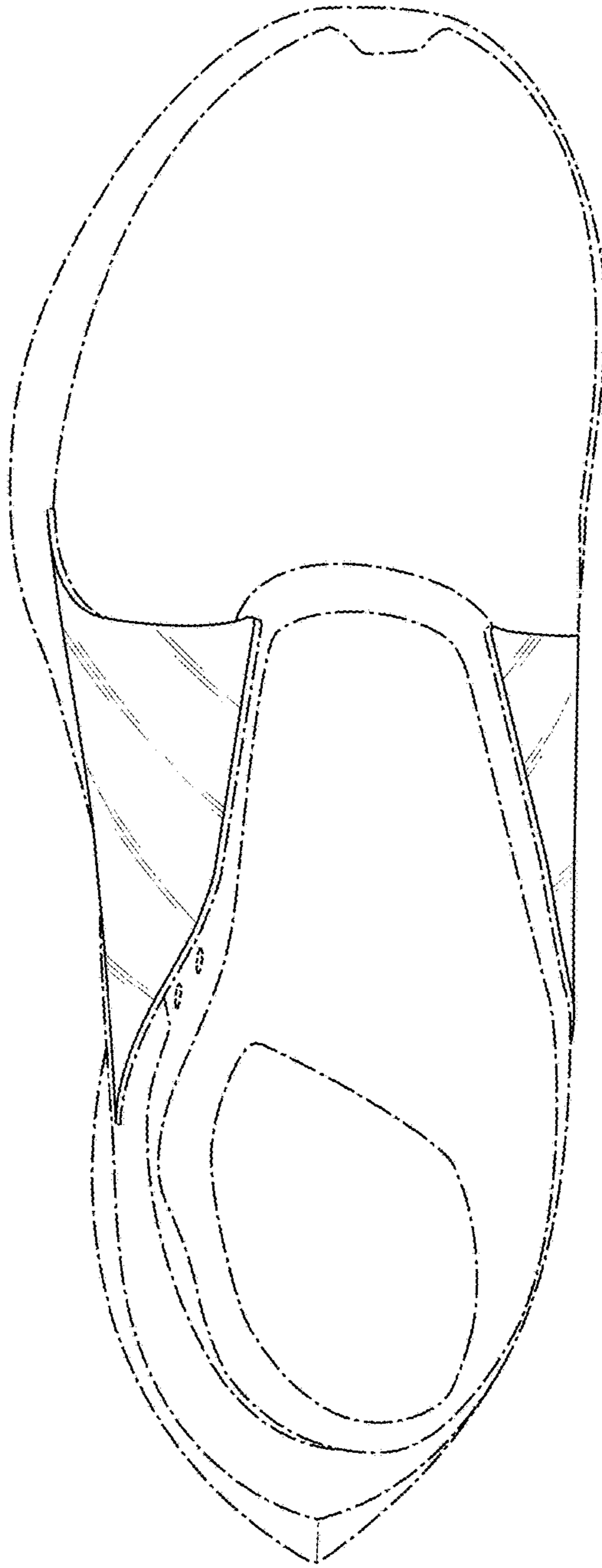

FIG. 6