



US00D853681S

(12) **United States Design Patent**
Colquhoun et al.

(10) **Patent No.:** **US D853,681 S**
(45) **Date of Patent:** **** Jul. 16, 2019**

(54) **FOOD PRODUCT**

(71) Applicant: **Mars, Incorporated**, McLean, VA (US)

(72) Inventors: **Duncan Colquhoun**, Bath (GB); **John Macdonald**, Bath (GB); **Matthew Wright**, Bath (GB)

(73) Assignee: **Mars, Incorporated**, McLean, VA (US)

(**) Term: **15 Years**

(21) Appl. No.: **29/588,252**

(22) Filed: **Dec. 19, 2016**

(51) **LOC (11) Cl.** **01-01**

(52) **U.S. Cl.**

USPC **D1/122**

(58) **Field of Classification Search**

USPC D1/100-130, 199; 426/5, 76, 87, 92, 94, 426/95, 99, 101, 103, 104, 108, 134, 426/138-139, 143, 144, 279, 282, 283, 426/391, 514, 549, 559, 560, 660, 808; D9/430, 439, 754; 521/50; D13/110; 220/574; D8/83; D21/487; D26/37, 38, D26/46, 49

(Continued)

(56) **References Cited**

U.S. PATENT DOCUMENTS

D19,126 S * 6/1889 Bell D23/386
3,164,507 A * 1/1965 Akiyoshi B31D 3/02
156/197

(Continued)

Primary Examiner — Katie Jane Stofko

(74) *Attorney, Agent, or Firm* — Greenberg Traurig, LLP

(57) **CLAIM**

The ornamental design for a food product, as shown and described.

DESCRIPTION

FIG. 1 is a front, left, top perspective view of a first embodiment of a food product showing our new design; FIG. 2 is a front elevation view of the first embodiment of the food product shown in FIG. 1; FIG. 3 is a rear elevation view of the first embodiment of the food product shown in FIG. 1; FIG. 4 is a left side elevation view of the first embodiment of the food product shown in FIG. 1; FIG. 5 is a right side elevation view of the first embodiment of the food product shown in FIG. 1; FIG. 6 is a top plan view of the first embodiment of the food product shown in FIG. 1; FIG. 7 is a bottom plan view of the first embodiment of the food product shown in FIG. 1; FIG. 8 is a front, left, top perspective view of a second embodiment of a food product showing our new design; FIG. 9 is a front elevation view of the second embodiment of the food product shown in FIG. 8; FIG. 10 is a rear elevation view of the second embodiment of the food product shown in FIG. 8; FIG. 11 is a left side elevation view of the second embodiment of the food product shown in FIG. 8; FIG. 12 is a right side elevation view of the second embodiment of the food product shown in FIG. 8; FIG. 13 is a top plan view of the second embodiment of the food product shown in FIG. 8; and, FIG. 14 is a bottom plan view of the second embodiment of the food product shown in FIG. 8.

The break lines shown in the middle portion of the food product in FIGS. 1 and 4-7 indicate that the appearance of any portion of the article between the break lines forms no part of the claimed design.

The evenly-spaced broken lines in FIGS. 1 and 4-7 illustrate portions of the food product that form no part of the claimed design.

1 Claim, 8 Drawing Sheets

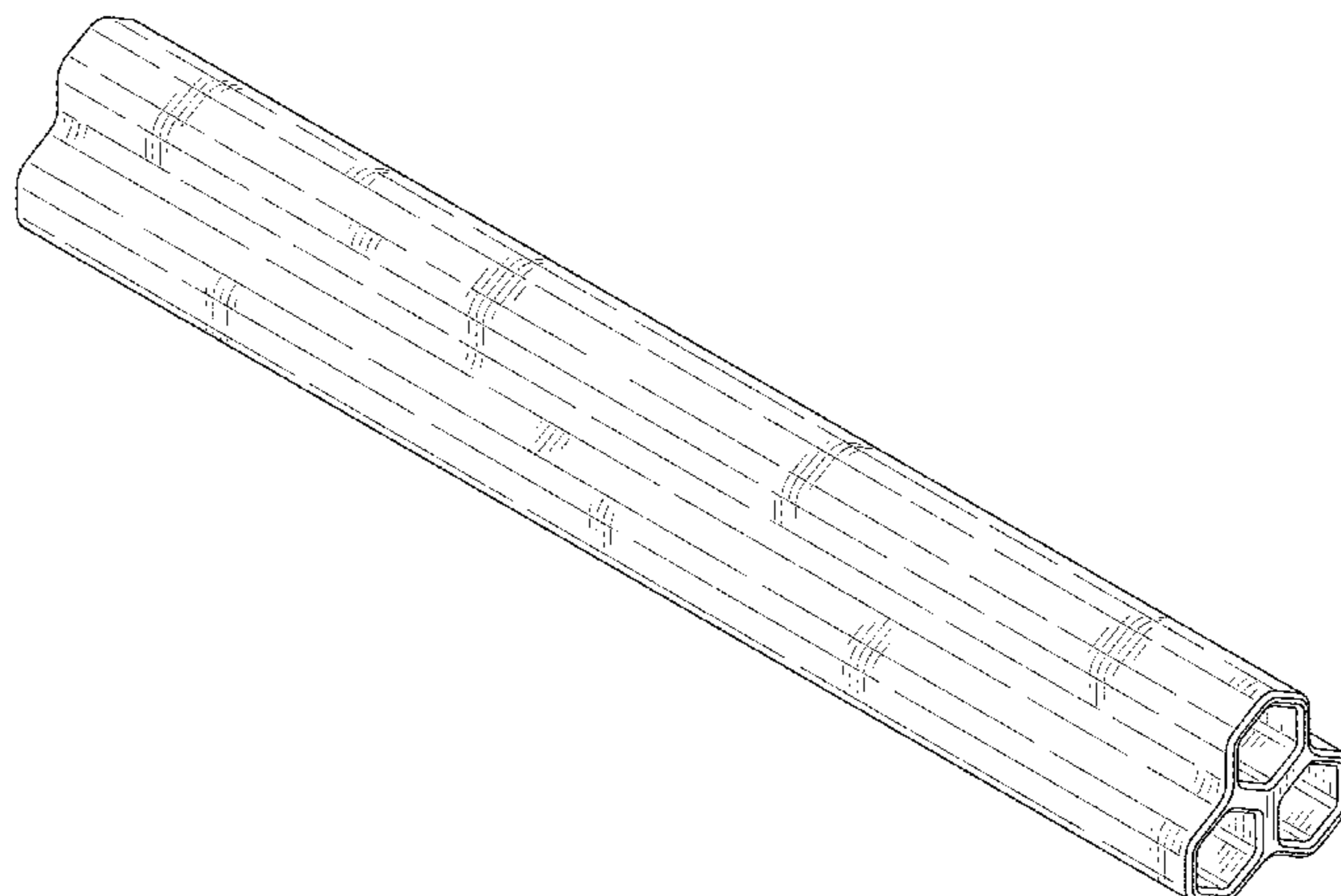
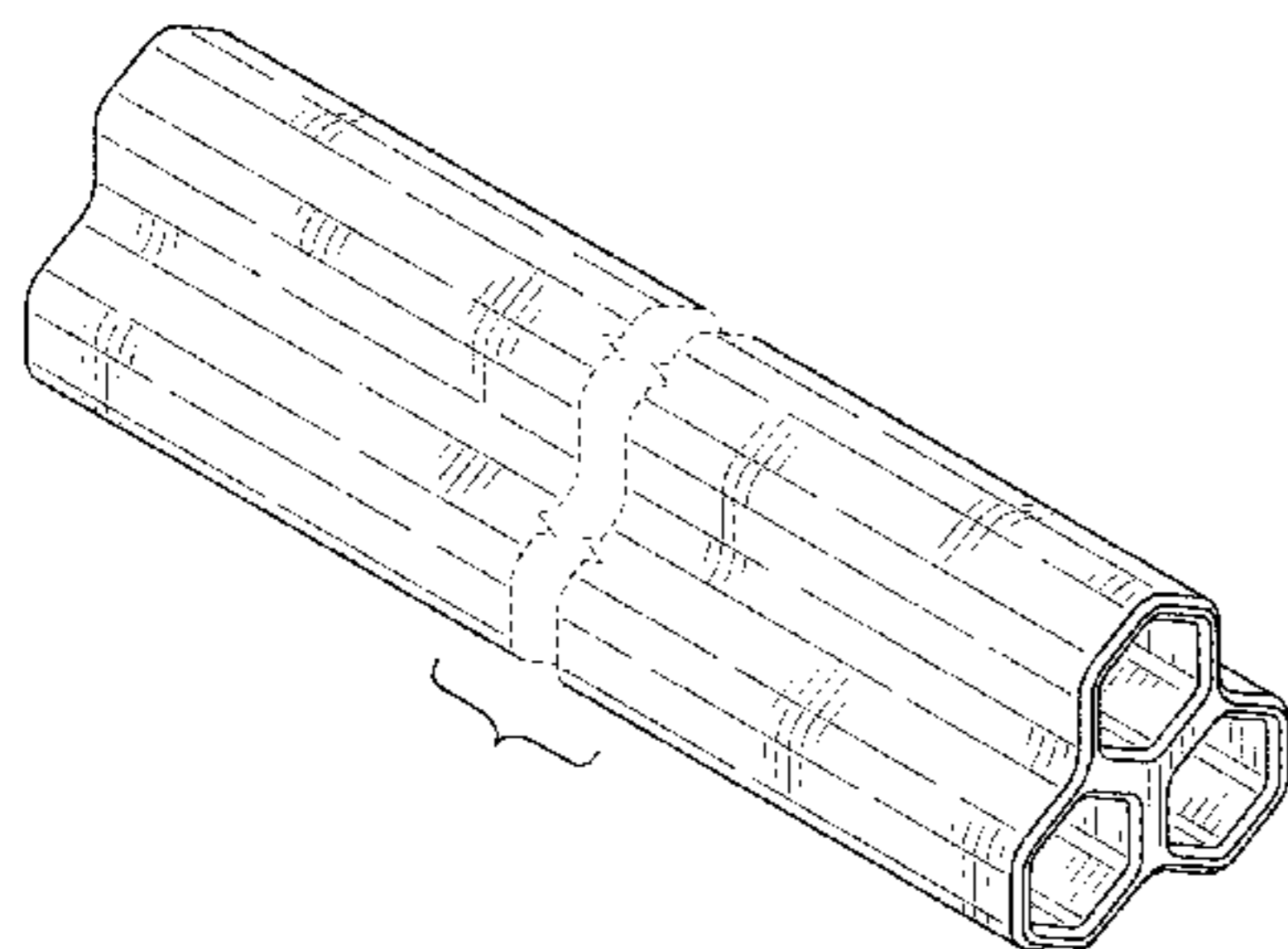

(58) **Field of Classification Search**
 CPC A21D 13/0029; A21D 13/0074; A21D
 13/0022; A21D 13/0006; A23L 1/1641;
 A23L 1/005
 See application file for complete search history.

(56) **References Cited**
 U.S. PATENT DOCUMENTS

3,389,748 A * 6/1968 Hitch B21D 47/00
 165/170
 3,992,010 A * 11/1976 Mattenson A63F 3/00097
 273/153 R
 4,167,911 A * 9/1979 Masuda A01C 11/02
 111/105
 4,453,344 A * 6/1984 Van Wingerden A01C 11/02
 47/85
 4,578,899 A * 4/1986 Katila F02B 71/045
 47/86
 4,964,192 A * 10/1990 Marui B62K 21/26
 16/421
 4,969,568 A * 11/1990 Yoshida B43M 99/008
 211/186

5,106,444 A * 4/1992 Corey B31F 1/245
 156/197
 5,155,935 A * 10/1992 Tanimura A01G 9/0295
 47/86
 D370,034 S * 5/1996 Kipfer D21/386
 5,595,020 A * 1/1997 Ito A01G 9/0295
 47/66.5
 5,888,639 A * 3/1999 Green B29C 65/7443
 156/250
 5,987,845 A * 11/1999 Laronde B27M 3/0053
 52/591.1
 D489,865 S * 5/2004 Pavan D1/124
 D536,390 S * 2/2007 Van Ness D21/386
 D642,648 S * 8/2011 Oliver D22/108
 D655,026 S * 2/2012 Schrimmer D26/38
 D665,320 S * 8/2012 Najarro D12/194
 D694,160 S * 11/2013 Chou D12/194
 D747,066 S * 1/2016 Roetheli D1/106
 9,320,355 B2 * 4/2016 Lee A47B 73/006
 D796,344 S * 9/2017 Paulick D25/115
 2015/0174881 A1 * 6/2015 Stoll B29D 99/0089
 428/116

* cited by examiner

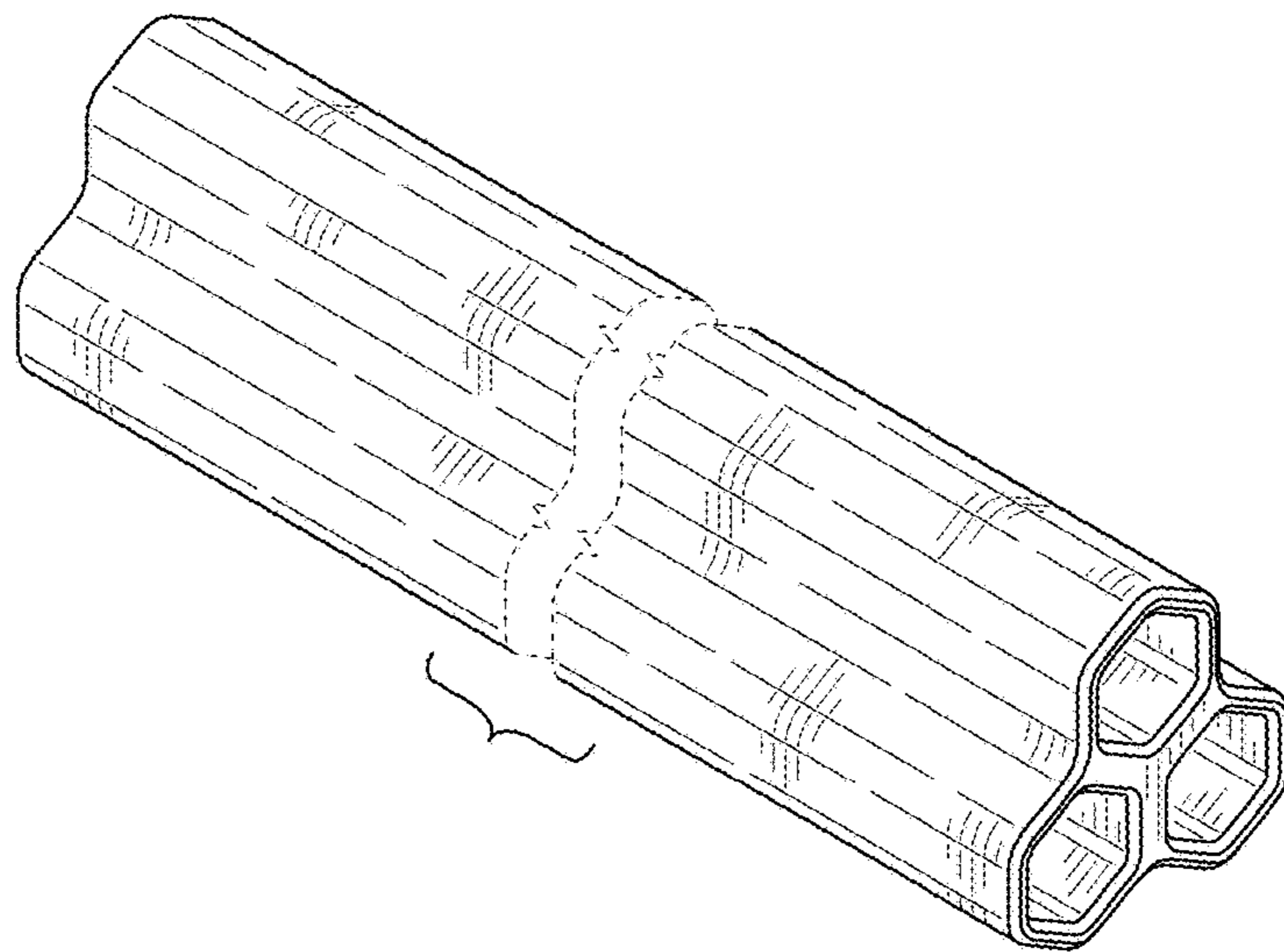

FIG. 1

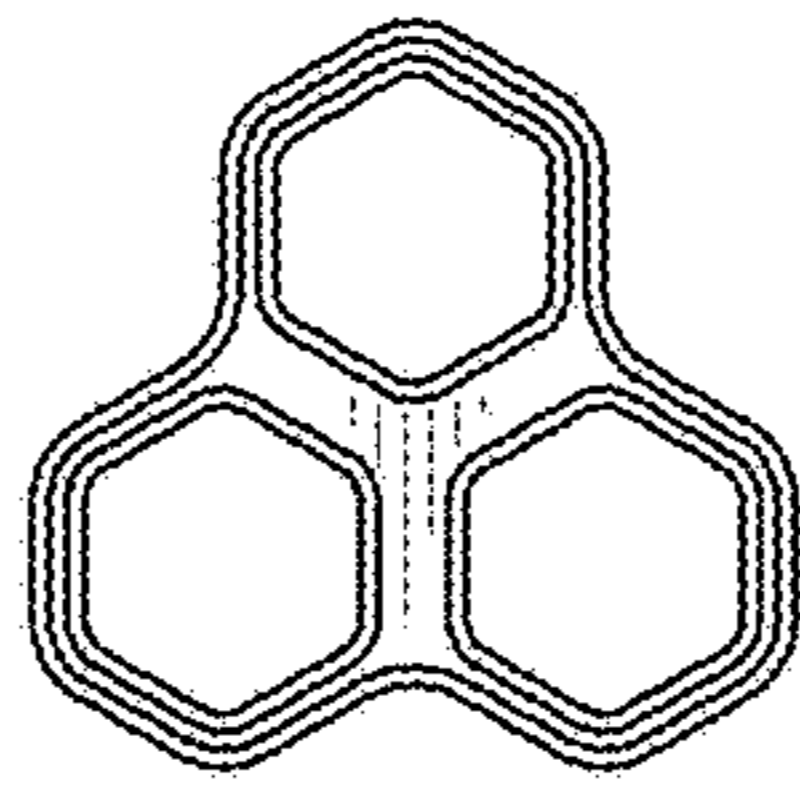

FIG. 2

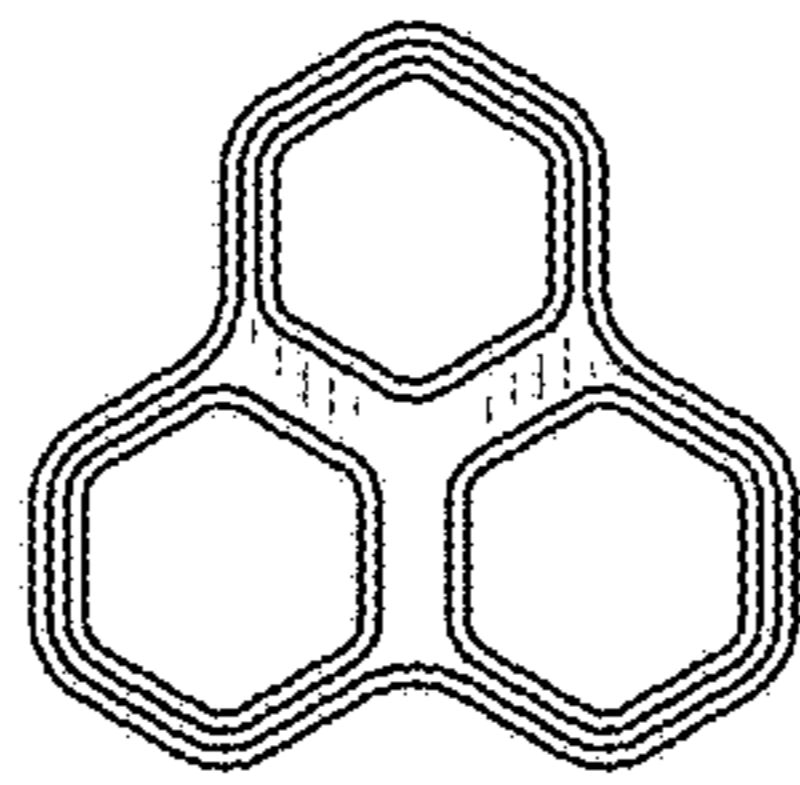

FIG. 3

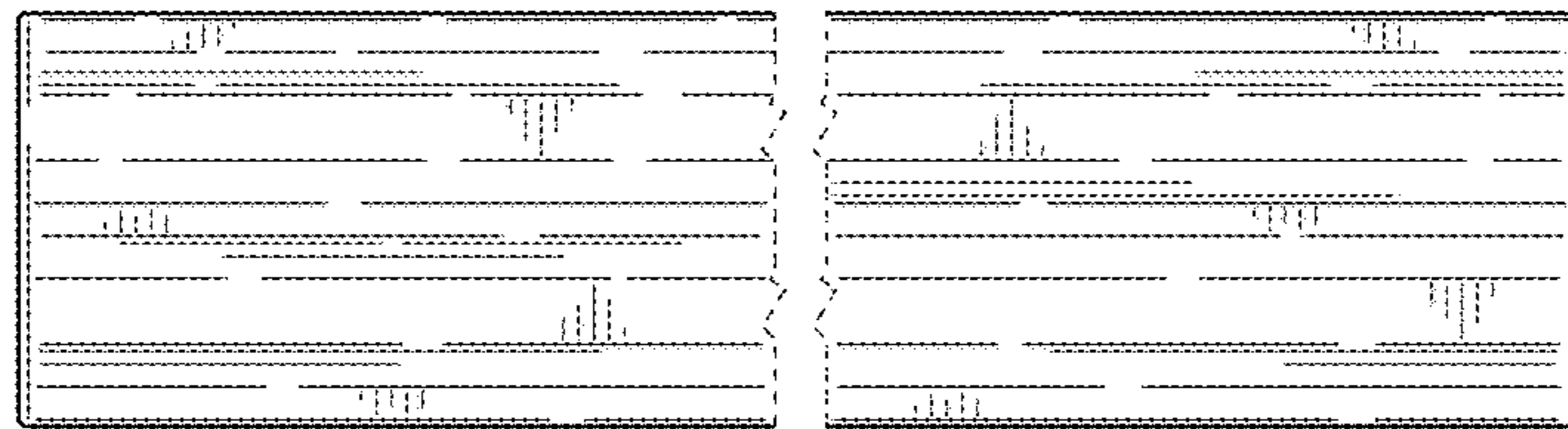

FIG. 4

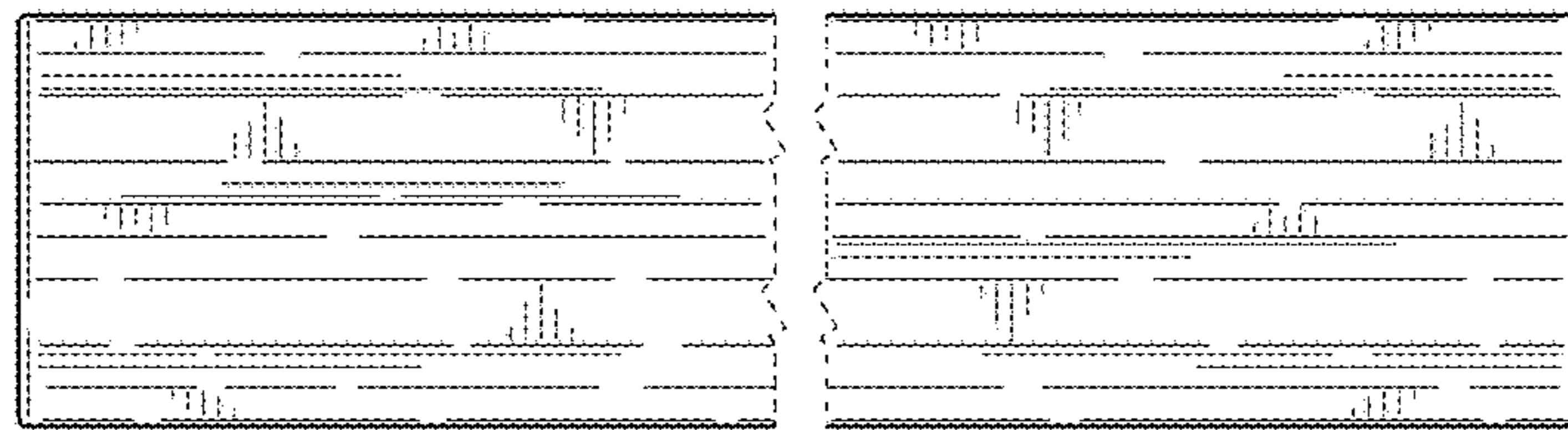

FIG. 5

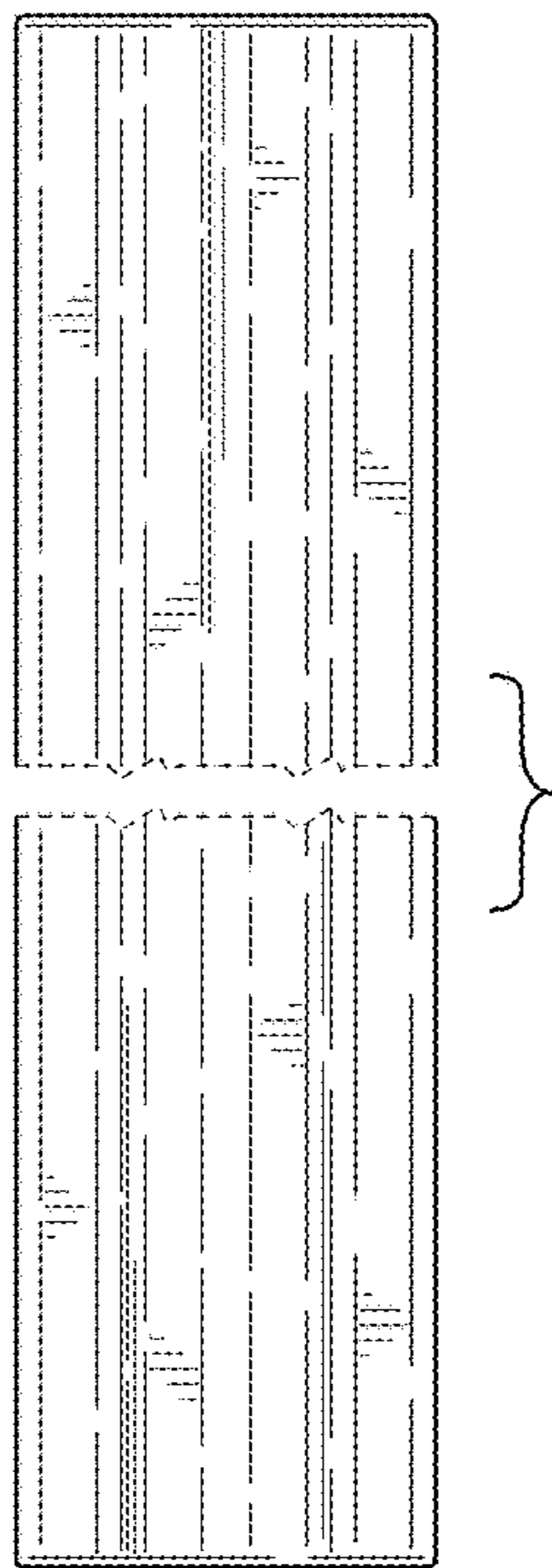

FIG. 6

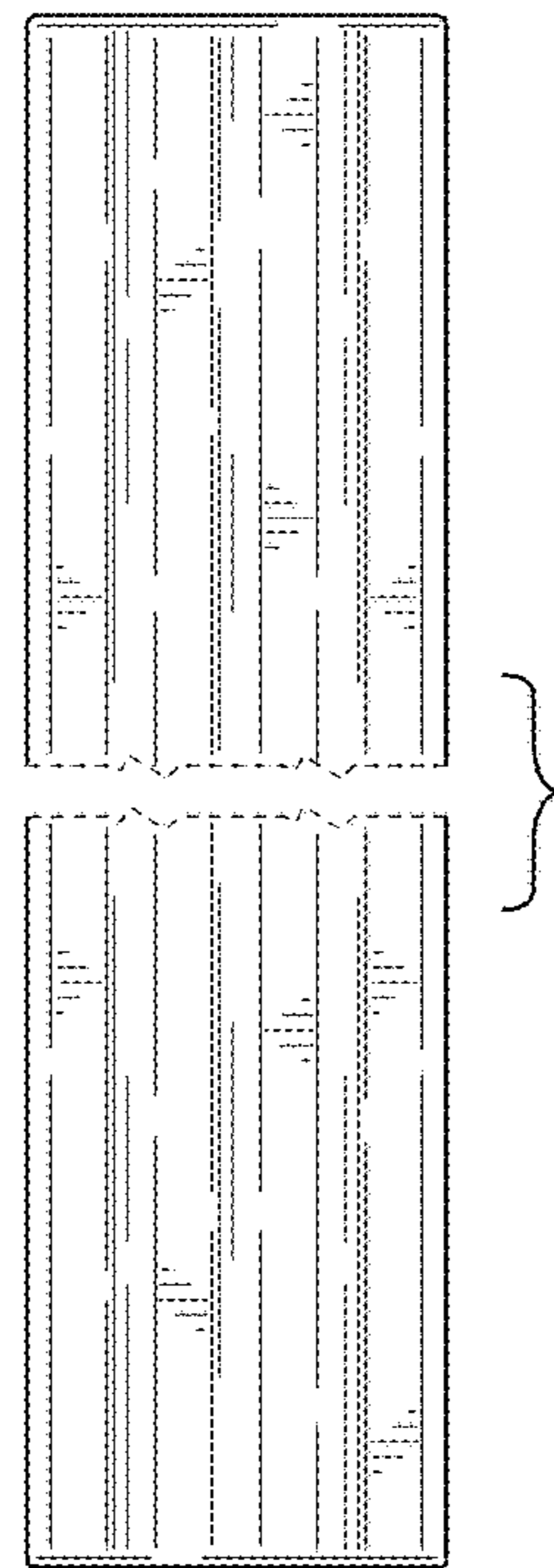

FIG. 7

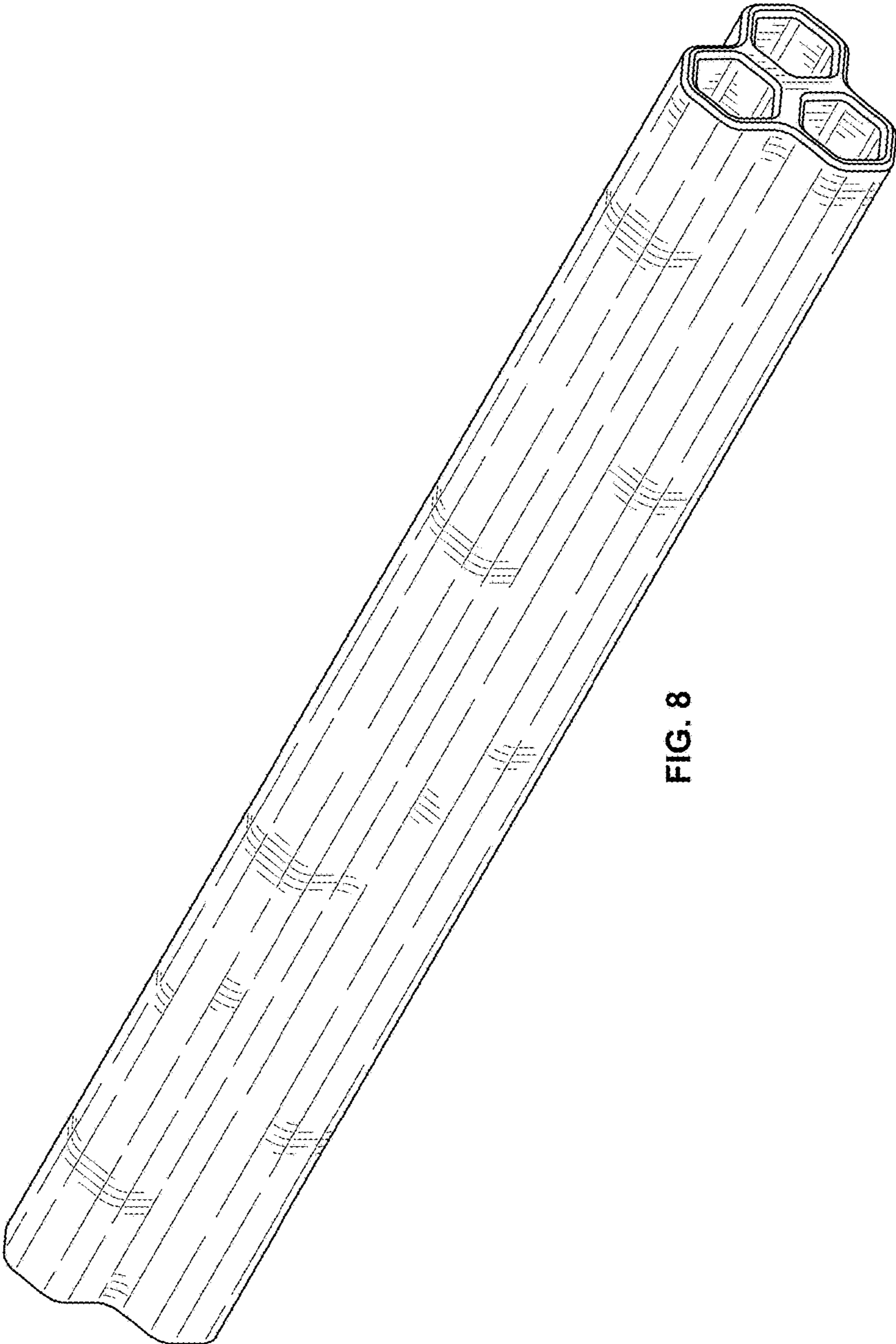

FIG. 8

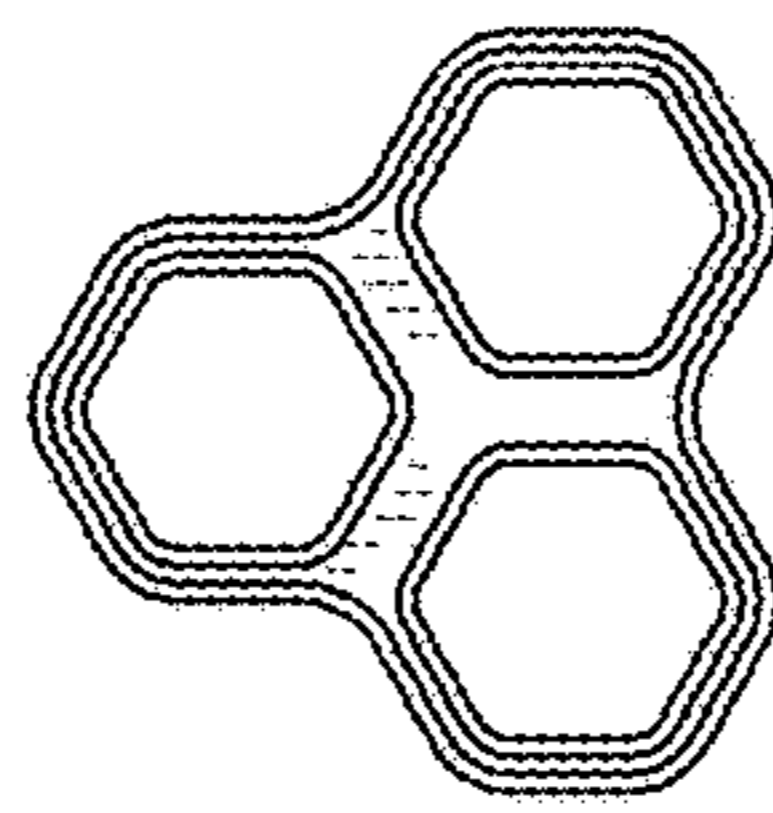

FIG. 10

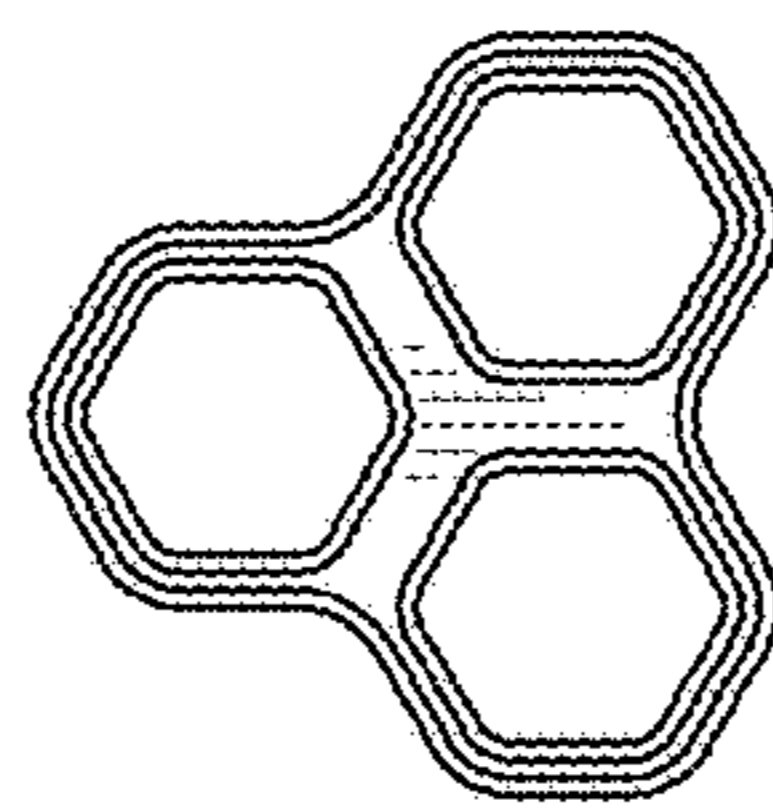

FIG. 9

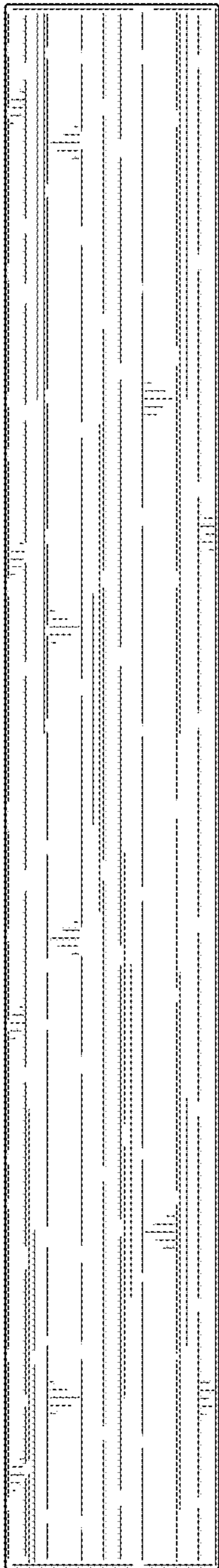

FIG. 11

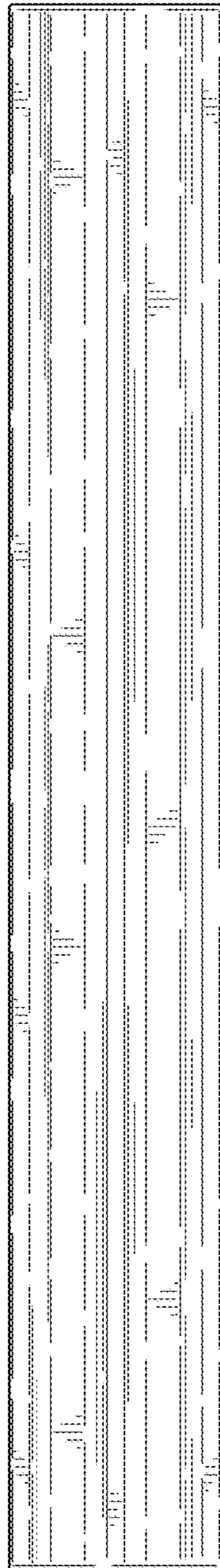

FIG. 12

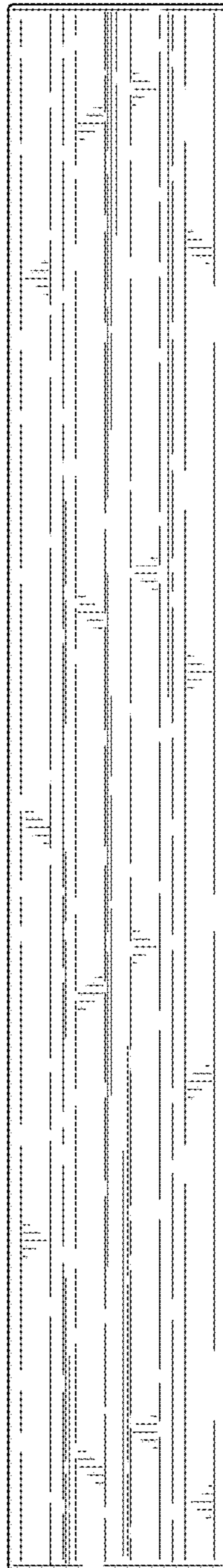

FIG. 13

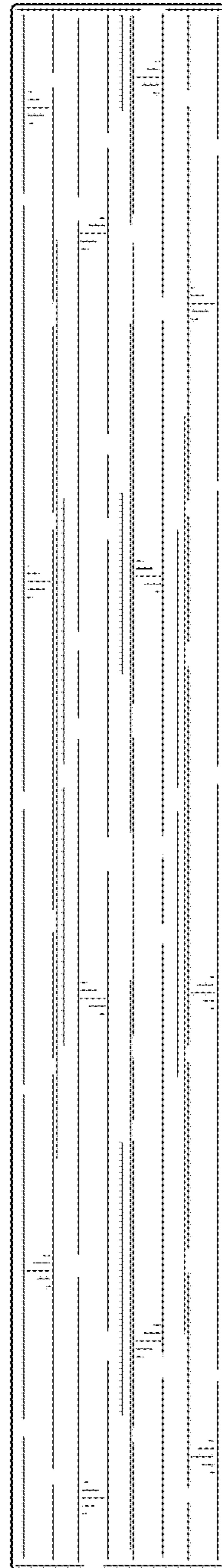

FIG. 14