

US00D853561S

(12) **United States Design Patent** (10) **Patent No.:** **US D853,561 S**
Guo (45) **Date of Patent:** **** Jul. 9, 2019**

(54) **IMPLANTATION DEVICE**

(71) Applicant: **Chengjun Guo**, Beijing (CN)

(72) Inventor: **Chengjun Guo**, Beijing (CN)

(73) Assignee: **Chengjun Guo**

(**) Term: **15 Years**

(21) Appl. No.: **29/648,054**

(22) Filed: **May 17, 2018**

(30) **Foreign Application Priority Data**

Feb. 16, 2018 (CN) 2018 1 0158832

(51) **LOC (11) Cl.** **24-02**

(52) **U.S. Cl.**
USPC **D24/138**

(58) **Field of Classification Search**
USPC D24/138, 144, 145, 146, 140, 147, 133,
D24/112, 113, 130, 134, 135
CPC A61M 1/1008; A61M 2039/062; A61M
2039/0626; A61B 1/32; A61F 2002/2484;
A61F 2/2466; A61N 1/057; A61N
1/0573; A61N 1/372

See application file for complete search history.

(56) **References Cited**

U.S. PATENT DOCUMENTS

- 2,531,730 A * 11/1950 Henderson A61C 17/043
285/343
- D287,165 S * 12/1986 Lipsky D24/112
- D372,778 S * 8/1996 Brunson D24/112
- D390,656 S * 2/1998 Linder D24/112
- D441,863 S * 5/2001 Khalaj D24/133
- D533,270 S * 12/2006 Kierce D24/112
- D611,600 S * 3/2010 Stammberger D24/138
- 8,505,531 B2 * 8/2013 Pecherer A61M 16/0488
128/200.26
- 8,795,253 B2 * 8/2014 Moshinsky A61M 25/0041
604/523
- D724,725 S * 3/2015 Chang D24/133
- D760,381 S * 6/2016 Fox D24/112

(Continued)

FOREIGN PATENT DOCUMENTS

CN	304170302	*	6/2017	
CN	107233665		10/2017	
GB	2500893	*	12/2017 A61B 5/09

OTHER PUBLICATIONS

YouTube. Link: https://www.youtube.com/watch?v=nmmh_21pqA0. Feb. 14, 2017. Watchman Implant Device for AFib. (Year: 2017).*

Primary Examiner — Susan Bennett Hattan

Assistant Examiner — Lauren D McVey

(74) *Attorney, Agent, or Firm* — Treasure IP Group, LLC

(57) **CLAIM**

The ornamental design for an implantation device, as shown and described.

DESCRIPTION

FIG. 1 is a perspective view of a first embodiment of an implantation device showing my new design;
 FIG. 2 is a front view thereof;
 FIG. 3 is a rear view thereof;
 FIG. 4 is a left side view thereof;
 FIG. 5 is a right side view thereof;
 FIG. 6 is a top view thereof;
 FIG. 7 is a bottom view thereof.
 FIG. 8 is a perspective view of a second embodiment of the implantation device showing my new design;
 FIG. 9 is a front view thereof;
 FIG. 10 is a rear view thereof;
 FIG. 11 is a left side view thereof;
 FIG. 12 is a right side view thereof;
 FIG. 13 is a top view thereof; and,
 FIG. 14 is a bottom view thereof.

1 Claim, 14 Drawing Sheets

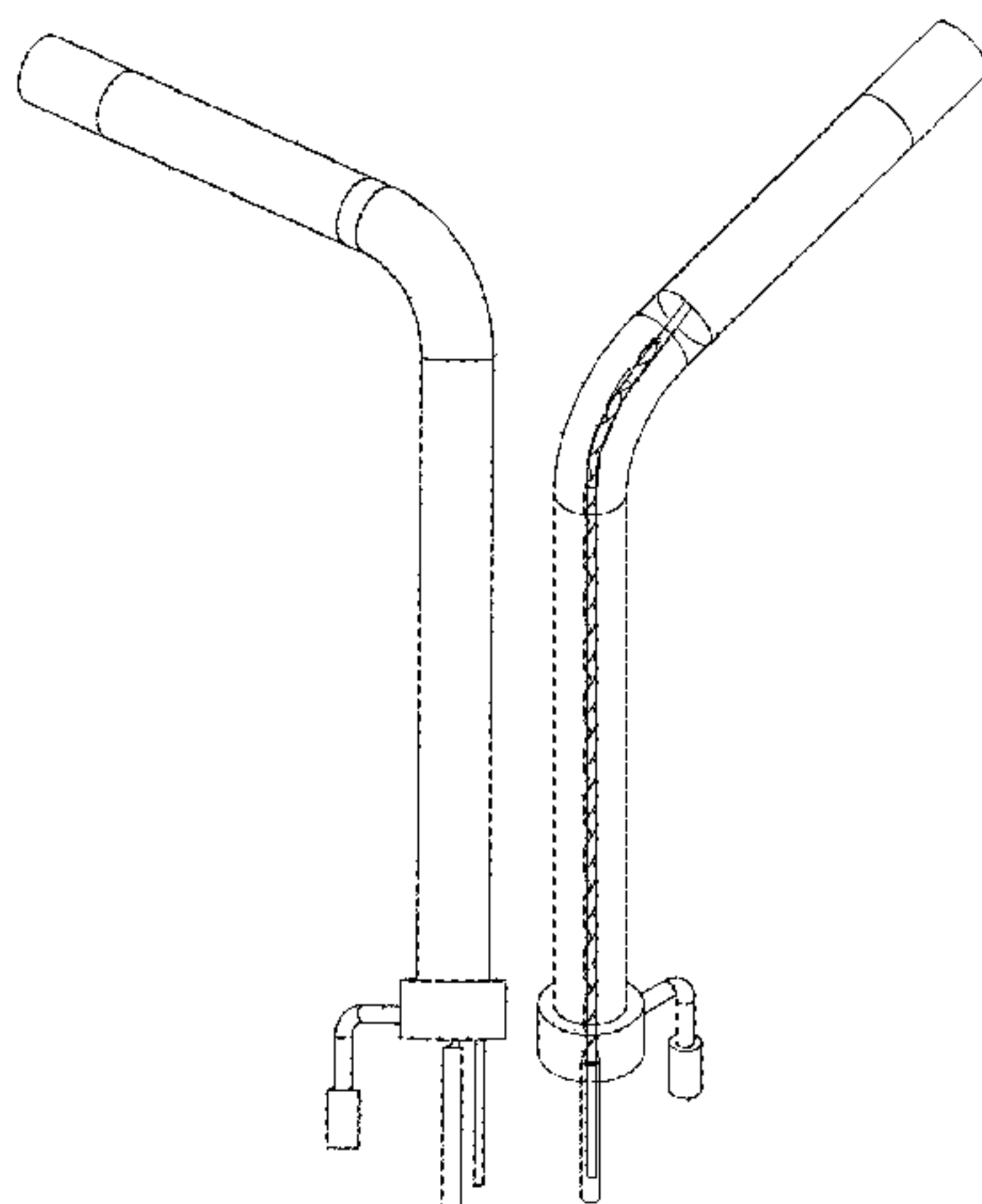

(56)

References Cited

U.S. PATENT DOCUMENTS

2008/0057100 A1* 3/2008 Williams A61N 1/05
424/423
2014/0142689 A1* 5/2014 De Canniere A61F 2/2457
623/2.11

* cited by examiner

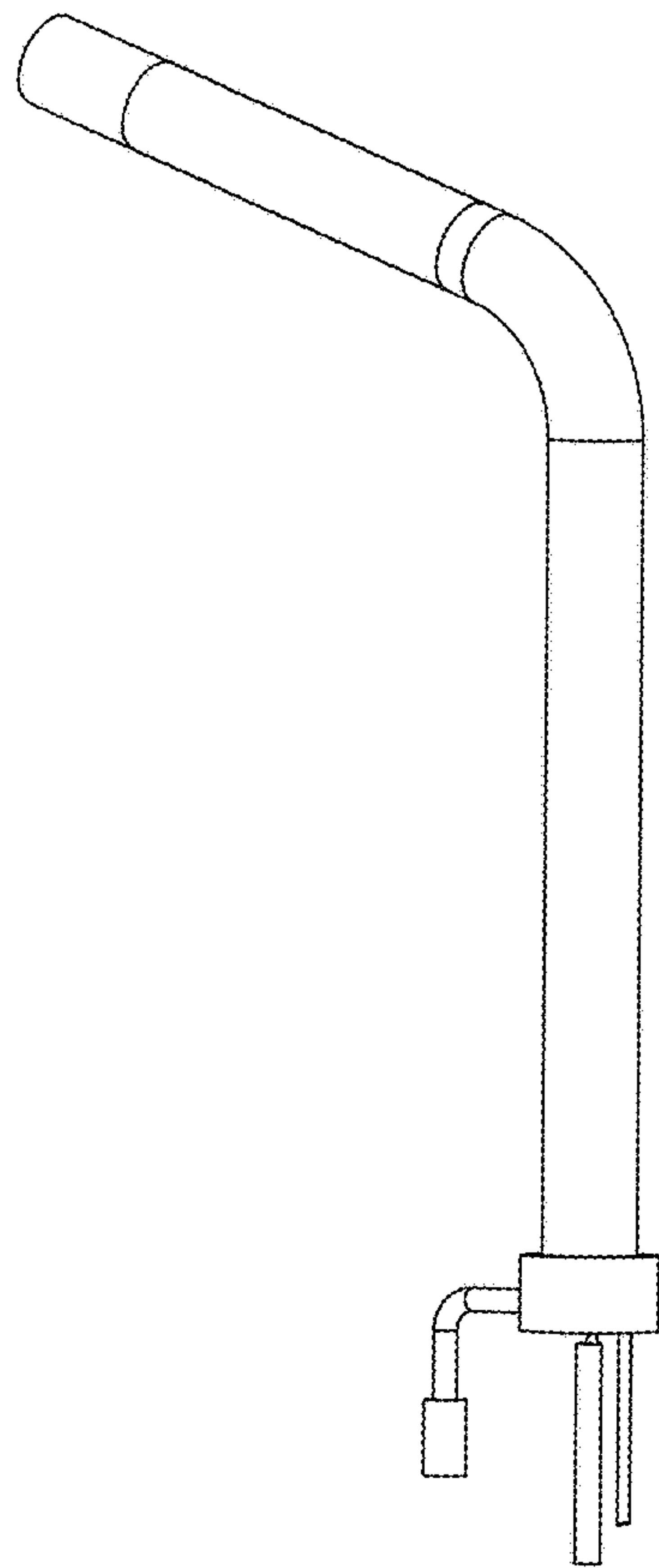

Fig. 1

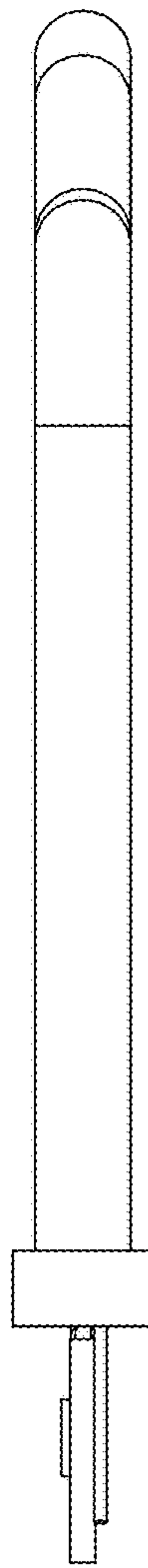

Fig. 2

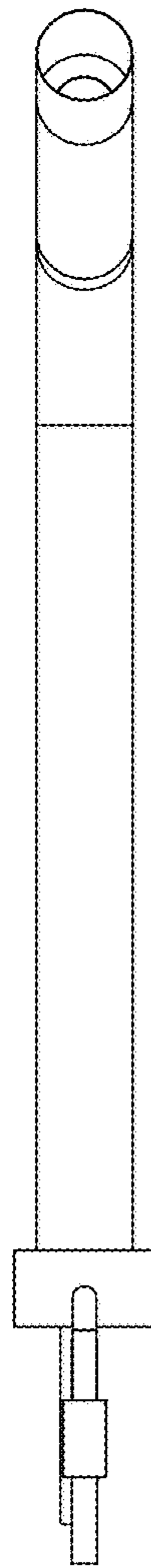

Fig. 3

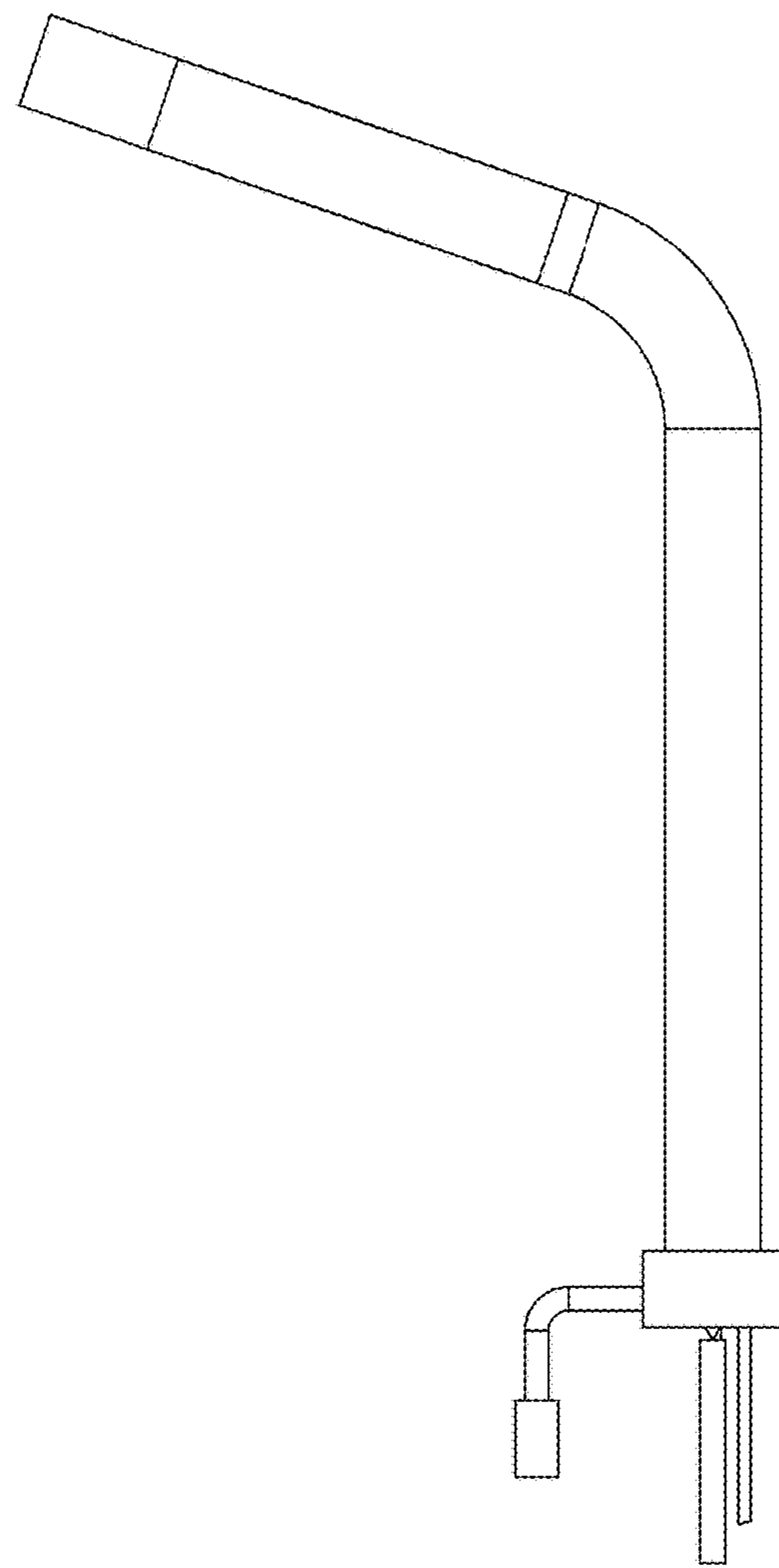

Fig. 4

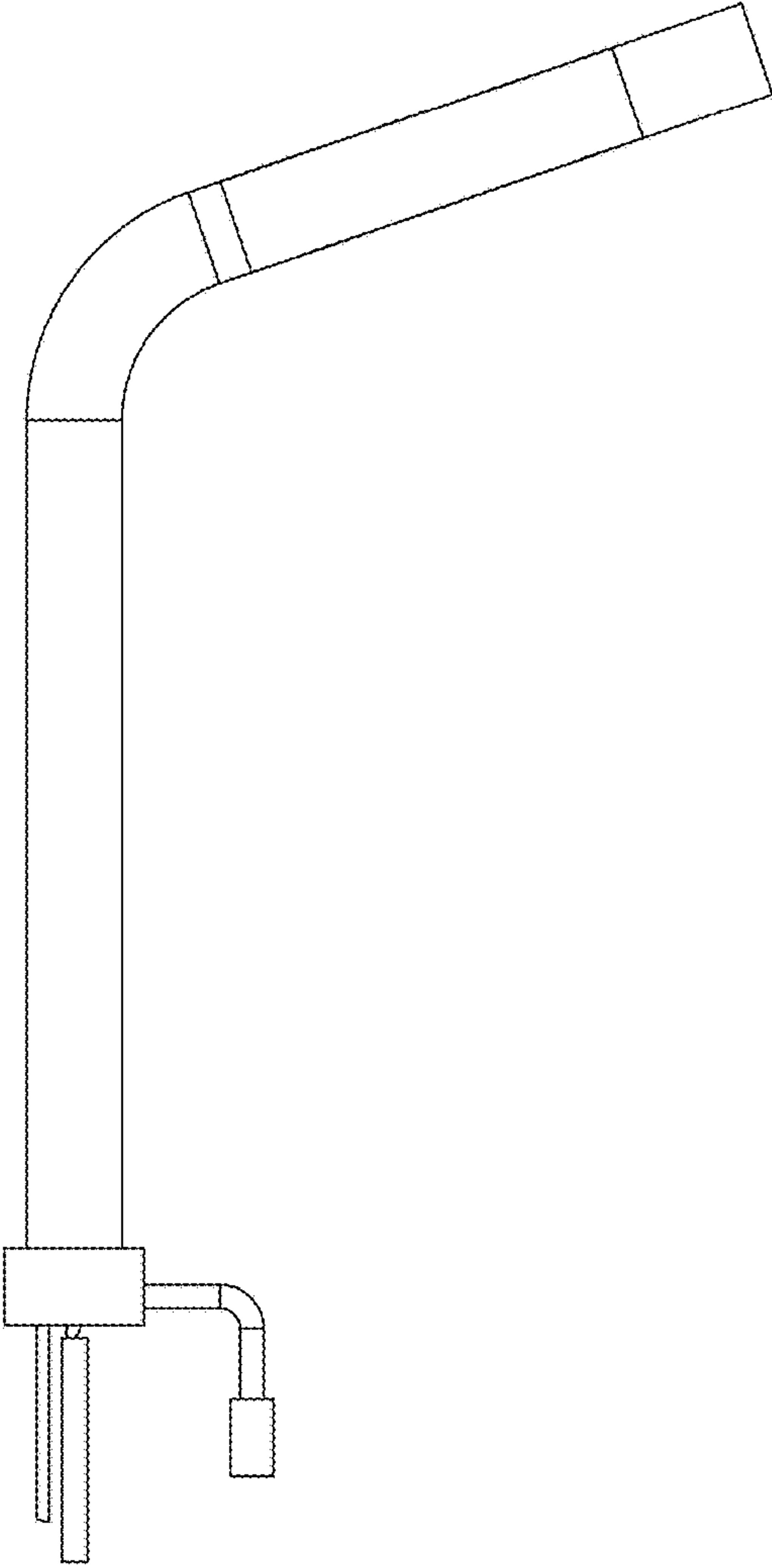

Fig. 5

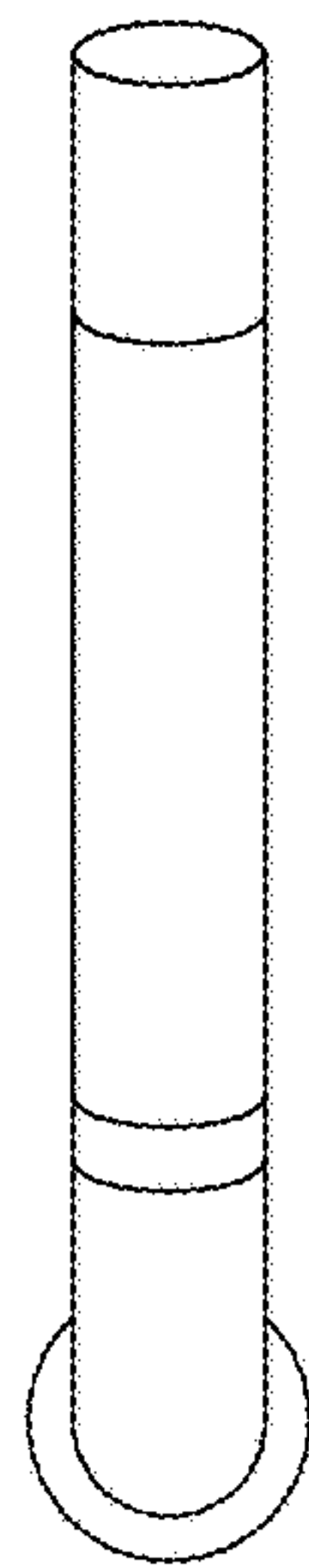

Fig. 6

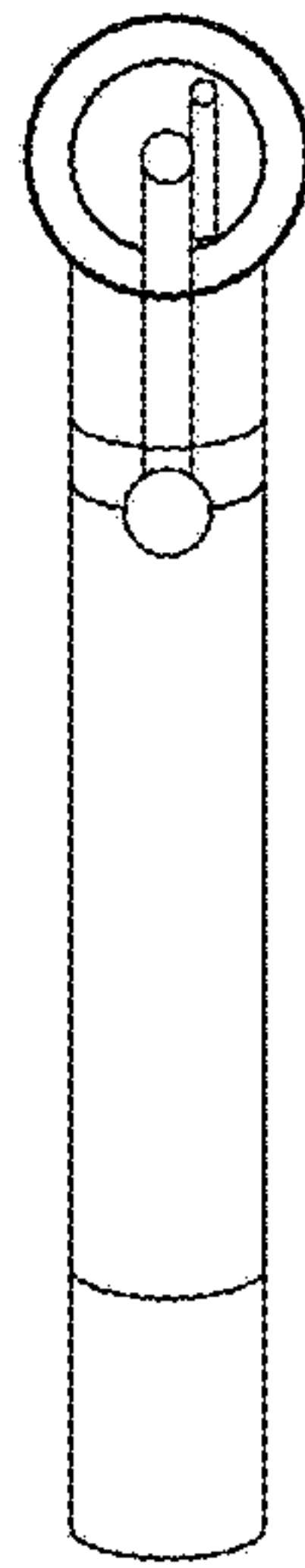

Fig. 7

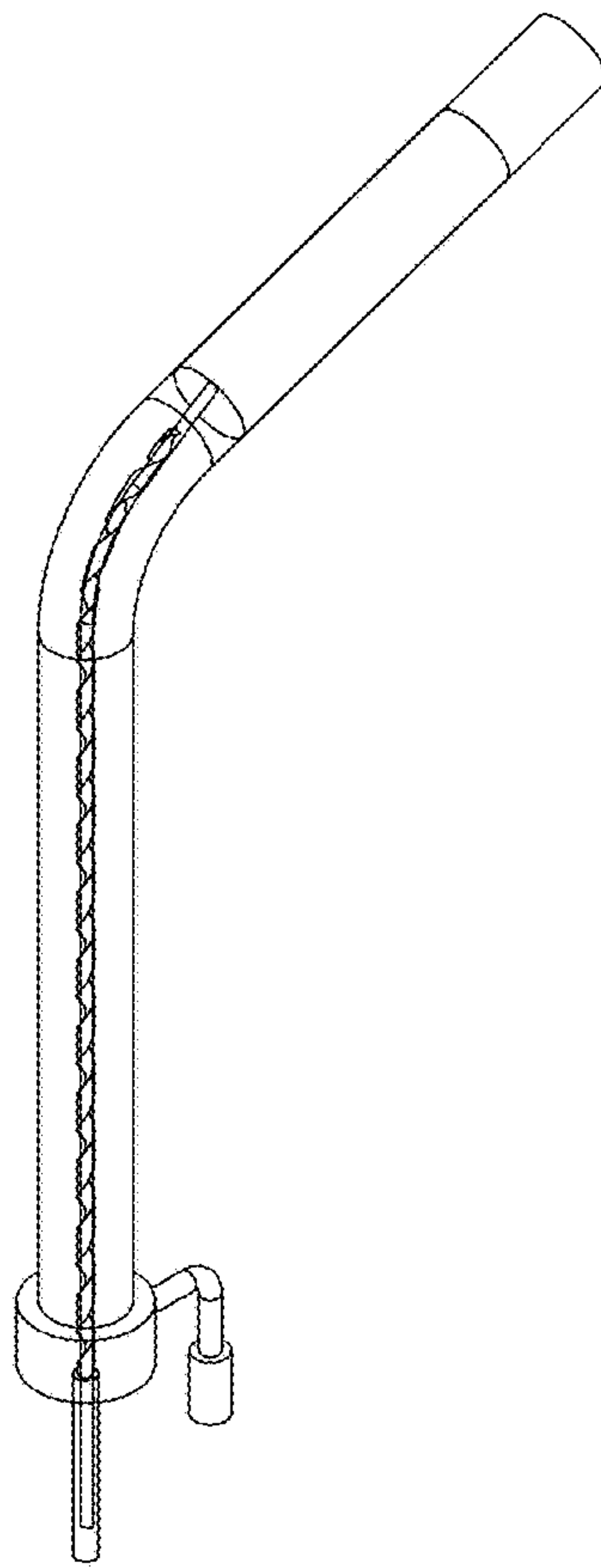

FIG. 8

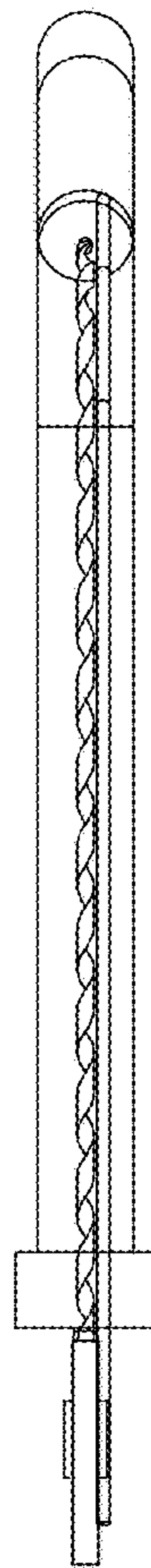

FIG. 9

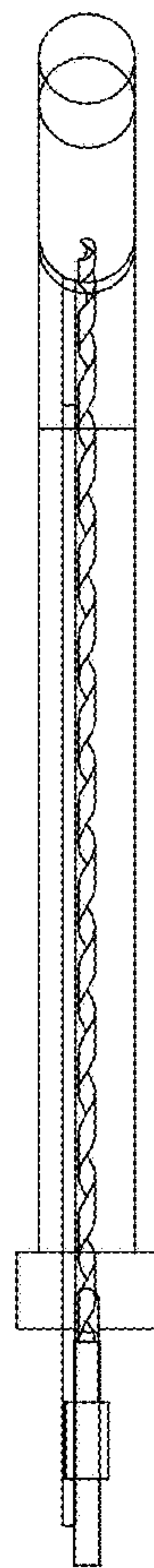

FIG. 10

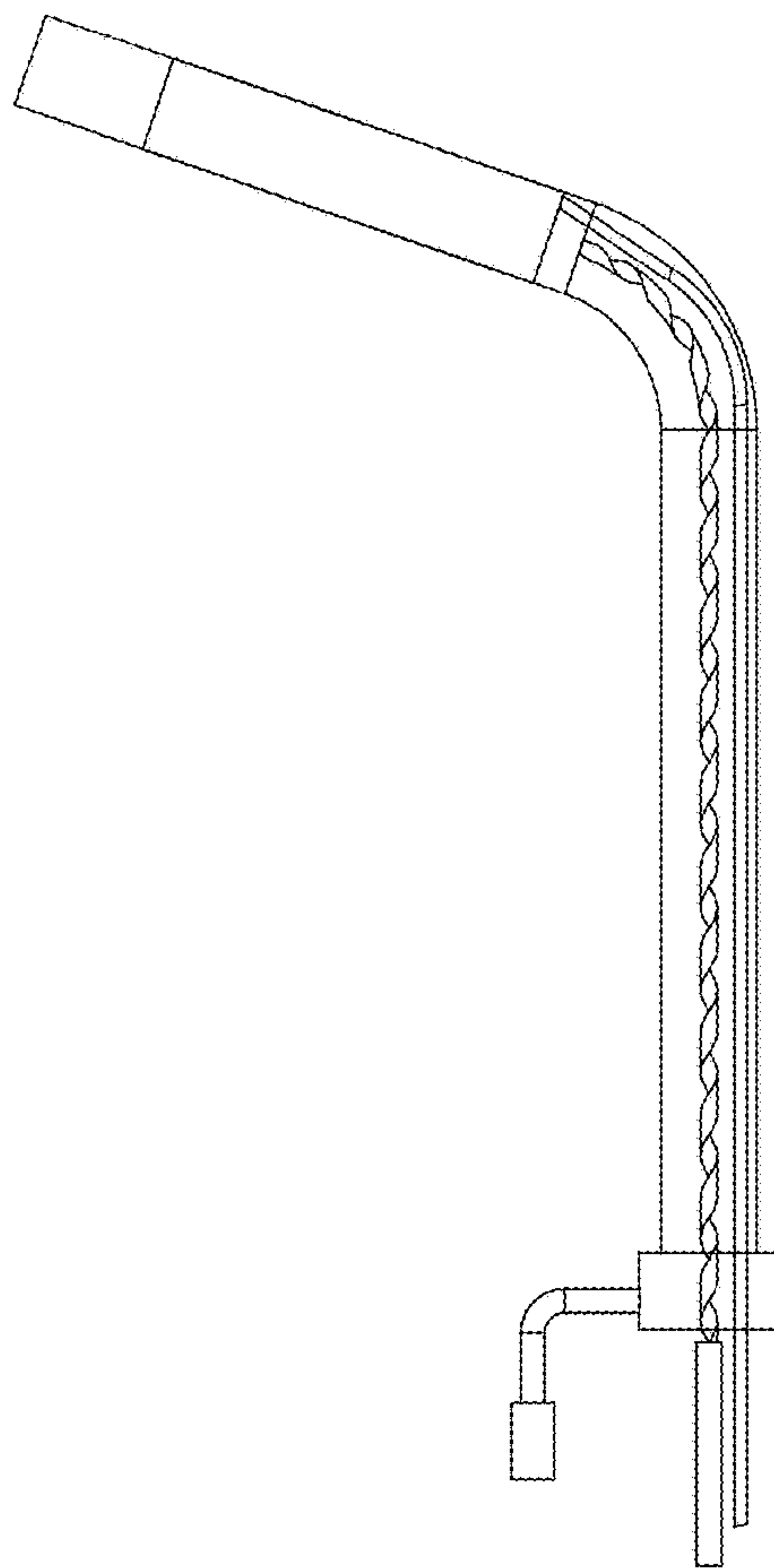

FIG. 11

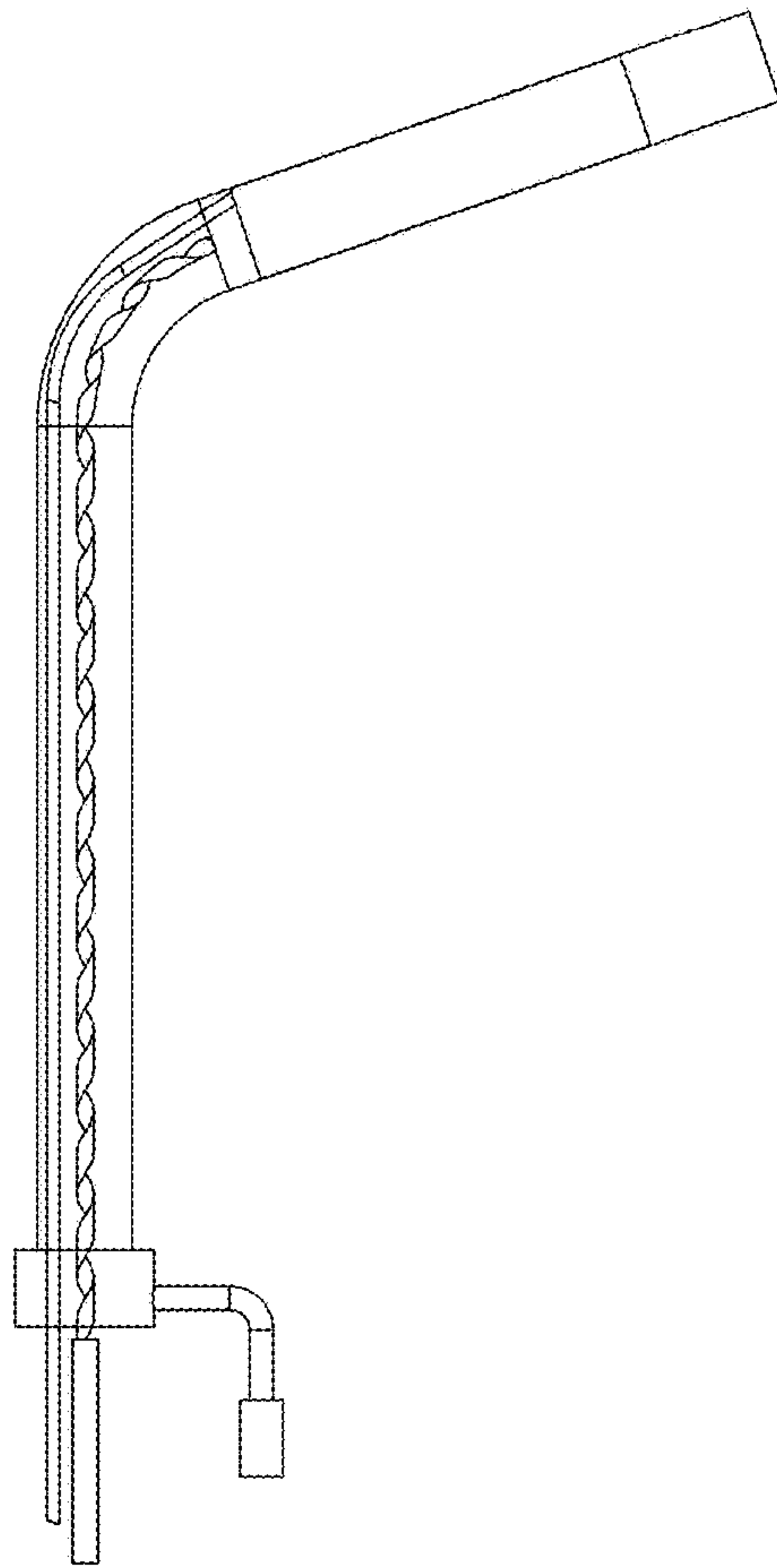

FIG. 12

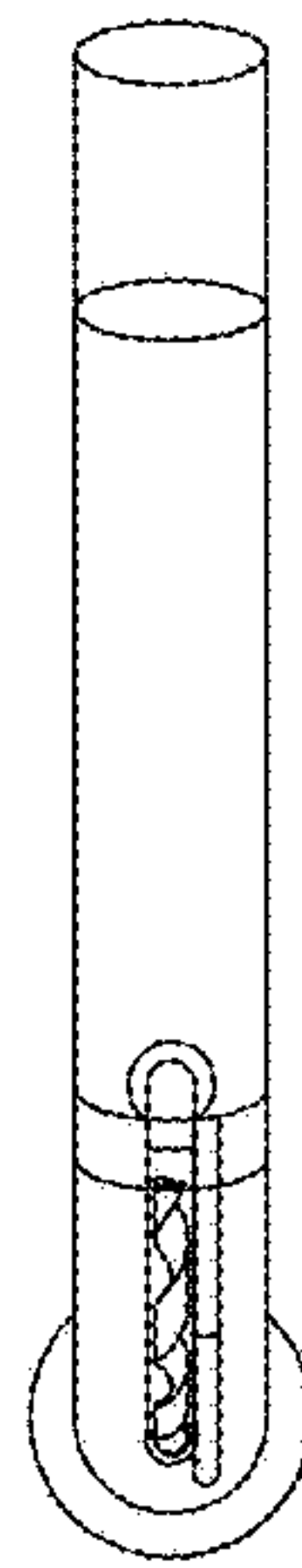

FIG. 13



FIG. 14