



US00D853536S

(12) **United States Design Patent** (10) **Patent No.:** **US D853,536 S**
Cullen (45) **Date of Patent:** **** Jul. 9, 2019**

- (54) **DEBRIS FILTER FOR A GUTTER**
- (71) Applicant: **Universal Manufacturing & Design, LLC, Tampa, FL (US)**
- (72) Inventor: **James M. Cullen, Aroda, VA (US)**
- (73) Assignee: **Universal Manufacturing & Design, LLC, Palm Harbor, FL (US)**
- (**) Term: **15 Years**
- (21) Appl. No.: **29/628,718**
- (22) Filed: **Dec. 7, 2017**

Related U.S. Application Data

- (63) Continuation-in-part of application No. 15/465,102, filed on Mar. 21, 2017, now Pat. No. 10,113,315.
- (51) **LOC (11) Cl.** **23-01**
- (52) **U.S. Cl.**
USPC **D23/267**
- (58) **Field of Classification Search**
USPC D23/259-260, 267, 209, 365; D25/119, D25/121-124, 133, 139, 141-142; 52/11-16
CPC ... E04D 13/076; E04D 13/072; E04D 13/064; E04D 13/068; E04D 13/158; E04D 13/0641; E04D 13/0459; E04D 13/0477; E04D 13/0481; E04D 13/15
See application file for complete search history.

References Cited

U.S. PATENT DOCUMENTS

- 4,937,986 A * 7/1990 Way, Sr. E04D 13/076 210/474
- 6,598,352 B2 * 7/2003 Higginbotham E04D 13/076 210/474

- D523,538 S * 6/2006 Brochu D23/267
- 8,322,082 B2 * 12/2012 Neumann E04D 13/076 248/48.1
- D722,682 S * 2/2015 Fox D23/267
- 9,394,694 B2 * 7/2016 Iannelli E04D 13/064
- D770,602 S * 11/2016 Ealer, Sr. D23/267
- D819,790 S * 6/2018 Killian, Jr. D23/267
- 2015/0020462 A1 * 1/2015 Iannelli E04D 13/064 52/12
- 2016/0201329 A1 * 7/2016 Iannelli E04D 13/076 52/12
- 2018/0274239 A1 * 9/2018 Cullen E04D 13/076

* cited by examiner

Primary Examiner — Eric L Goodman
Assistant Examiner — Amy C Wierenga
(74) *Attorney, Agent, or Firm* — Larson & Larson, P.A.; Justin P. Miller; Frank Liebenow

(57) **CLAIM**

I claim the ornamental design for a debris filter for a gutter, as shown and described.

DESCRIPTION

FIG. 1 is a perspective view of a debris filter for a gutter showing my new design;
FIG. 2 is a top view thereof;
FIG. 3 is a bottom view thereof;
FIG. 4 is a front view thereof;
FIG. 5 is a back view thereof;
FIG. 6 is a right-side view thereof; and,
FIG. 7 is a left-side view thereof.
The broken lines depicting holes in FIGS. 1-3 are for the purpose of illustrating the unclaimed portions of the article and form no part of the claimed design. The debris filter for a gutter is shown with a symbolic break in its length in FIGS. 1-5. The appearance of any portion of the article between the break lines forms no part of the claim.

1 Claim, 5 Drawing Sheets

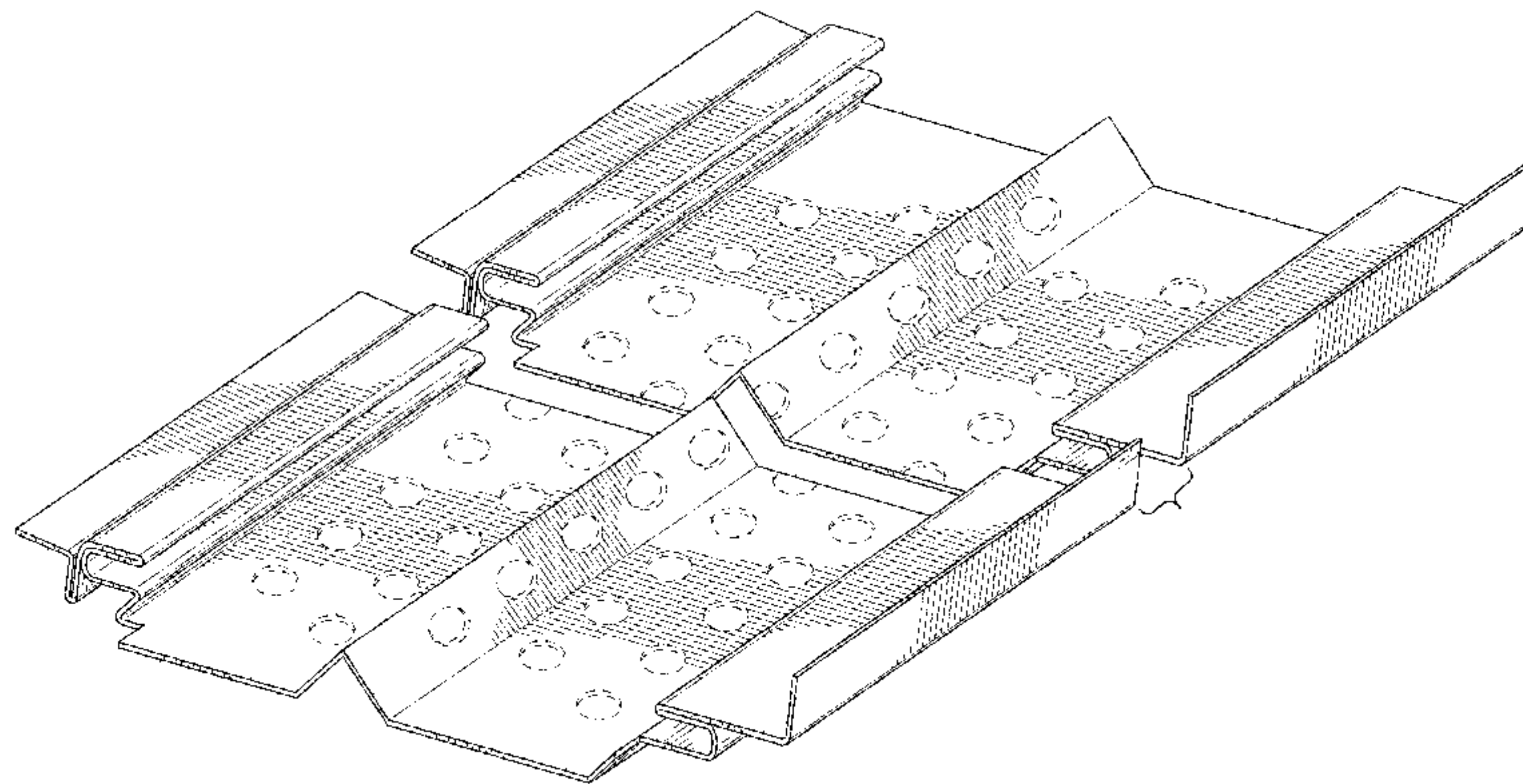

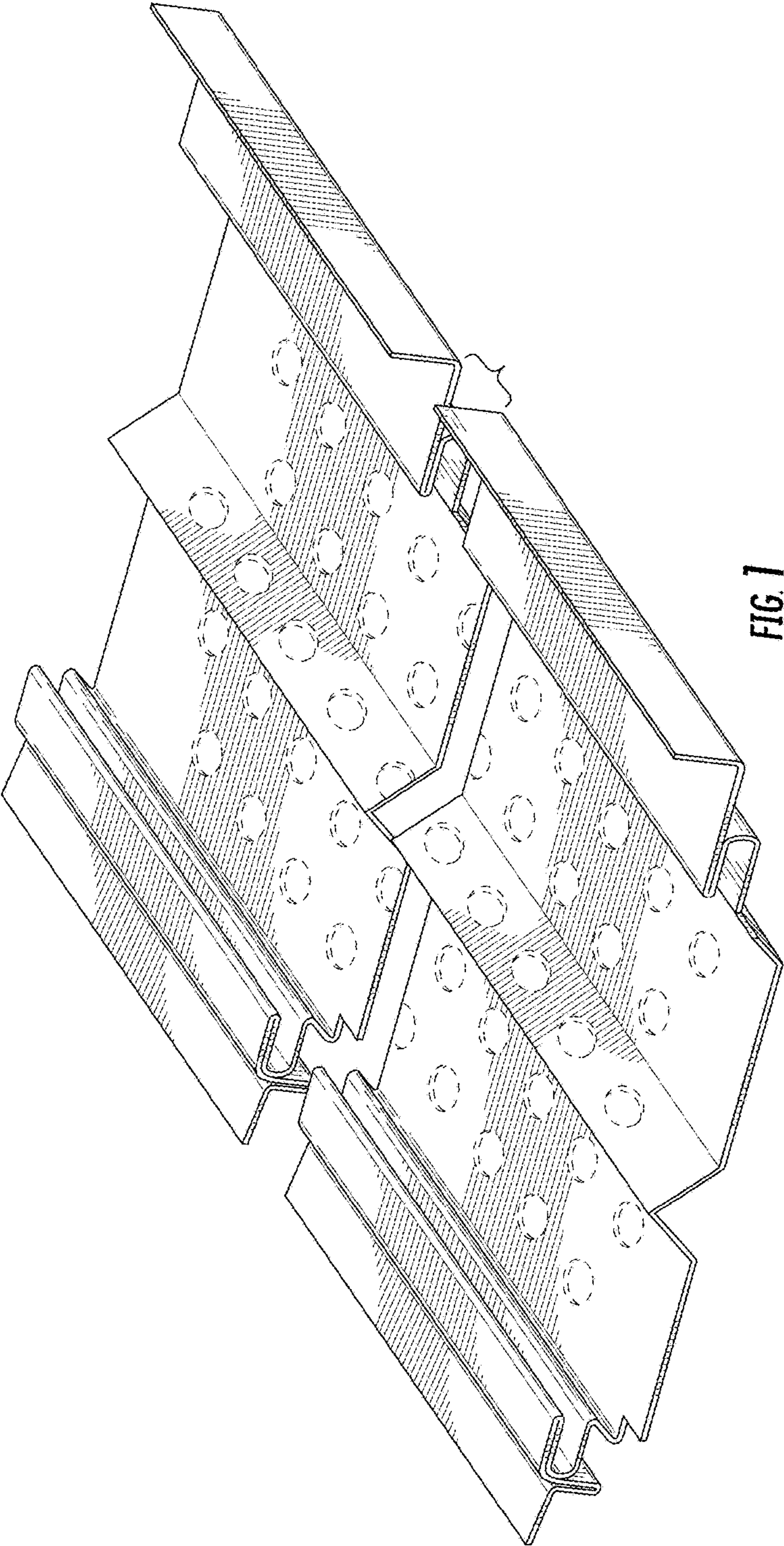

FIG. 1

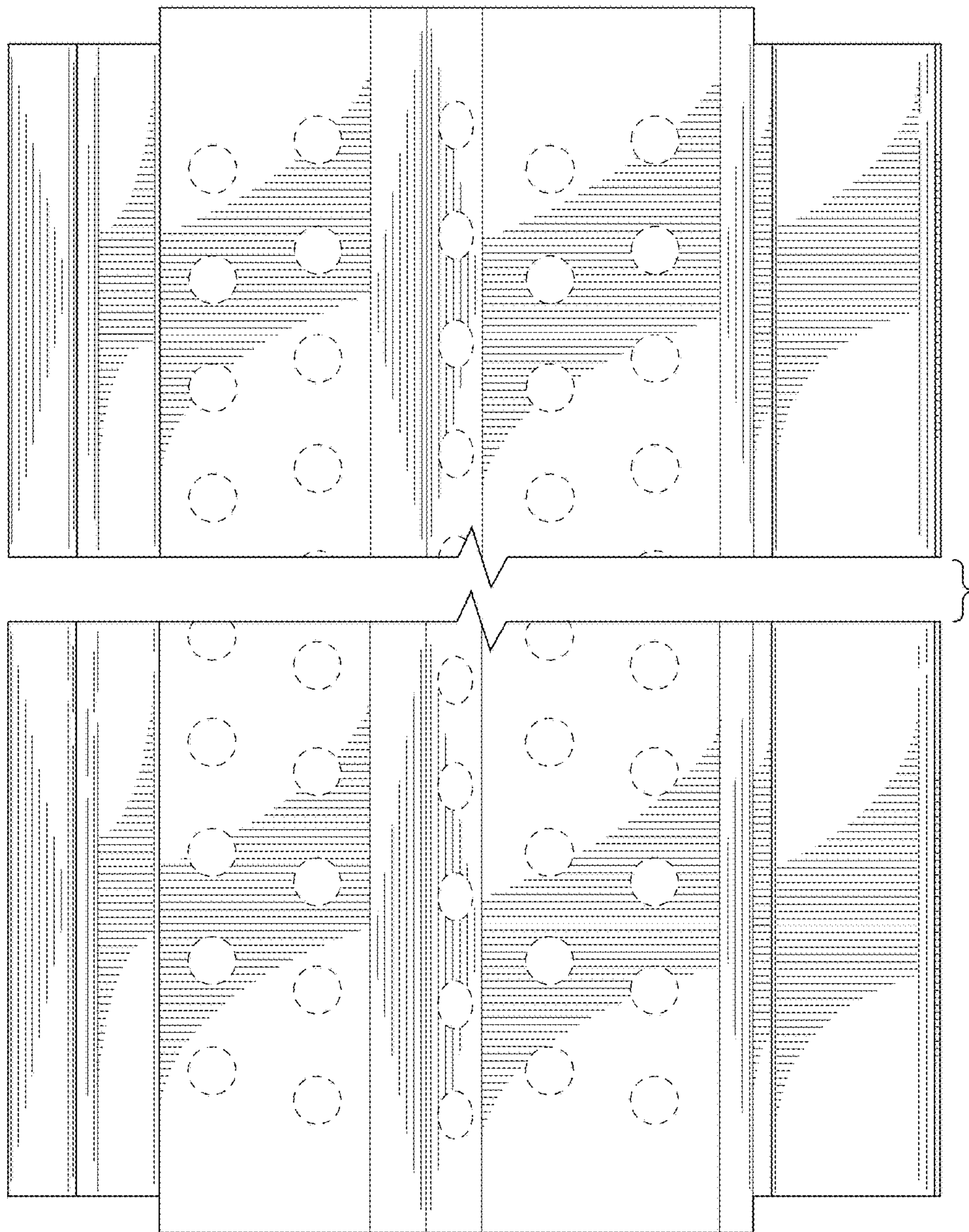

FIG. 2

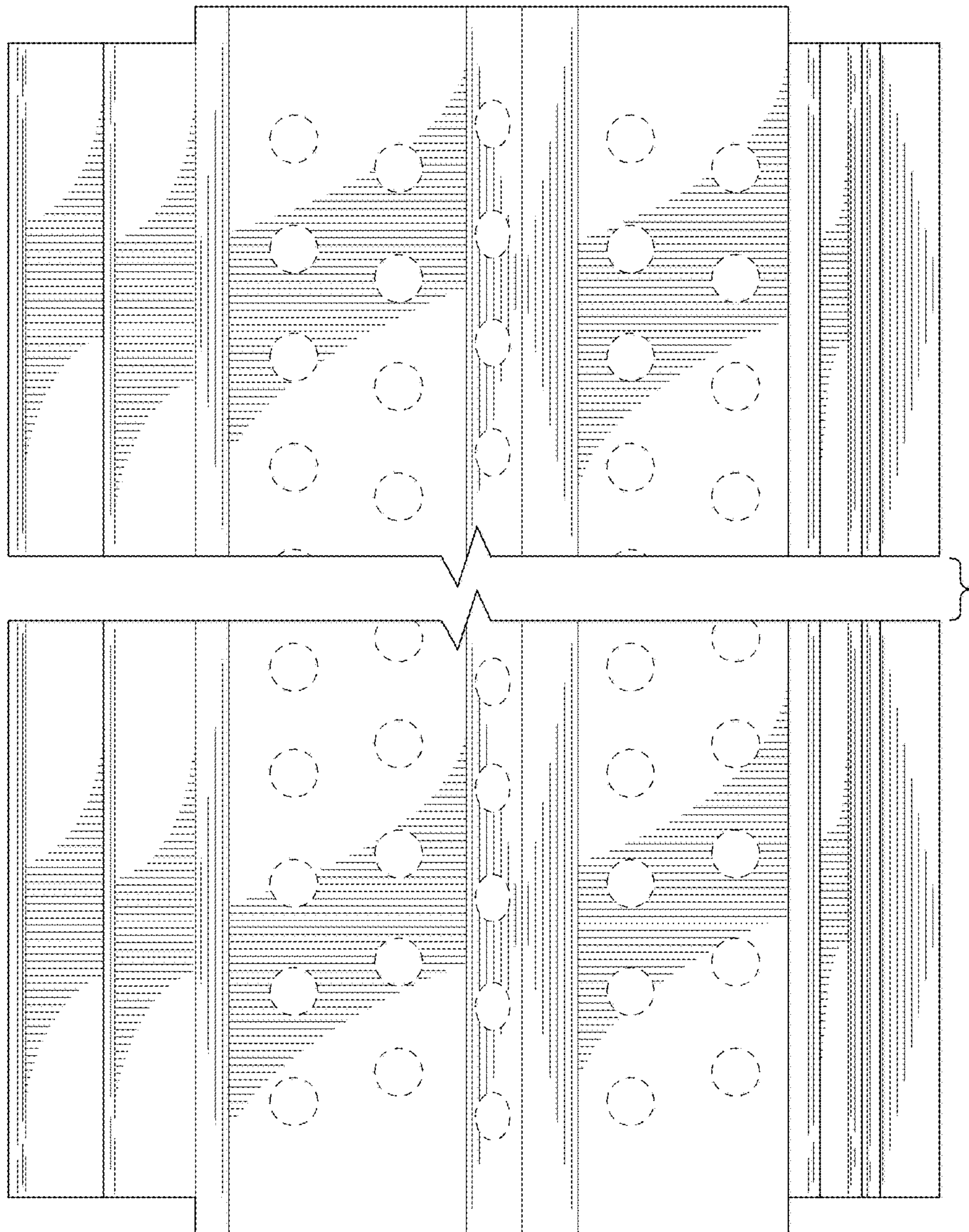

FIG. 3

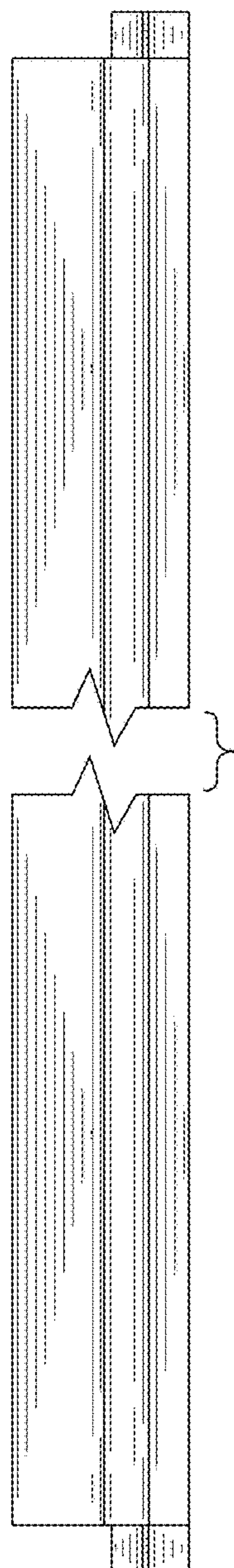

FIG. 4

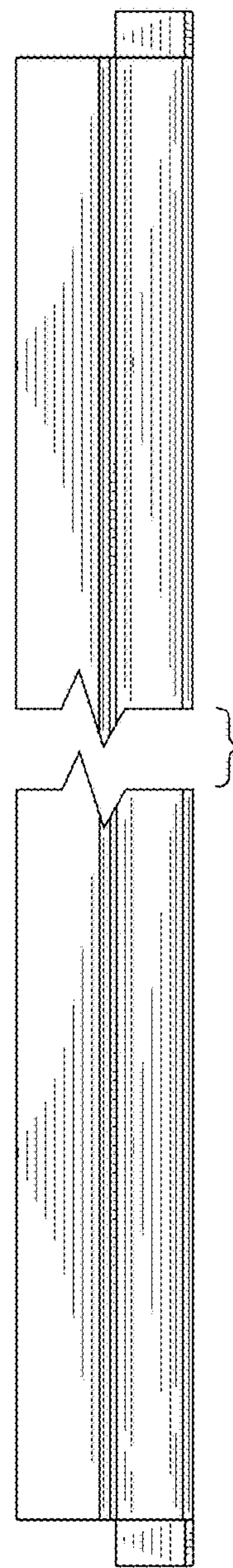

FIG. 5



FIG. 6

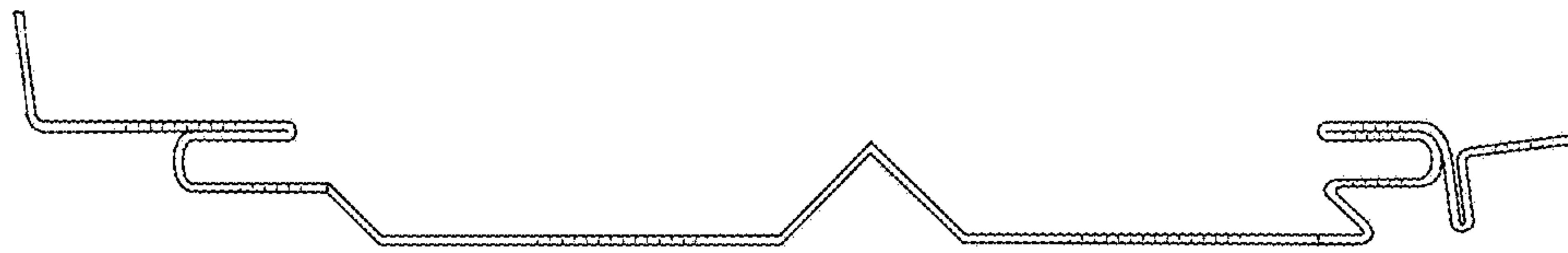

FIG. 7