



US00D853474S

(12) **United States Design Patent** (10) **Patent No.:** **US D853,474 S**
Cashman (45) **Date of Patent:** **** Jul. 9, 2019**

(54) **CAJON DRUM WITH REMOVABLE EXTERNAL SNARE**

Primary Examiner — Sheryl Lane
Assistant Examiner — Samantha N Wood
(74) *Attorney, Agent, or Firm* — Michael P. Alexander

(71) Applicant: **Carson J. Cashman**, Pittsburgh, PA (US)

(57) **CLAIM**

I claim the ornamental design for a cajon drum with removable external snare, as shown and described.

(72) Inventor: **Carson J. Cashman**, Pittsburgh, PA (US)

DESCRIPTION

(73) Assignee: **LUSON DRUMS, LLC**, Pittsburgh, PA (US)

FIG. 1 is a perspective view of the cajon drum with removable external snare showing our new design; FIG. 2 is a front view of the cajon drum with removable external snare of FIG. 1.

(**) Term: **15 Years**

FIG. 3 is a rear view of the cajon drum with removable external snare of FIG. 1.

(21) Appl. No.: **29/613,986**

FIG. 4 is a top view of the cajon drum with removable external snare of FIG. 1.

(22) Filed: **Aug. 15, 2017**

FIG. 5 is a bottom view of the cajon drum with removable external snare of FIG. 1.

(51) **LOC (11) Cl.** **17-04**

(52) **U.S. Cl.**

USPC **D17/22**

(58) **Field of Classification Search**

USPC D17/22, 23, 99; D9/759, 770, 432; D3/273, 274, 276, 900; D21/405, 406

(Continued)

FIG. 6 is a left side view of the cajon drum with removable external snare of FIG. 1.

FIG. 7 is a right side view of the cajon drum with removable external snare of FIG. 1, with an open sound hole.

FIG. 8 is a right side view of the cajon drum with removable external snare of FIG. 1, with a closed sound hole.

FIG. 9 is a perspective view of the removable external snare of FIG. 1;

(56) **References Cited**

U.S. PATENT DOCUMENTS

D298,951 S * 12/1988 Benson D17/22
D551,969 S * 10/2007 Aurilio D9/418

(Continued)

FIG. 10 is a front view of the removable external snare of FIG. 9.

FIG. 11 is a rear view of the removable external snare of FIG. 9.

FIG. 12 is a top view of the removable external snare of FIG. 9.

FIG. 13 is a bottom view of the removable external snare of FIG. 9.

FOREIGN PATENT DOCUMENTS

CN 201530432199 * 11/2015

FIG. 14 is a left side view of the removable external snare of FIG. 9; and,

FIG. 15 is a right side view of the removable external snare of FIG. 9.

OTHER PUBLICATIONS

Youtube, CajonTab with floating external snare mechanism, posted Apr. 13, 2017, [online], [visited Mar. 7, 2019]. Internet, <URL:https://www.youtube.com/watch?v=6YRD5RKac4Q> (Year: 2017).*

The broken lines are included for the purpose of illustrating the environmental structure and form no part of the claimed design.

(Continued)

1 Claim, 9 Drawing Sheets

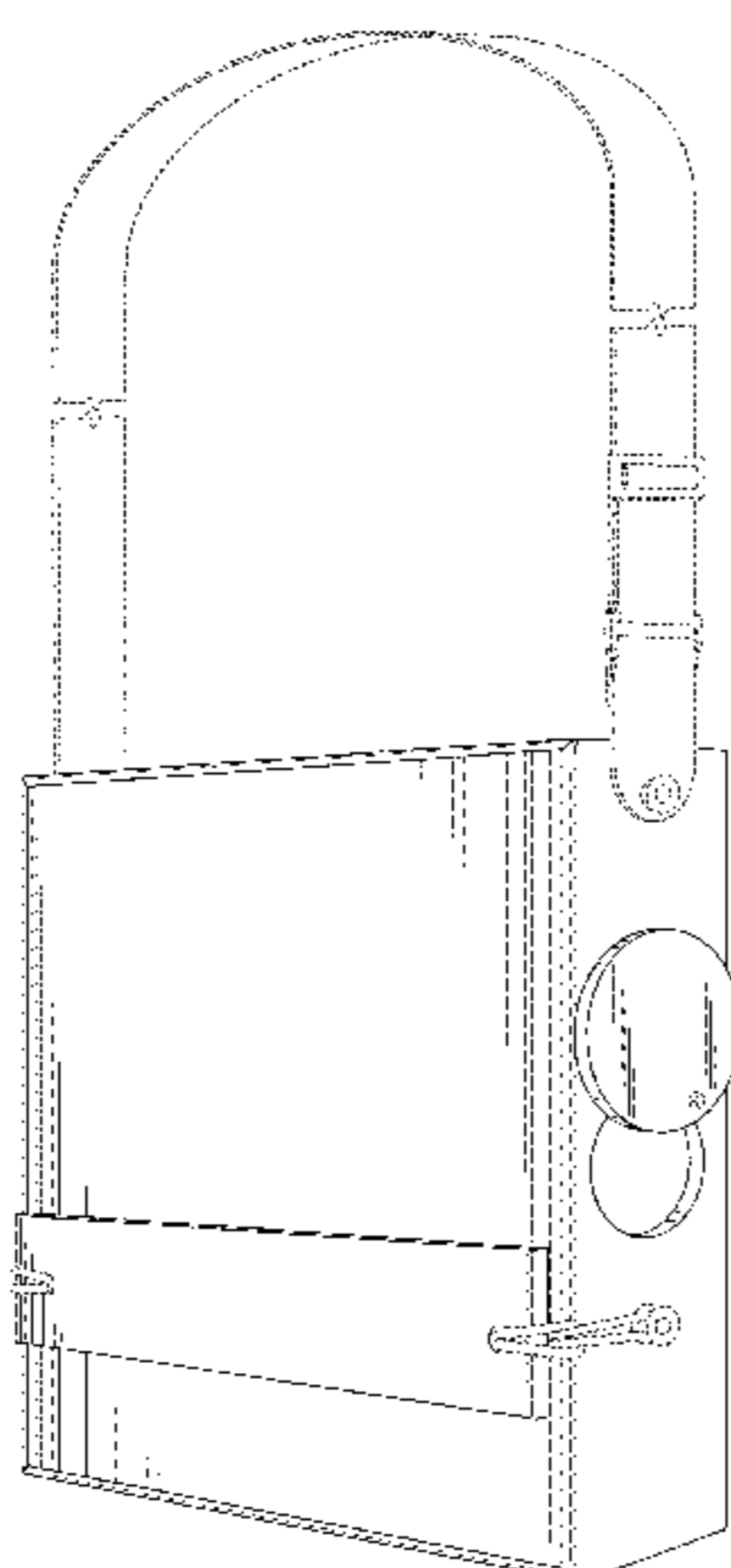

(58) **Field of Classification Search**

CPC G10D 13/00; G10D 13/02; G10D 13/025;
G10D 13/06; G10D 13/08

See application file for complete search history.

(56) **References Cited**

U.S. PATENT DOCUMENTS

D552,984 S * 10/2007 Baron D9/418
D729,060 S * 5/2015 Trombetta D9/418
D772,334 S * 11/2016 Nishi D17/22
D780,835 S * 3/2017 Drushal D17/20
D798,703 S * 10/2017 Hainaut D9/418
D836,160 S * 12/2018 Turner D17/22
2013/0112061 A1 * 5/2013 Ehmann G10D 13/025
84/415
2016/0140940 A1 * 5/2016 Sprengel G10D 7/00
84/170
2016/0335991 A1 * 11/2016 Amos G10D 13/00

OTHER PUBLICATIONS

Youtube, Tycoon Percussion Portable Cajon Practice Pad, posted Sep. 30, 2015, [online], [visited Mar. 7, 2019]. Internet, <URL: <https://www.youtube.com/watch?v=MGpQ6S7c-LI>> (Year: 2015).*

Youtube, How to make a mini Cajon, posted Apr. 18, 2014, [online], [visited Mar. 7, 2019]. Internet, <URL: <https://www.youtube.com/watch?v=CXGzTy2AqFI>> (Year: 2014).*

Prodrumblog, A Simple Hand Drum, posted Oct. 12, 2016, [online], [visited Mar. 7, 2019]. Internet, <URL: <http://prodrumblog.com/simple-hand-drum-caj%C3%B3ntab-louison-drums>> (Year: 2016).*

* cited by examiner

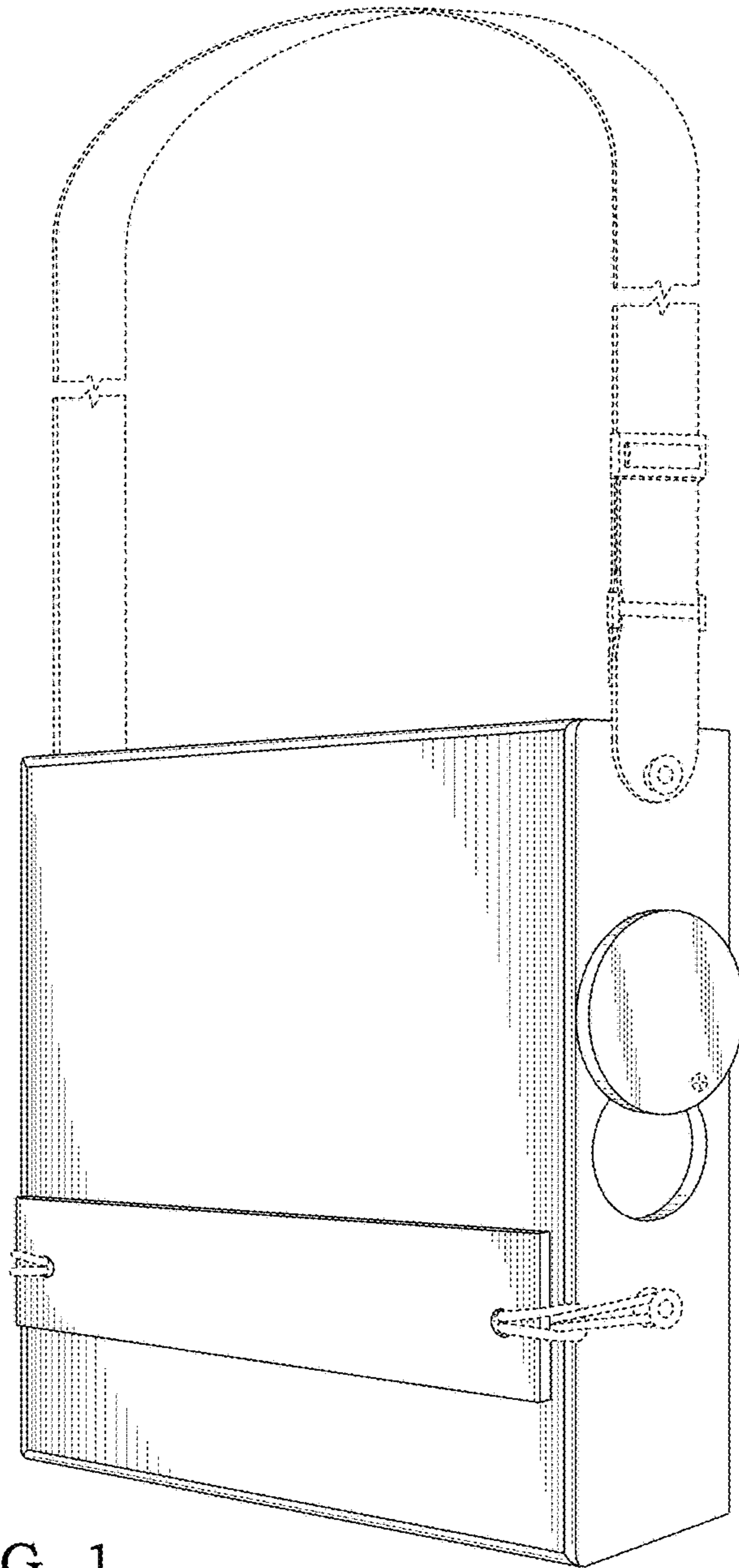

FIG. 1

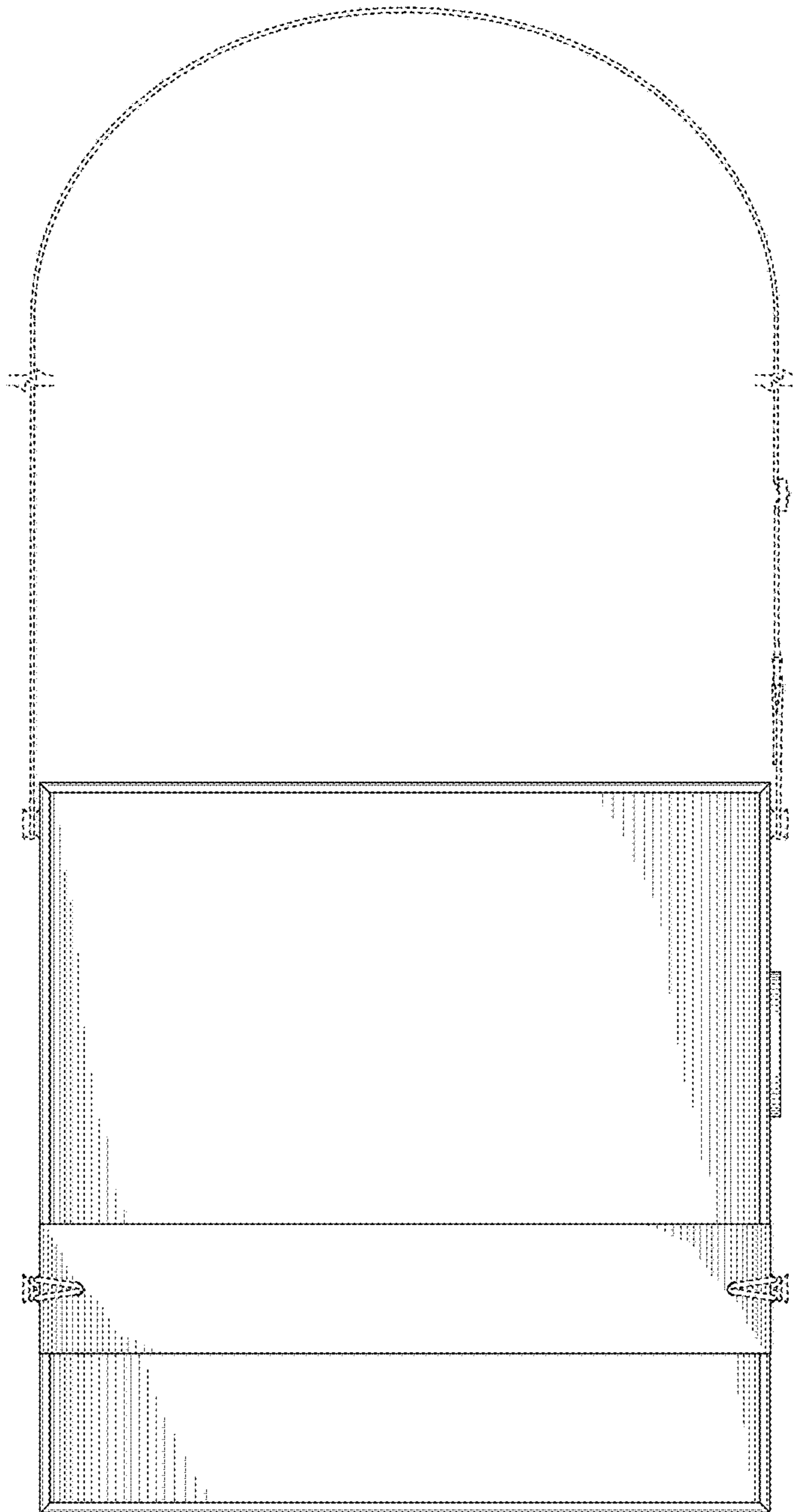

FIG. 2

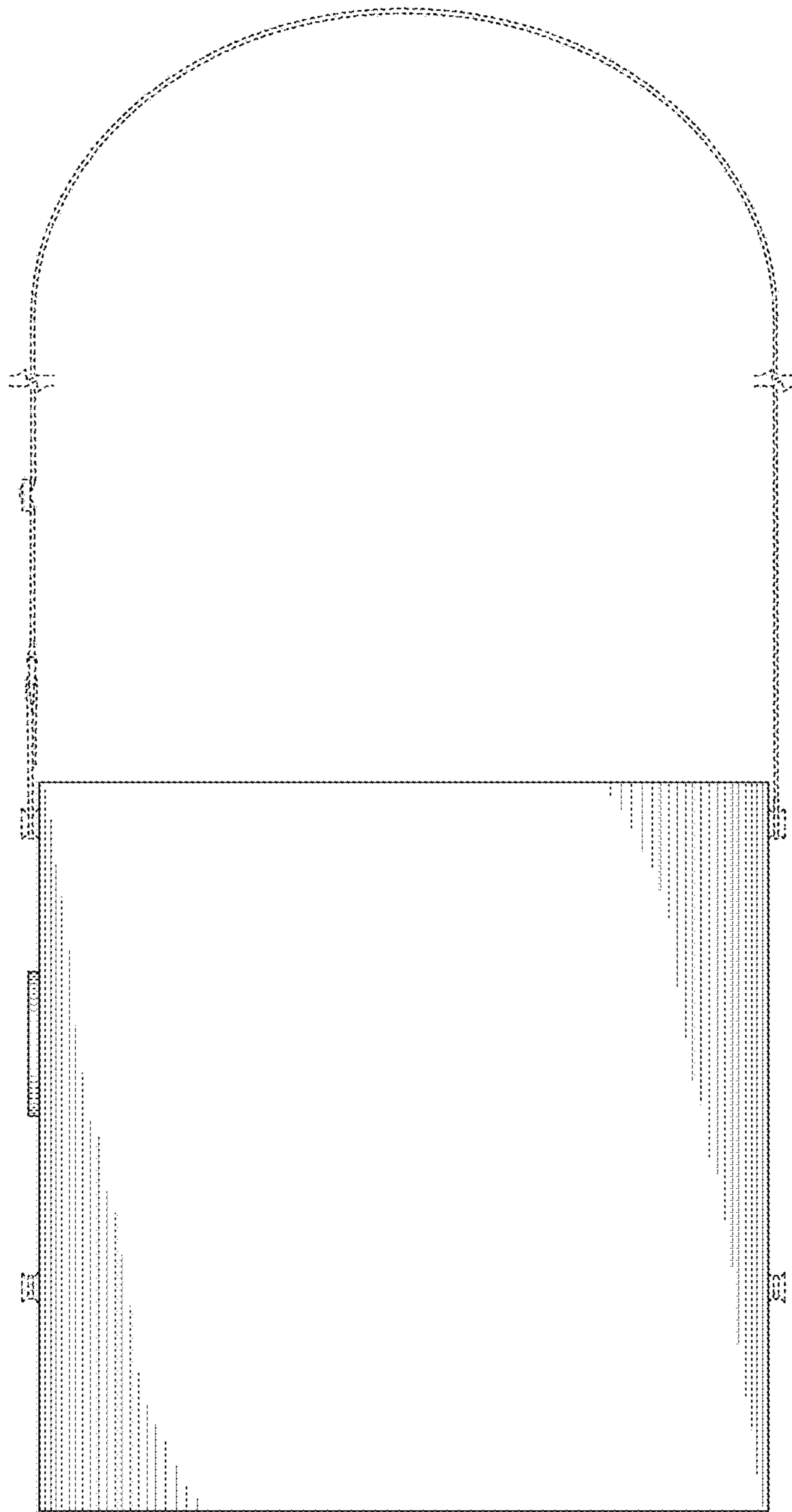

FIG. 3

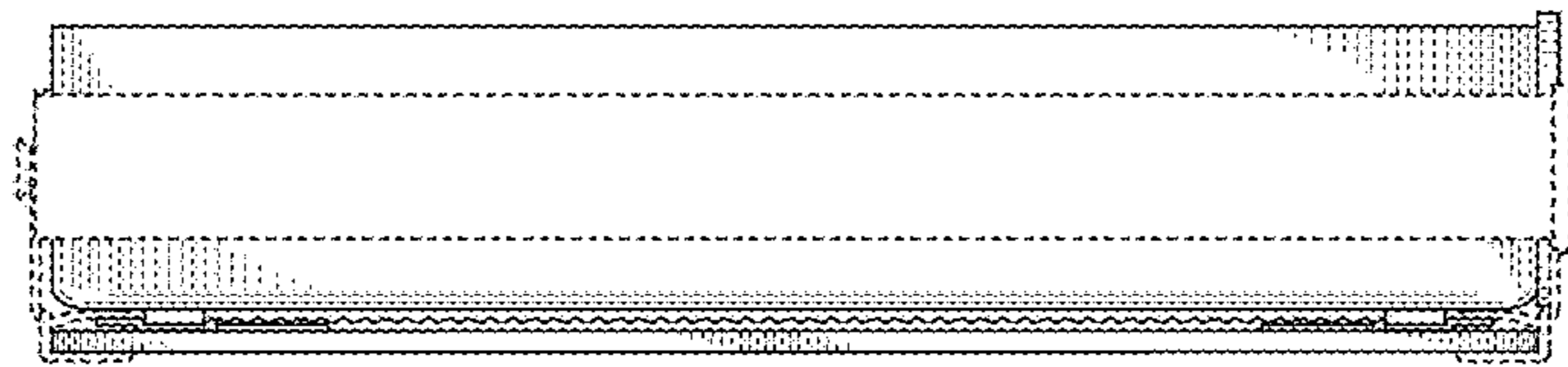

FIG. 4

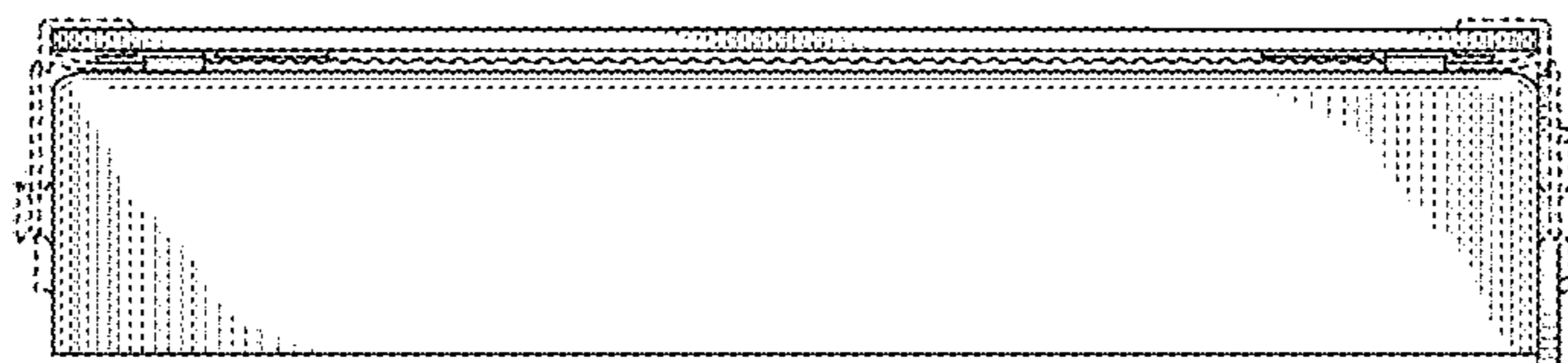

FIG. 5

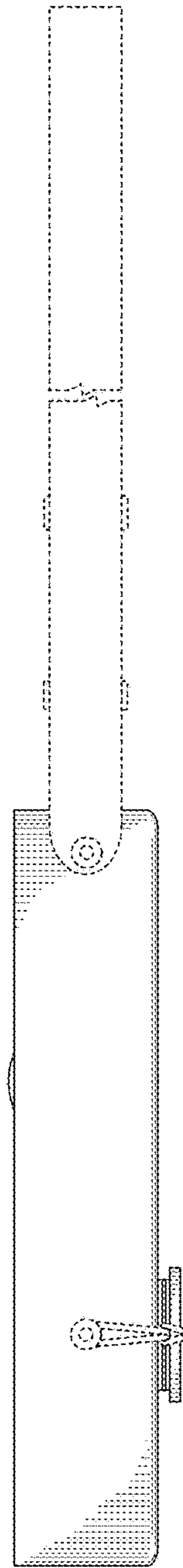

FIG. 6

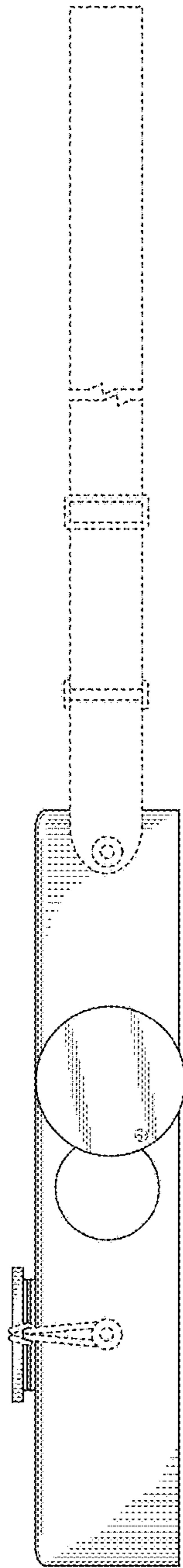

FIG. 7

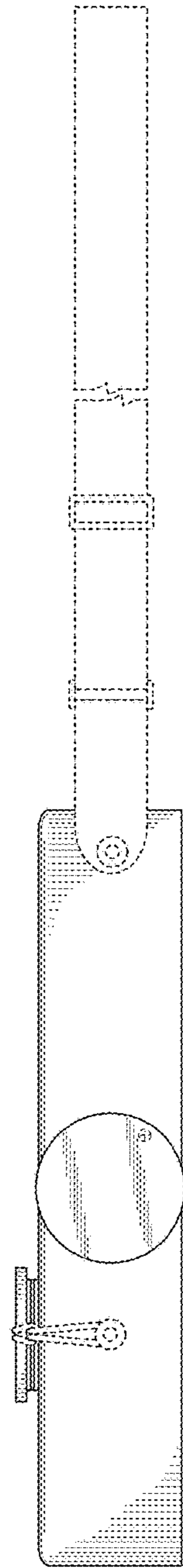

FIG. 8

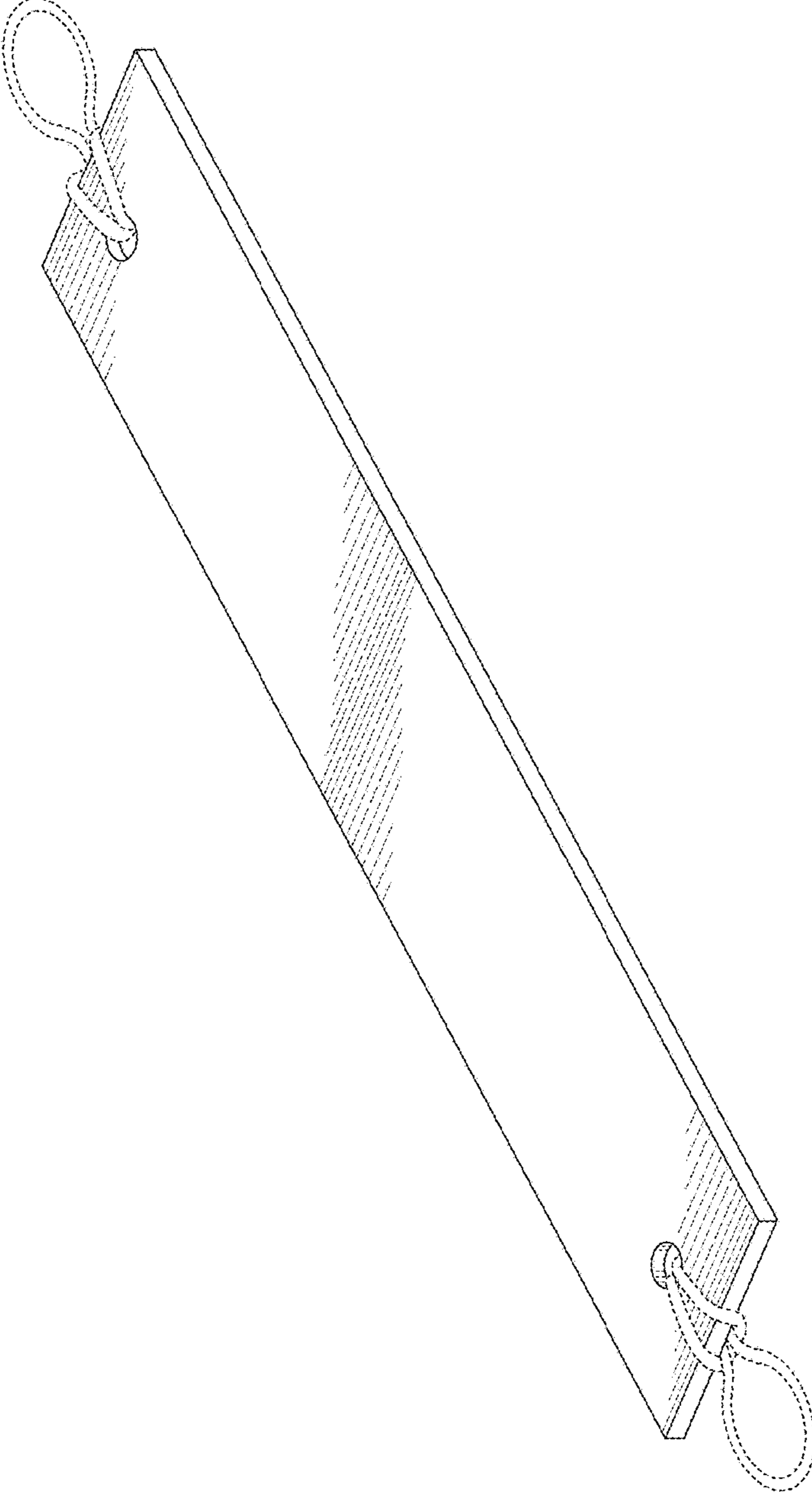

FIG. 9

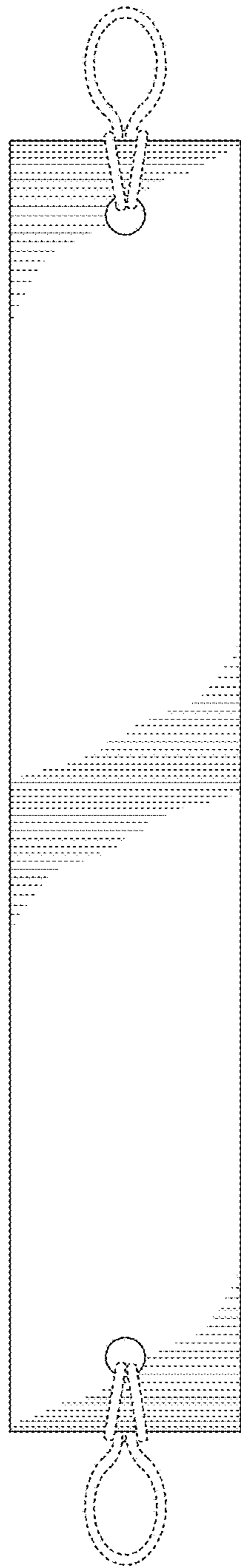

FIG. 10

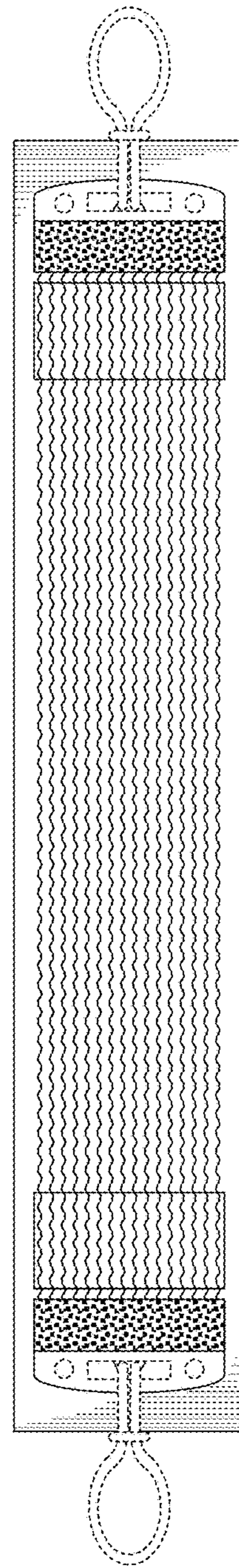

FIG. 11

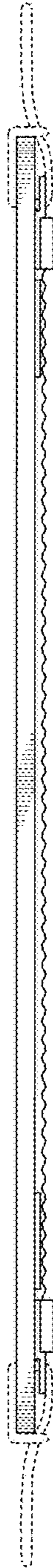

FIG. 12

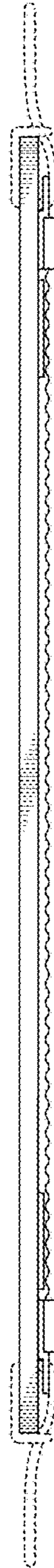

FIG. 13

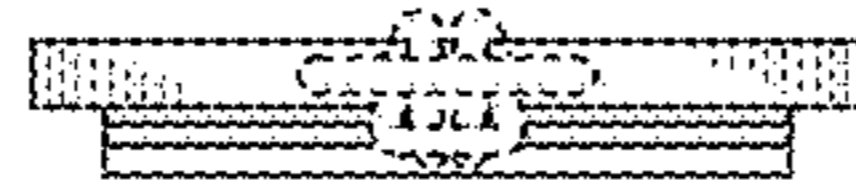

FIG. 14

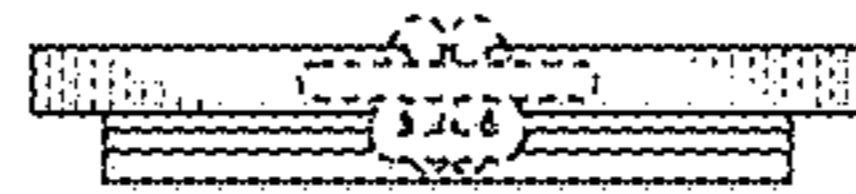

FIG. 15