



US00D853369S

(12) **United States Design Patent** (10) **Patent No.:** **US D853,369 S**
Jang et al. (45) **Date of Patent:** **** Jul. 9, 2019**

(54) **REPEATER FOR COMMUNICATIONS APPARATUS**

FOREIGN PATENT DOCUMENTS

(71) Applicant: **Samsung Electronics Co., Ltd.**,
Suwon-si (KR)

EM 001399075-0002 2/2014
JP D1581530 * 7/2017

(Continued)

(72) Inventors: **Moonjung Jang**, Gunpo-si (KR);
Soyoon Jeon, Guri-si (KR)

OTHER PUBLICATIONS

(73) Assignee: **Samsung Electronics Co., Ltd.**,
Suwon-si (KR)

Amazon. <URL: [\(**\) Term: **15 Years**](https://www.amazon.com/dp/B00VWA2QD6/ref=sspa_dk_detail_2psc=1&pd_rd_i=B00VWA2QD6&pd_rd_wg=aW9qE&pd_rd_r=6VJEWYTX2MFDBYS1PVCJ&pd_rd_w=7xPrZ.>Mar. 2, 2016. SureCall Signal Booster Amplifier Kit.*</p></div>
<div data-bbox=)

Primary Examiner — Bridget L Eland
Assistant Examiner — Lauren D McVey
(74) *Attorney, Agent, or Firm* — NSIP Law

(21) Appl. No.: **29/604,848**

(22) Filed: **May 22, 2017**

(57) **CLAIM**

(30) **Foreign Application Priority Data**

We claim the ornamental design for a repeater for communications apparatus, as shown and described.

Jan. 18, 2017 (KR) 30-2017-0003175

DESCRIPTION

(51) **LOC (11) Cl.** **14-03**

(52) **U.S. Cl.**
USPC **D14/242**

(58) **Field of Classification Search**
USPC D14/242, 240, 355, 357, 358, 125,
D14/140-140.9, 155, 137, 139, 243, 239,
D14/433, 496, 188, 348, 351, 356
CPC H04L 12/00; H03K 17/00; H04W 88/00;
H04W 88/005; H04W 88/02; H04W
88/08; H04W 88/085; H04W 88/10;
H04W 88/12; H04W 88/14; H04B 1/38
See application file for complete search history.

FIG. 1 is a front perspective view of a repeater for communications apparatus showing our new design; FIG. 2 is a front elevational view thereof; FIG. 3 is a rear elevational view thereof; FIG. 4 is a left-side elevational view thereof; FIG. 5 is a right-side elevational view thereof; FIG. 6 is a top plan view thereof; FIG. 7 is a bottom plan view thereof; and, FIG. 8 is an enlarged view of the encircled portion in FIG. 1.

The broken lines in the figures depict environmental subject matter and form no part of the claimed design. The dot-dash broken lines in the figures illustrate a boundary of the claimed design and form no part thereof. The dot-dot-dash broken lines encircling portions of the claimed design that are illustrated in enlargements form no part of the claimed design. The unshaded surface that directly adjoins the solid line edge forms no part of the claimed design.

(56) **References Cited**

U.S. PATENT DOCUMENTS

D287,888 S * 1/1987 Castor D23/371
D403,666 S * 1/1999 Maack D13/179
D437,592 S * 2/2001 DeLeon D14/242

(Continued)

1 Claim, 8 Drawing Sheets

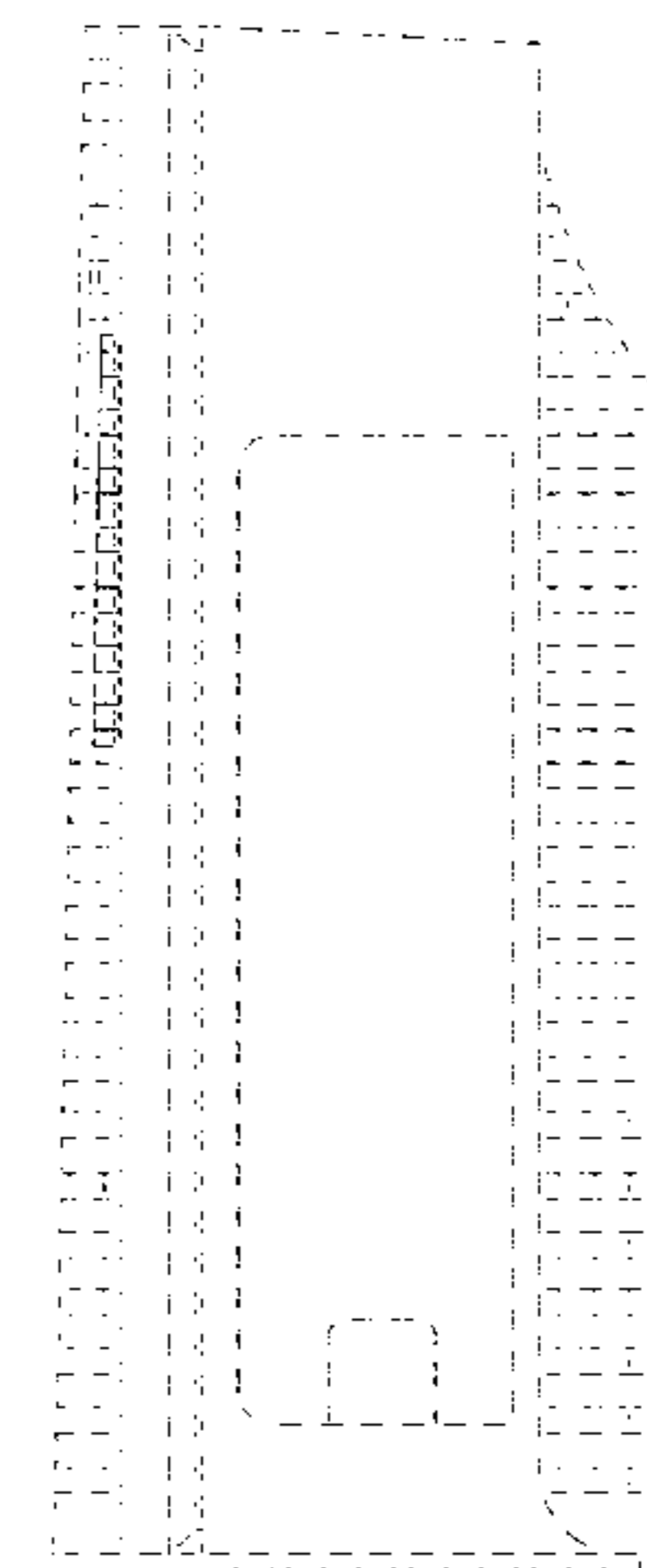
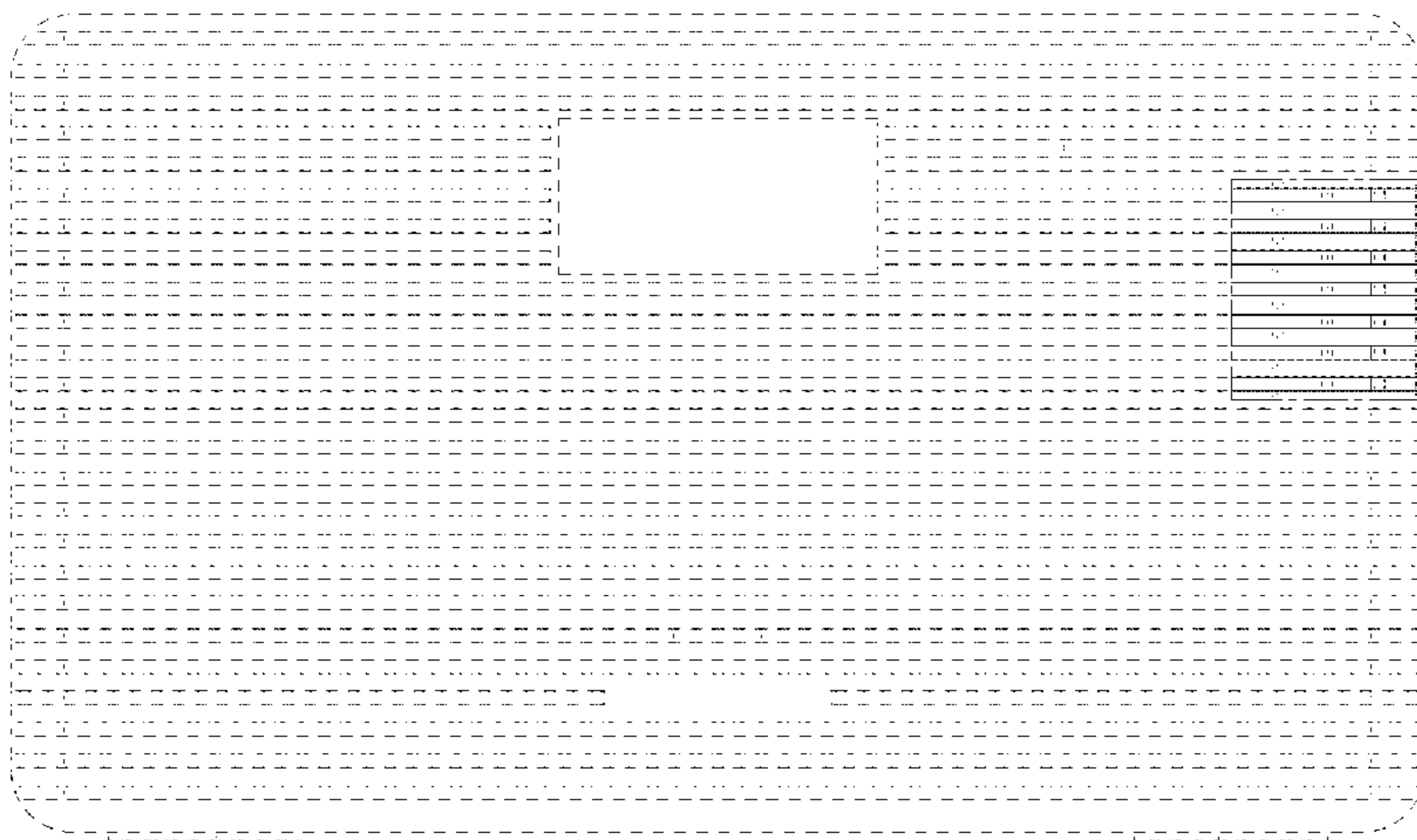

(56)

References Cited

U.S. PATENT DOCUMENTS

6,397,941 B1 * 6/2002 McCullough F28D 15/0275
165/104.33
D486,830 S * 2/2004 Kadonaga D13/182
D499,074 S * 11/2004 Cook D13/179
D595,292 S * 6/2009 Harden D14/240
D595,293 S * 6/2009 Harden D14/240
D610,125 S 2/2010 Ichikawa et al.
D620,017 S * 7/2010 Lo D14/480.7
D655,280 S * 3/2012 MacManus D14/140.1
D663,293 S * 7/2012 MacManus D14/140.1
D733,107 S * 6/2015 Porter D14/240
D784,970 S * 4/2017 MacManus D14/240
D809,515 S * 2/2018 Nada D14/356

FOREIGN PATENT DOCUMENTS

KR 300912662.0000 * 6/2017
KR 300912664.0000 * 6/2017
KR 300912666.0000 * 6/2017
KR 300916729.0000 * 7/2017
KR 300938856.0000 * 1/2018

* cited by examiner

FIG. 1

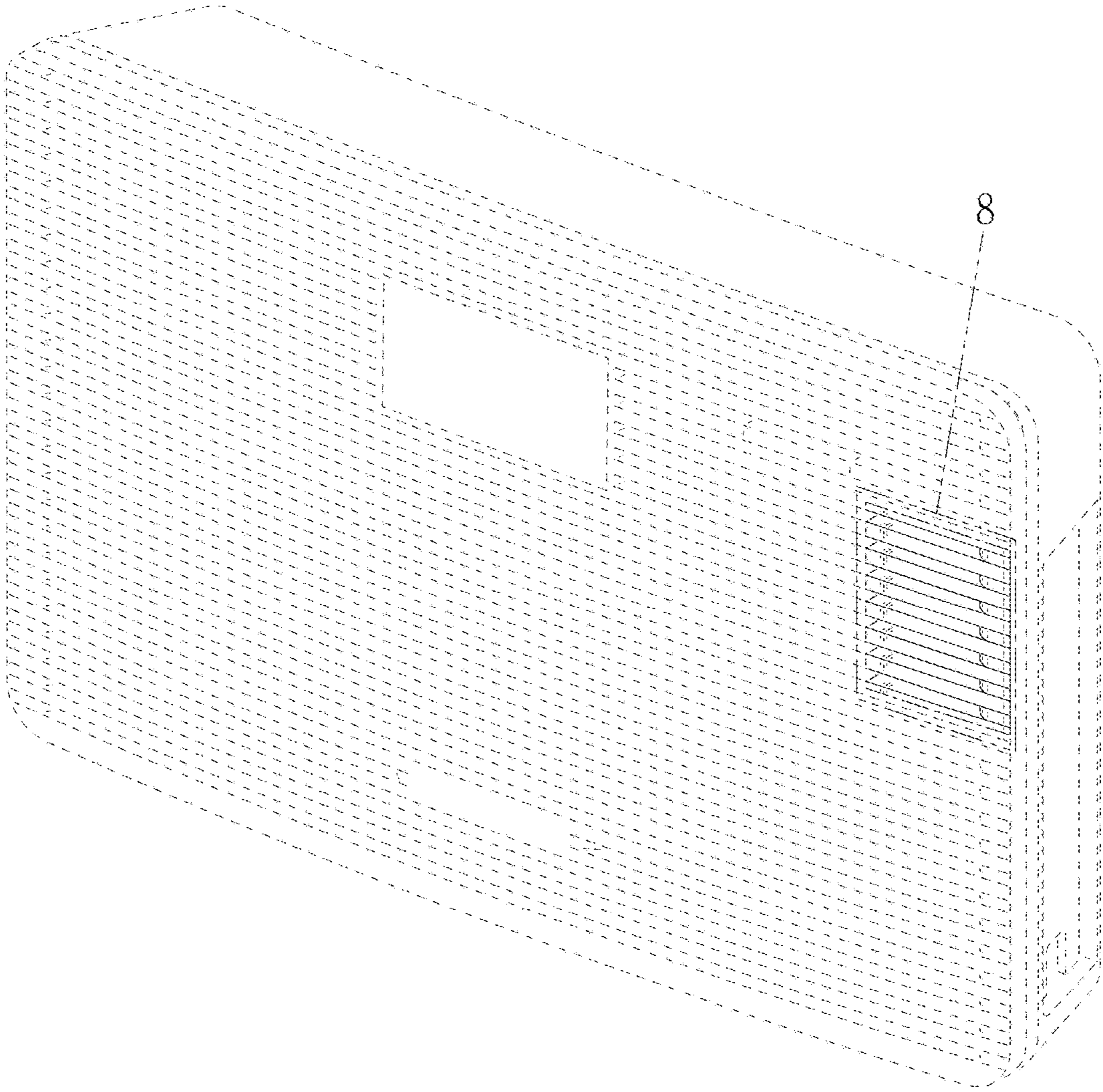

FIG. 2

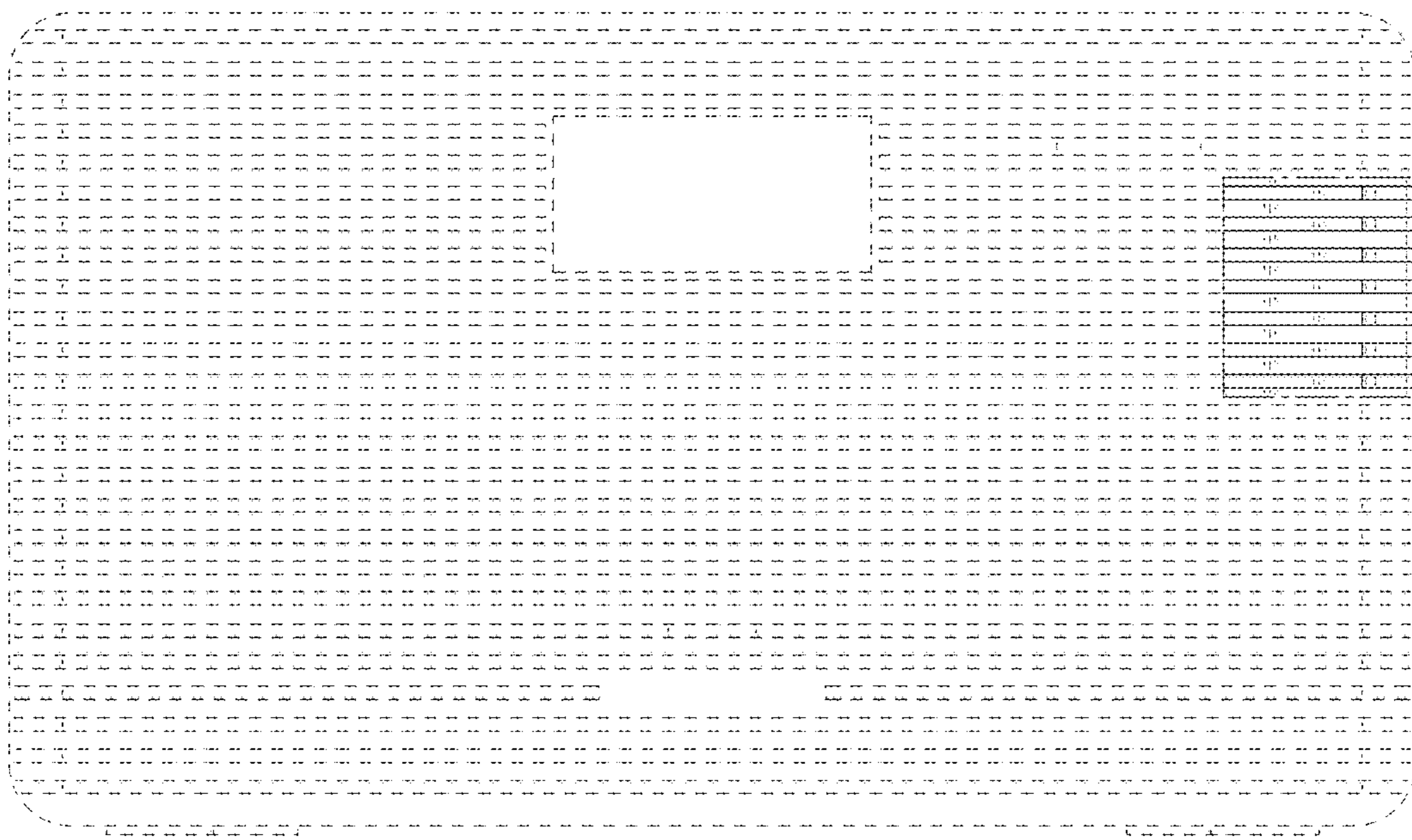

FIG. 3

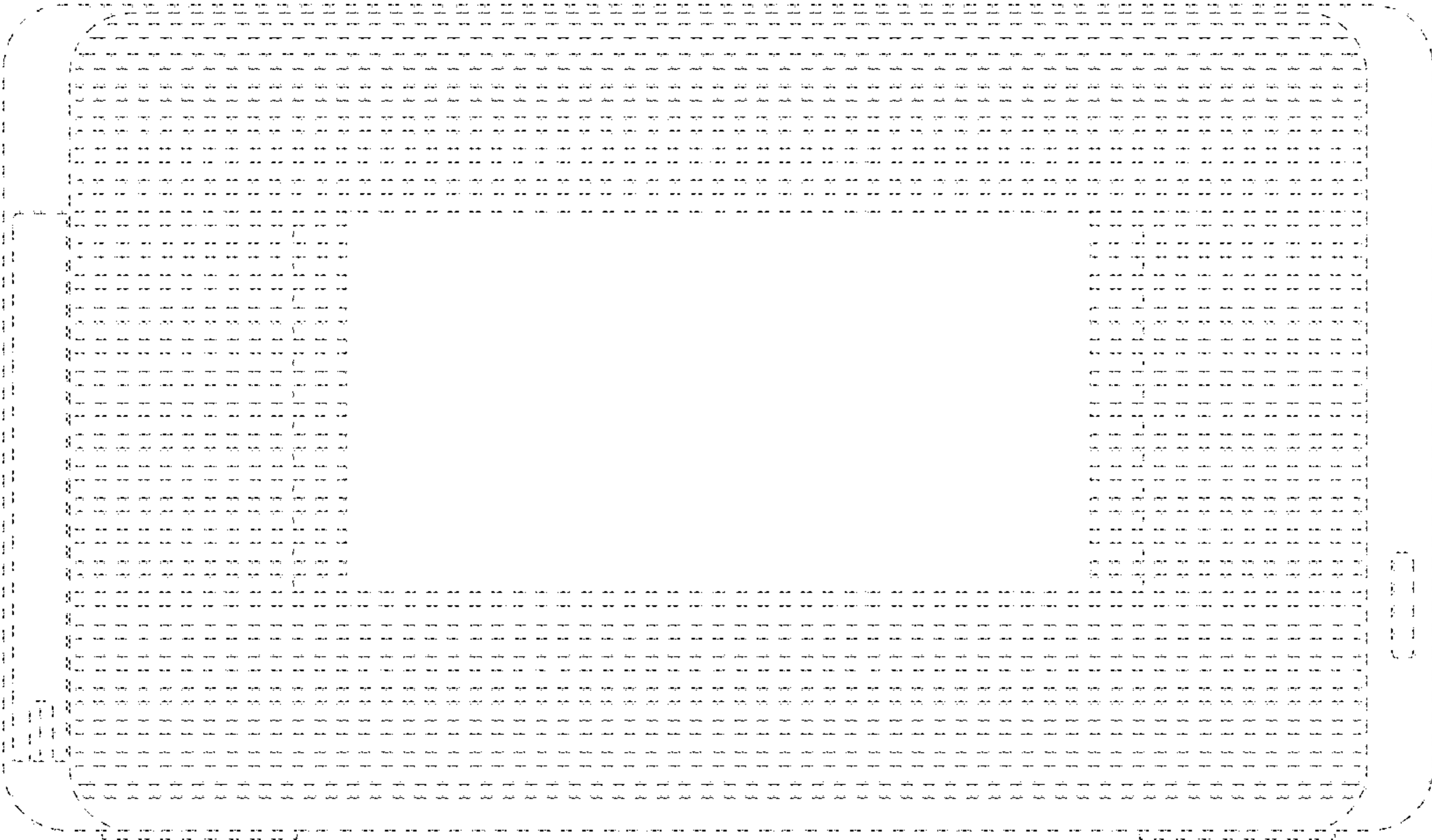

FIG. 4

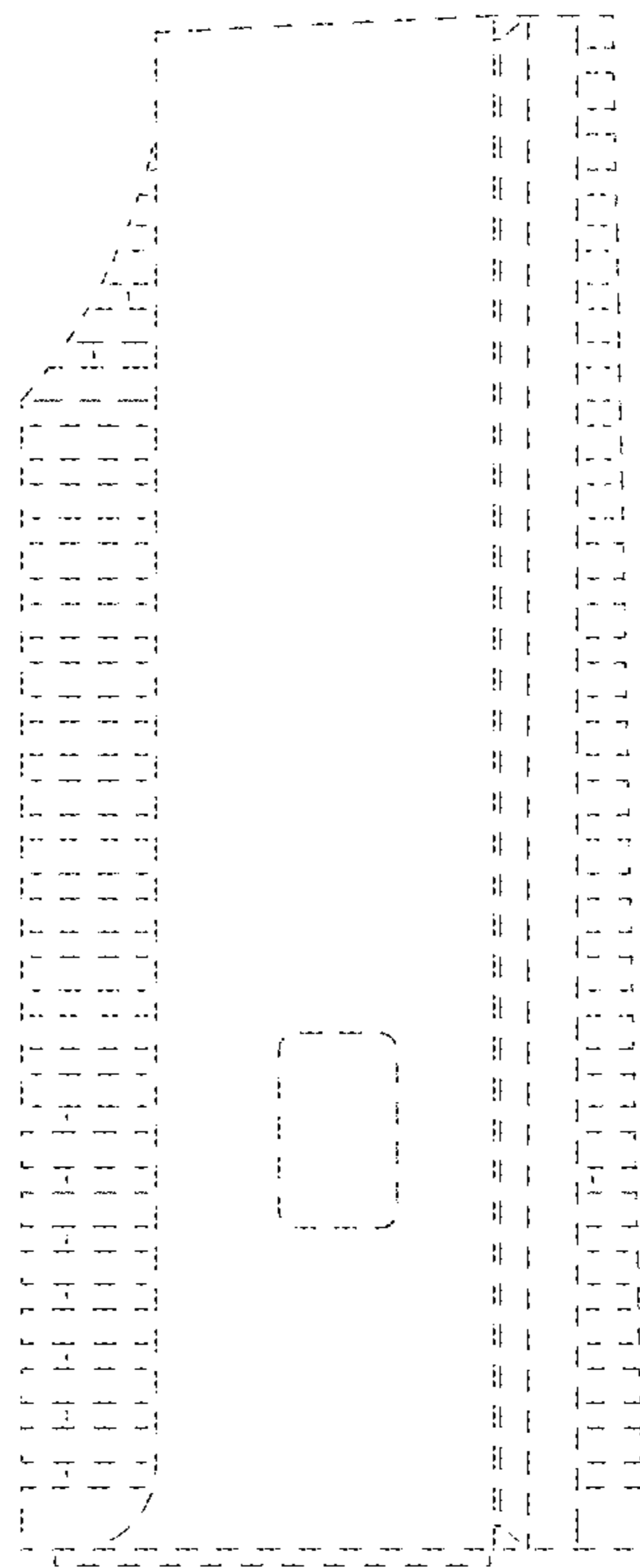

FIG. 5

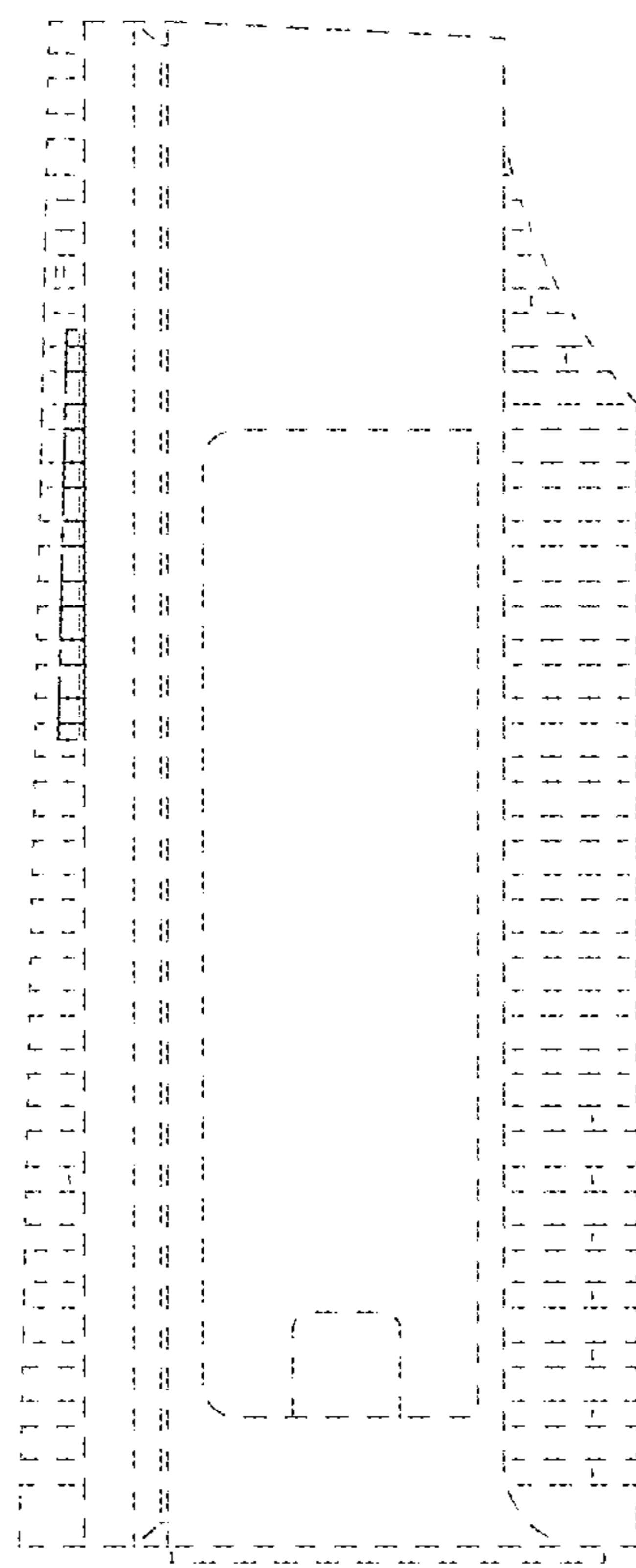

FIG. 6

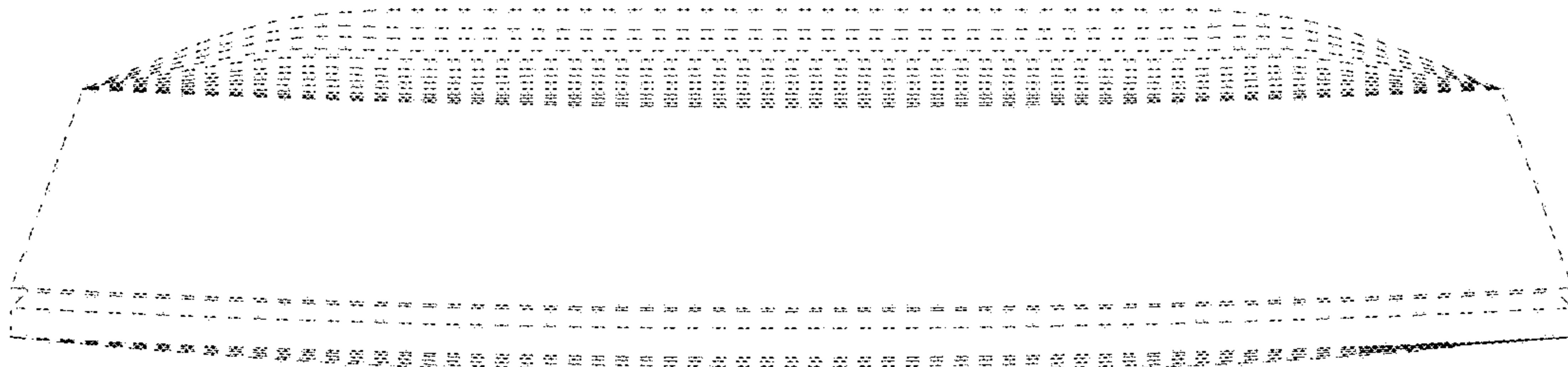

FIG. 7

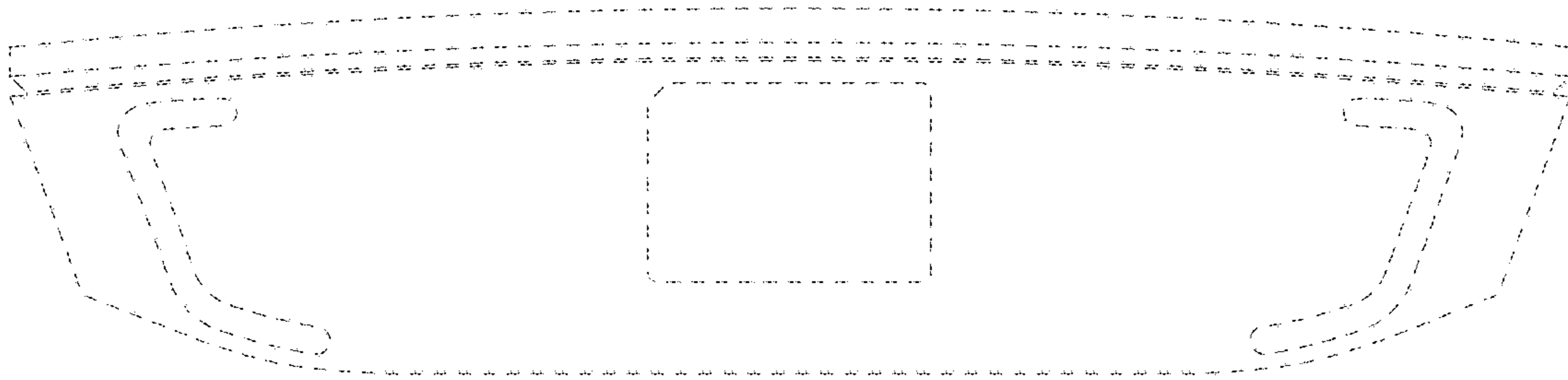

FIG. 8

