



US00D853350S

(12) **United States Design Patent** (10) **Patent No.:** **US D853,350 S**
Lindén et al. (45) **Date of Patent:** **** Jul. 9, 2019**

(54) **PAIR OF EARPHONES AND CASING**

(71) Applicant: **Earin AB**, Malmö (SE)

(72) Inventors: **Olle Lindén**, Malmö (SE); **Fredrik Möller**, Malmö (SE); **Mathias Walter**, Malmö (SE); **Carl Forslund**, Malmö (SE)

(73) Assignee: **Earin AB**, Malmö (SE)

(**) Term: **15 Years**

(21) Appl. No.: **29/609,634**

(22) Filed: **Jul. 3, 2017**

(30) **Foreign Application Priority Data**

Jan. 3, 2017 (EM) 003566918

(51) **LOC (11) Cl.** **14-01**

(52) **U.S. Cl.**
USPC **D14/205; D14/223**

(58) **Field of Classification Search**
USPC D14/205, 223; D3/218, 206; D13/103;
429/159, 99; D24/106; 181/129, 130,
(Continued)

(56) **References Cited**

U.S. PATENT DOCUMENTS

D18,003 S * 1/1888 Osborn D19/187
1,668,910 A * 5/1928 Jones H04R 1/1016
181/130

(Continued)

OTHER PUBLICATIONS

Earin, "The Worlds's Smallest Wireless Earbuds", [retrieved on Jul. 24, 2015]. Retrieved from the Internet:<URL:<<http://www.earin.com/>>(undated) 1 page. Product publicly available prior to Jun. 29, 2015. (Year: 2015).*

Primary Examiner — Paula Allen Greene

(74) *Attorney, Agent, or Firm* — Capitol City TechLaw

(57) **CLAIM**

The ornamental design for a pair of earphones and casing, as shown and described.

DESCRIPTION

FIG. 1 is a front, top, and right side perspective view of an earphone of a pair of earphones and casing showing our new design, the earphone is shown separately for purposes of illustration;

FIG. 2 is a bottom view thereof;

FIG. 3 is a left side view thereof;

FIG. 4 is a front view thereof;

FIG. 5 is a right side view thereof;

FIG. 6 is a top view thereof;

FIG. 7 is a rear view thereof;

FIG. 8 is a front, top, and right side perspective view of a pair of earphones and casing showing our new design, with the casing in an opened condition and holding two earphones;

FIG. 9 is a rear view thereof;

FIG. 10 is a right side view thereof;

FIG. 11 is a bottom view thereof;

FIG. 12 is a front view thereof;

FIG. 13 is a top view thereof;

FIG. 14 is a left side view thereof;

FIG. 15 is a front, top, and right side perspective view of a casing for a pair of earphones and casing showing our new design, with the casing in a closed condition, the casing is shown separately for purposes of illustration;

FIG. 16 is a top view thereof;

FIG. 17 is a front view thereof;

FIG. 18 is a right side view thereof, the left side view being a mirror image thereof;

FIG. 19 is a rear, bottom, and right side perspective view thereof; and,

FIG. 20 is a bottom view thereof.

1 Claim, 11 Drawing Sheets

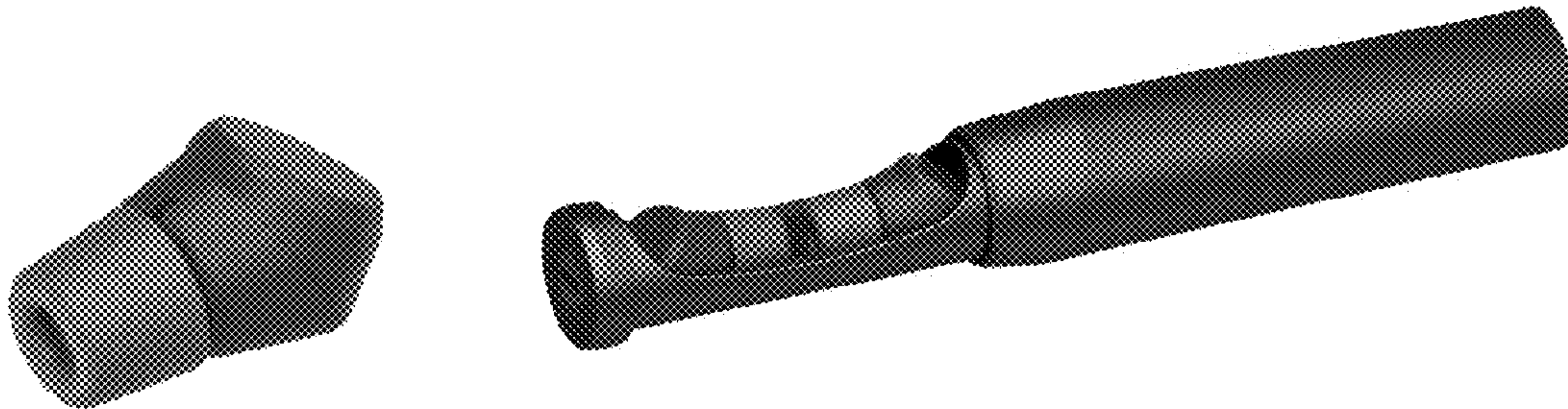

(58) **Field of Classification Search**

USPC 181/135; 379/428.01, 430, 431;
 381/380, 381, 309, 384, 74, 322, 323,
 381/328, 330, 332; 24/11 R; 455/557,
 455/90.3, 575.1, 569.1; 710/303;
 206/523, 224; 128/864, 865, 866
 CPC H04R 25/602; H04R 1/1033; H04R 1/10;
 H04R 25/00; H04R 1/1025; H04R 1/02
 See application file for complete search history.

(56) **References Cited**

U.S. PATENT DOCUMENTS

D98,095 S * 1/1936 Steckler D24/106
 2,358,339 A * 9/1944 Lucas B66C 23/48
 212/263
 2,670,737 A * 3/1954 Cantor A61F 11/08
 128/864
 2,697,128 A * 12/1954 Moore F21L 4/00
 362/198
 D182,820 S * 5/1958 Osborn D14/225
 2,934,160 A * 4/1960 Touson A61F 11/10
 181/130
 2,951,107 A * 8/1960 Abrams H01M 2/105
 248/224.8
 3,259,128 A * 7/1966 Leight A61F 11/08
 128/865
 3,575,725 A * 4/1971 Kaye H01M 2/105
 429/157
 3,859,140 A * 1/1975 Schmidt H01M 2/105
 429/99
 D235,483 S * 6/1975 Leight D24/106
 D259,279 S * 5/1981 Takeda D24/106
 4,265,984 A * 5/1981 Kaye H01M 2/105
 429/151
 4,314,553 A * 2/1982 Westerdal A61F 11/12
 128/201.18
 4,471,490 A * 9/1984 Bellafiore H04R 25/65
 29/460
 4,552,137 A * 11/1985 Strauss A61F 11/08
 128/864
 4,622,975 A * 11/1986 Danby A61B 5/042
 600/379
 4,648,013 A * 3/1987 Curiel F21L 4/08
 136/251
 D333,560 S * 3/1993 Miyashita D3/218
 5,434,374 A * 7/1995 Hsueh F01N 1/12
 181/227
 5,709,964 A * 1/1998 Christensen H01M 2/105
 429/153
 D413,379 S * 8/1999 Leight D24/106
 D435,036 S * 12/2000 Koss D14/223
 D468,301 S * 1/2003 Fushimi D14/223
 6,567,527 B1 * 5/2003 Baker H01M 2/0202
 381/322
 6,677,078 B2 * 1/2004 Reise H01M 2/105
 429/159
 6,830,124 B2 * 12/2004 Chiang A61F 11/08
 128/864
 7,010,137 B1 * 3/2006 Leedom A61B 5/6817
 381/322
 D532,372 S * 11/2006 Keating D13/108
 D573,588 S * 7/2008 Warren D14/225
 D584,398 S * 1/2009 Benner D24/106
 D587,681 S * 3/2009 Yanai D14/205
 D594,441 S * 6/2009 Lee D14/205
 D605,628 S * 12/2009 Ando D14/205

D606,971 S * 12/2009 Christopher D14/205
 D614,168 S * 4/2010 Rogers D14/206
 D621,389 S * 8/2010 Nagayama D14/223
 D639,280 S * 6/2011 Hayes D14/223
 D652,817 S * 1/2012 Lee D14/205
 D654,056 S * 2/2012 Hoggarth D14/205
 8,275,166 B2 * 9/2012 Wu H04R 25/00
 381/328
 8,515,103 B2 * 8/2013 Mei H04R 1/1016
 381/309
 8,609,265 B2 * 12/2013 Hong H01M 2/105
 174/257
 8,609,266 B2 * 12/2013 Ahn H01M 2/204
 174/257
 D699,226 S * 2/2014 Yoon D14/206
 8,731,227 B2 * 5/2014 Hwang H04R 1/1091
 181/135
 D711,858 S * 8/2014 Yang D14/223
 8,867,748 B2 * 10/2014 Posa H04H 20/48
 381/3
 8,867,758 B2 * 10/2014 Terlizzi H01R 13/2428
 379/428.01
 8,873,250 B2 * 10/2014 Kroupa B65H 75/4434
 242/400
 8,891,800 B1 * 11/2014 Shaffer H04R 1/1025
 381/384
 D719,548 S * 12/2014 Thompson D14/223
 8,983,108 B2 * 3/2015 Ho H04R 1/1016
 181/135
 D726,165 S * 4/2015 Kawaji D14/223
 9,002,049 B2 * 4/2015 Higgins H04R 25/602
 181/129
 D729,775 S * 5/2015 Seo D14/205
 D737,251 S * 8/2015 Thompson D14/223
 9,148,717 B2 * 9/2015 Shaffer H04R 1/1025
 D740,786 S * 10/2015 Huang D14/205
 D745,489 S * 12/2015 Bjelle D14/205
 D746,792 S * 1/2016 Kim D14/205
 D751,053 S * 3/2016 Shin D14/205
 D764,445 S * 8/2016 Czaniecki D14/223
 D767,532 S * 9/2016 Jen D14/205
 D772,840 S * 11/2016 Forslund D14/205
 D773,439 S * 12/2016 Walker D14/205
 9,532,128 B2 * 12/2016 Linden H04R 1/1025
 D776,634 S * 1/2017 Lee D14/205
 D777,710 S * 1/2017 Palmborg D14/223
 D781,269 S * 3/2017 Choe D14/223
 D782,442 S * 3/2017 Chen D14/205
 D782,998 S * 4/2017 Shin D14/205
 D788,079 S * 5/2017 Son D14/223
 D789,909 S * 6/2017 Hung D14/223
 D794,614 S * 8/2017 Xu D14/223
 D795,224 S * 8/2017 Valenzuela D14/223
 D795,225 S * 8/2017 Sumii D14/223
 D812,042 S * 3/2018 Xiao D14/223
 2007/0098201 A1 * 5/2007 Chen H04R 1/1016
 381/380
 2009/0304220 A1 * 12/2009 Fujikura H04R 1/1091
 381/380
 2010/0202626 A1 * 8/2010 Shiori H04R 1/1091
 381/74
 2012/0087532 A1 * 4/2012 Yang H04R 1/10
 381/380
 2014/0166122 A1 * 6/2014 Goldstein H04R 1/1041
 137/223
 2015/0245127 A1 * 8/2015 Shaffer H04R 1/1025
 381/380
 2015/0350762 A1 * 12/2015 Birger H04R 1/1016
 381/74

* cited by examiner

Fig. 1

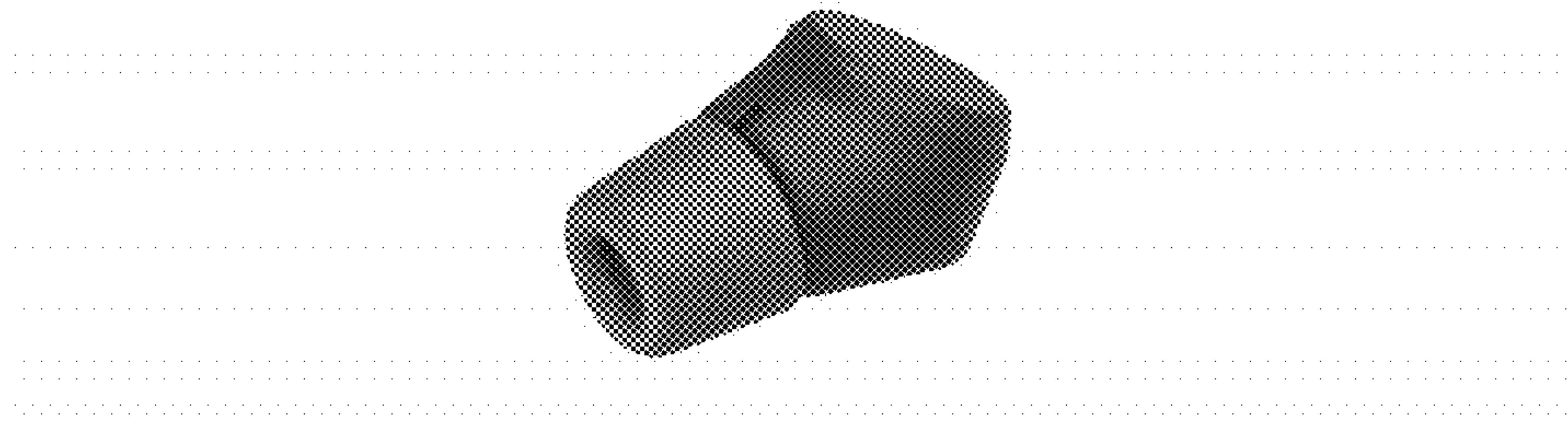

Fig. 2

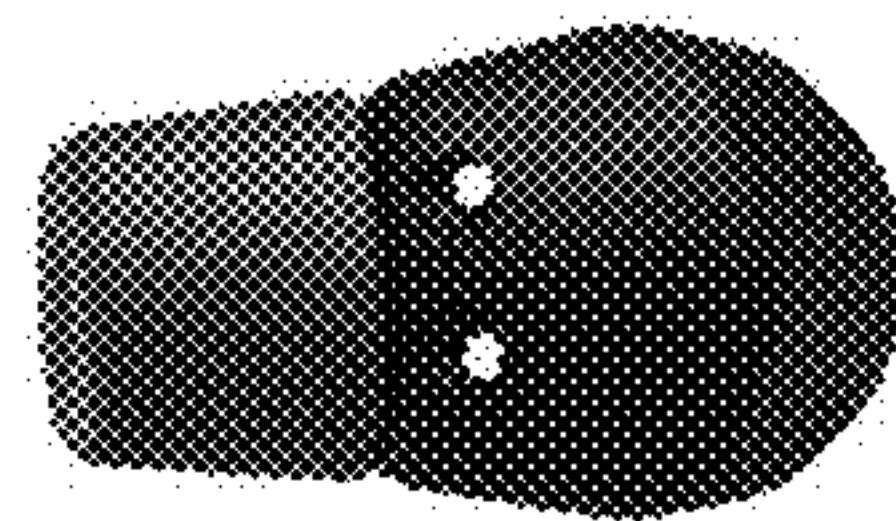

Fig. 3

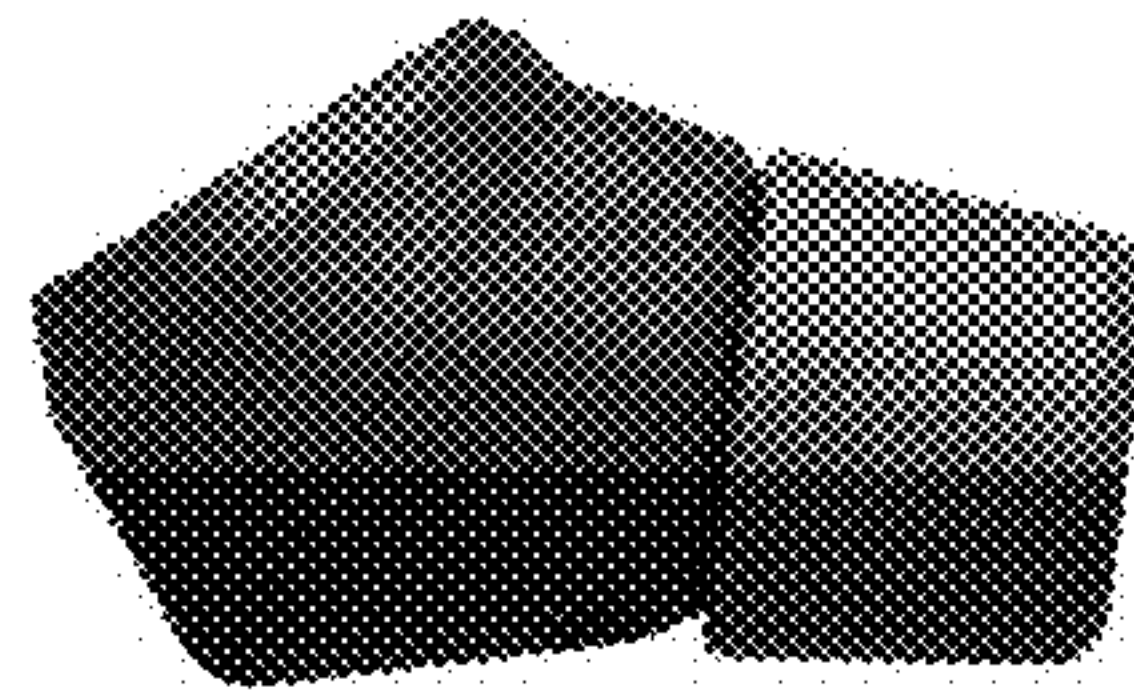

Fig. 4

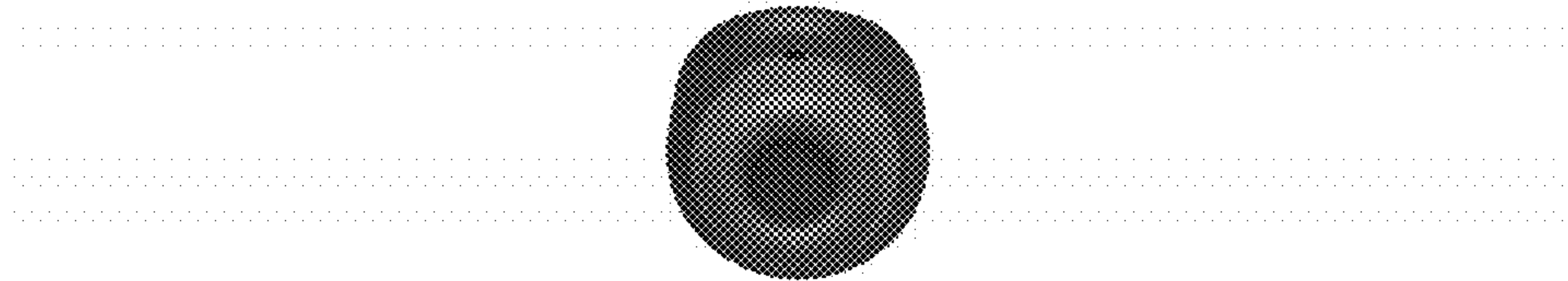

Fig. 5

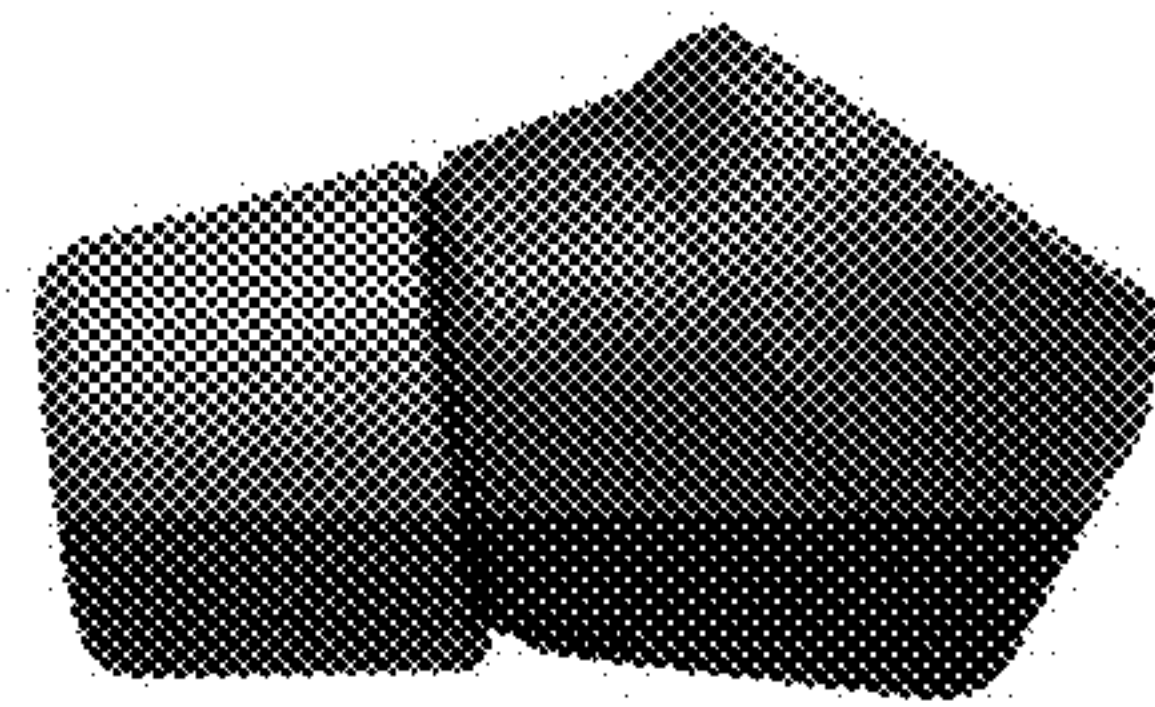

Fig. 6

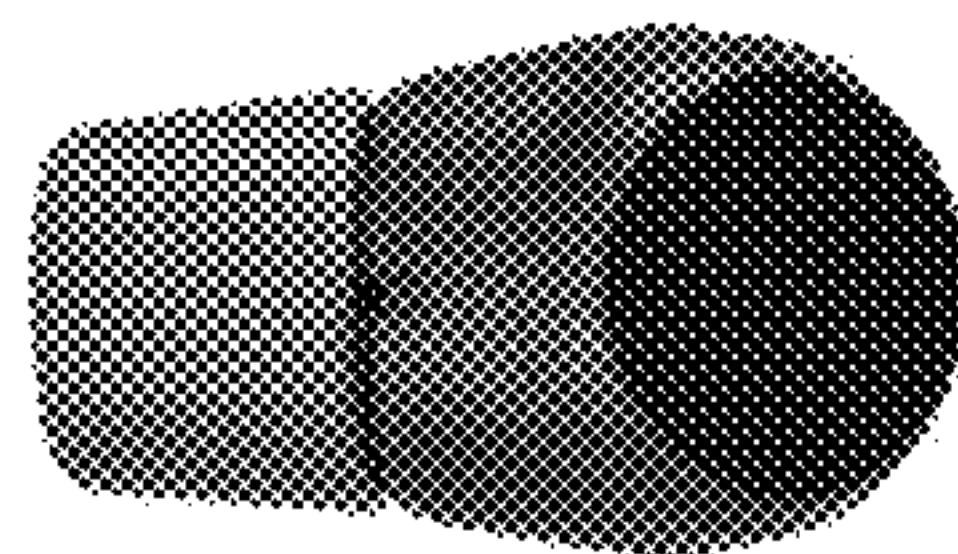

Fig. 7

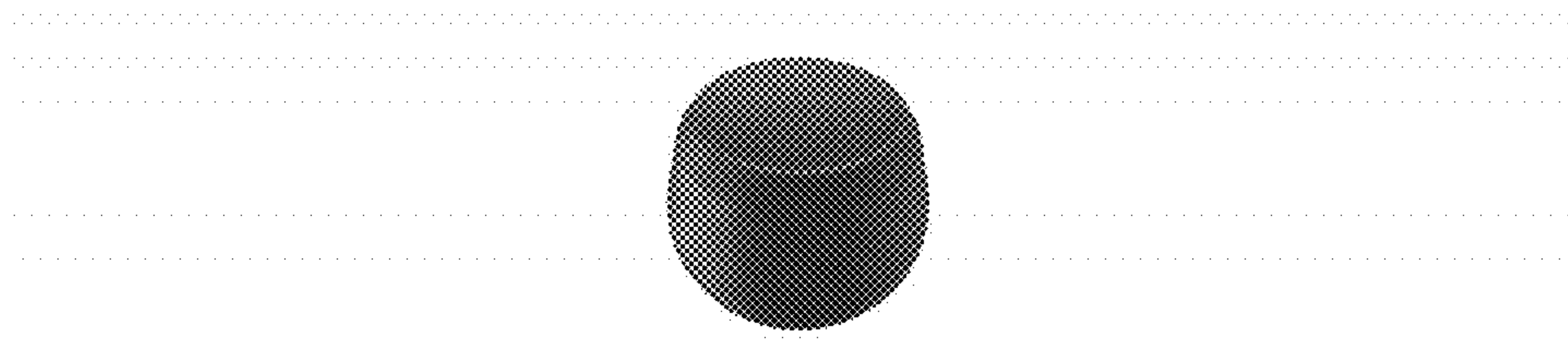

Fig. 8

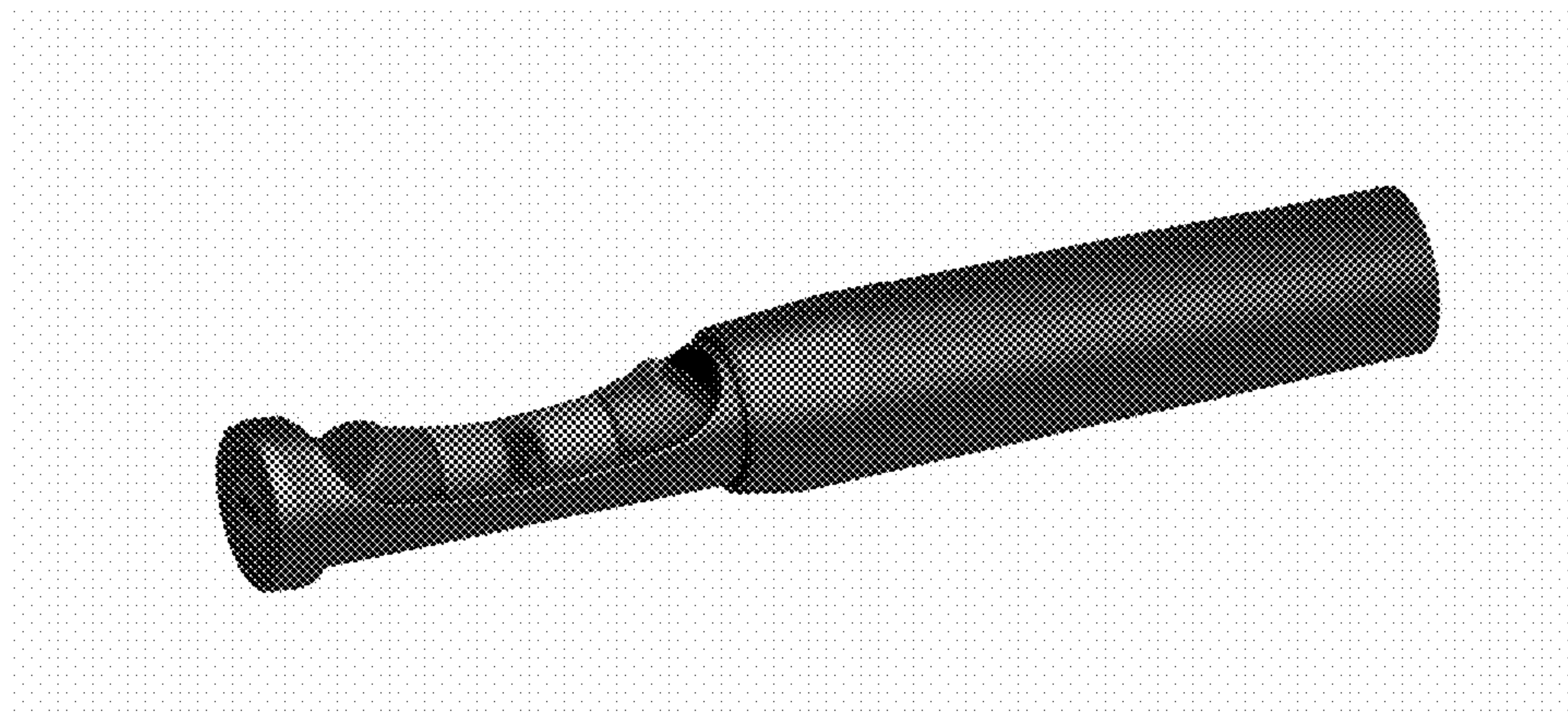

Fig. 9

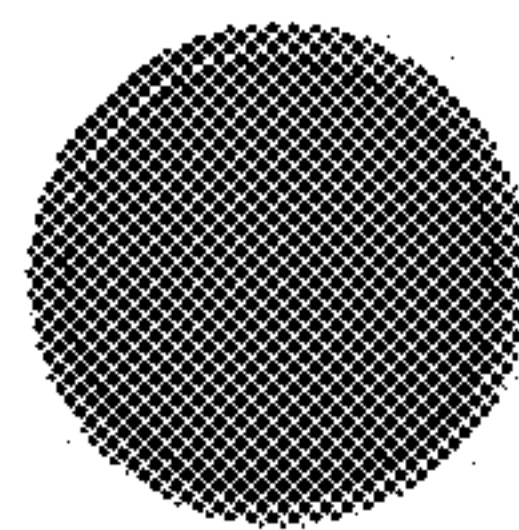

Fig. 10

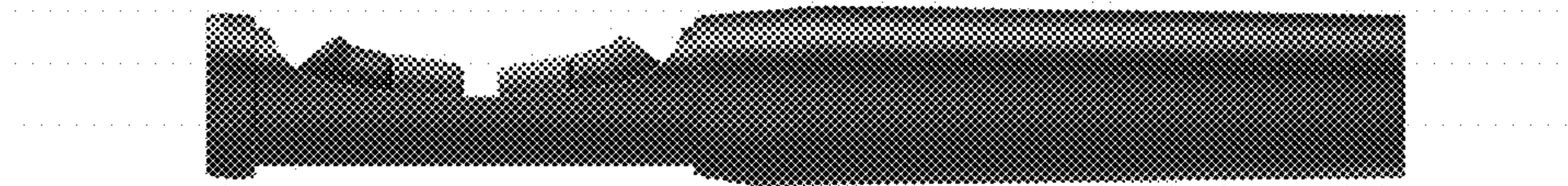

Fig. 11

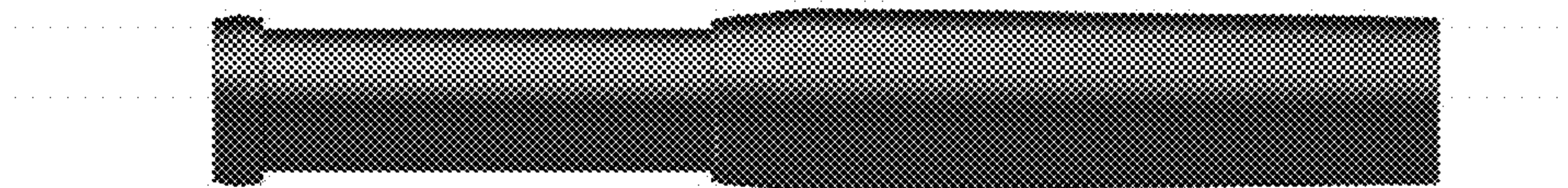

Fig. 12

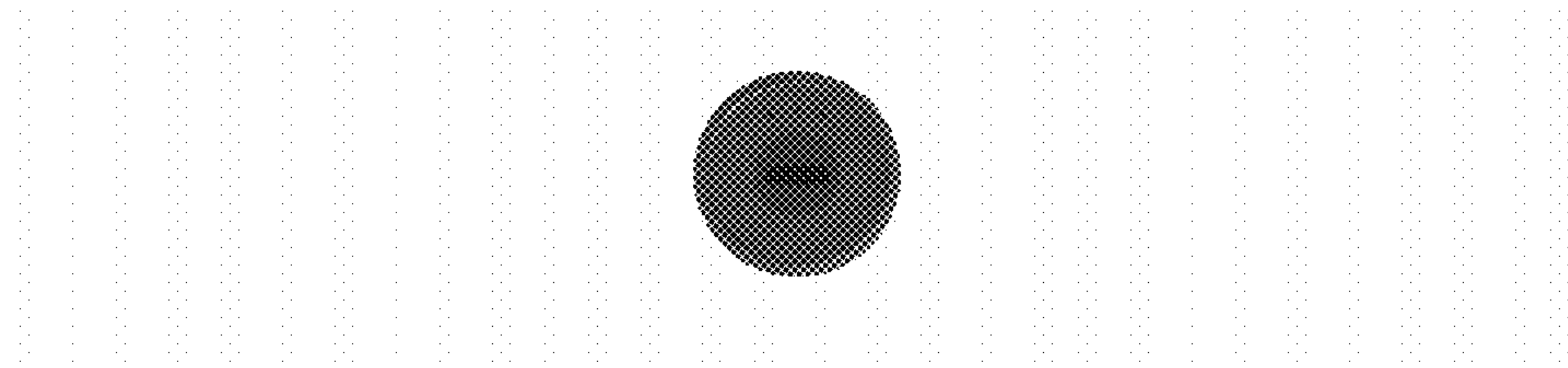

Fig. 13

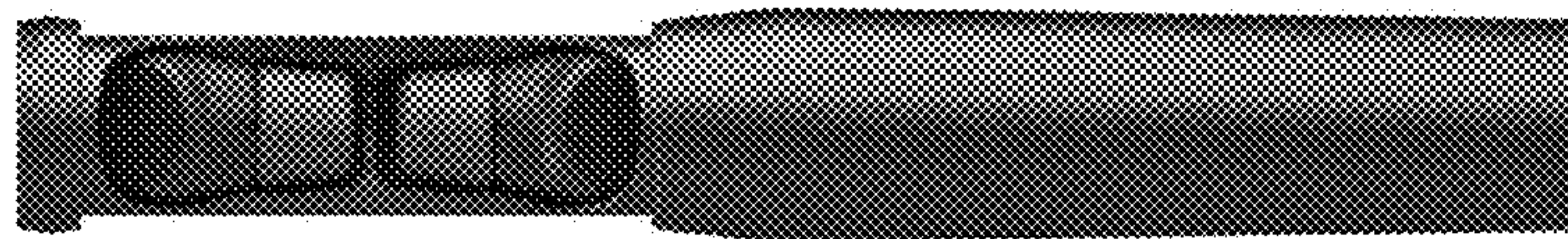

Fig. 14

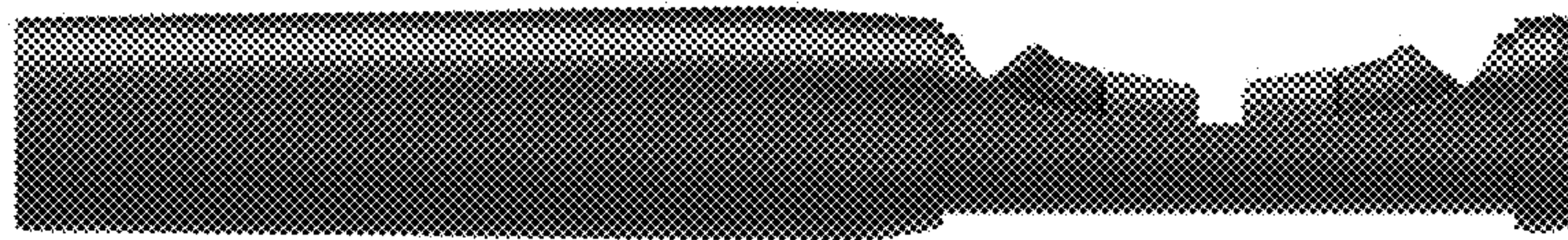

Fig. 15

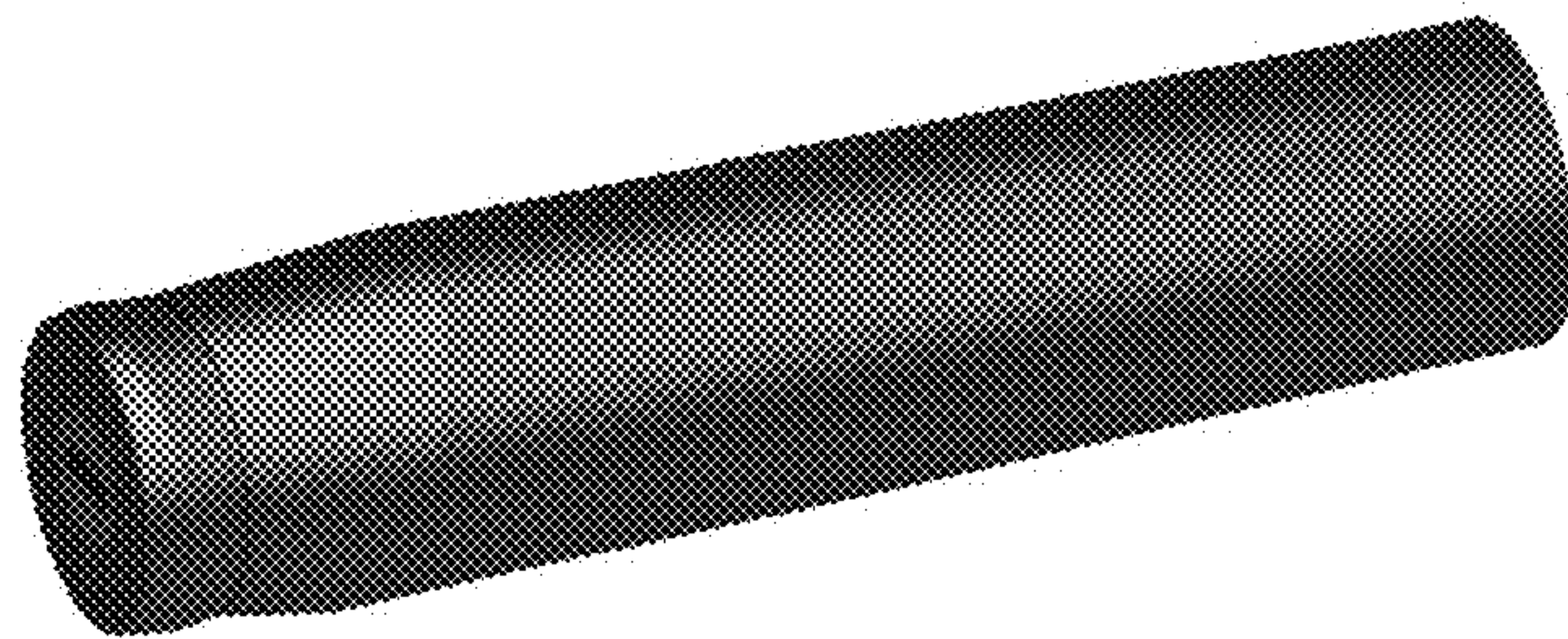

Fig. 16

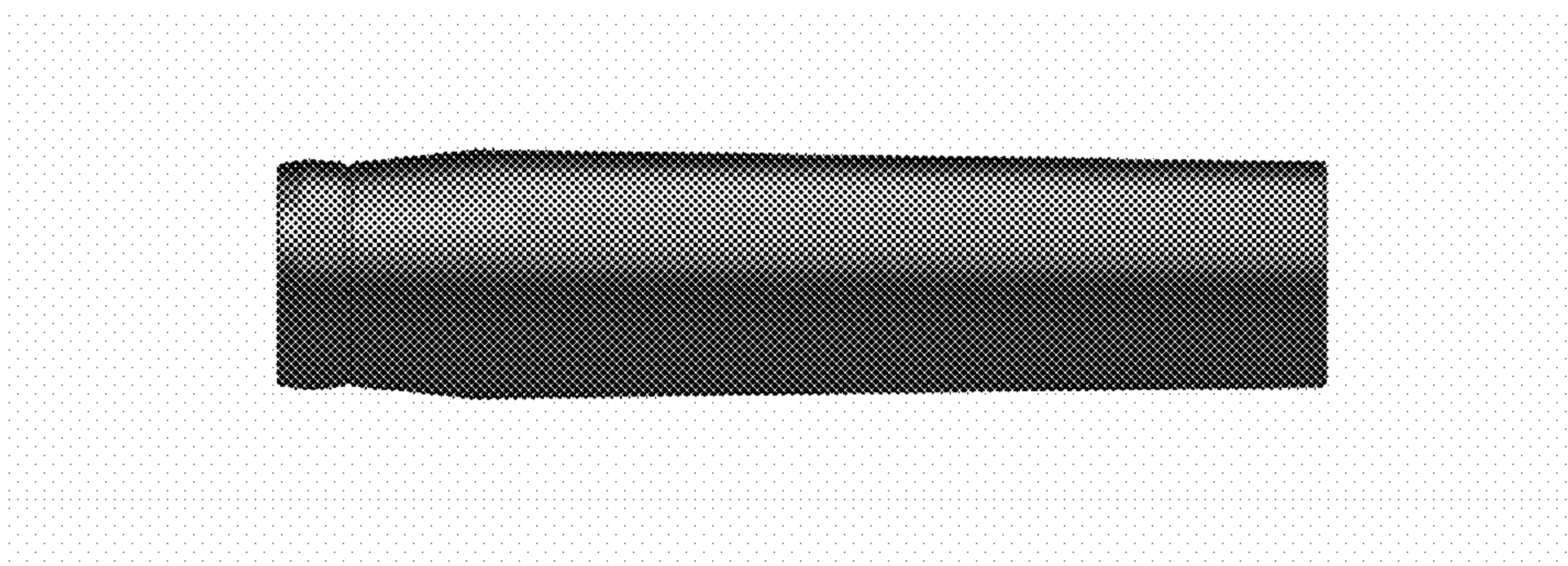

Fig. 17

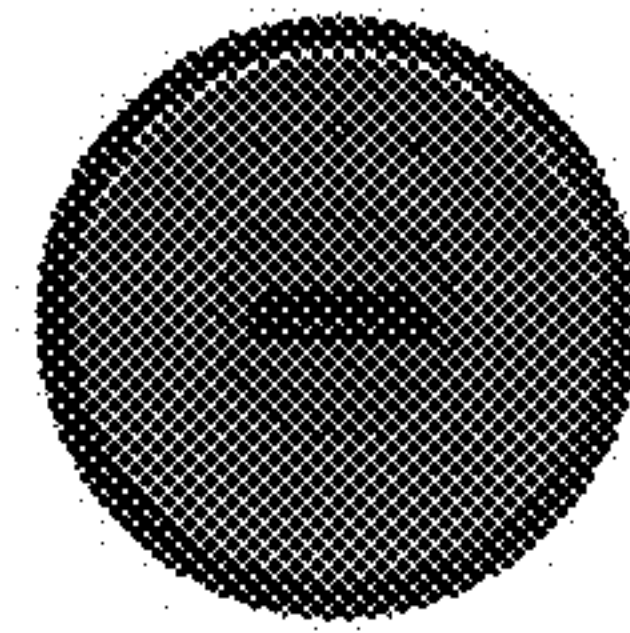

Fig. 18

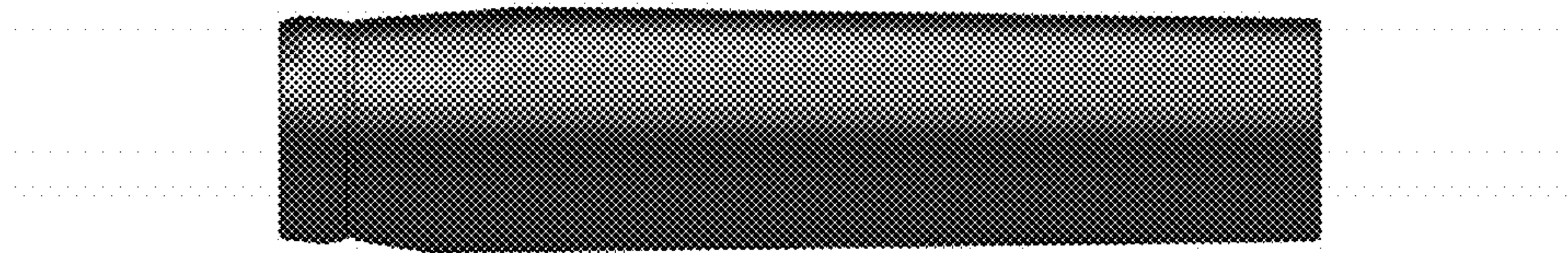

Fig. 19

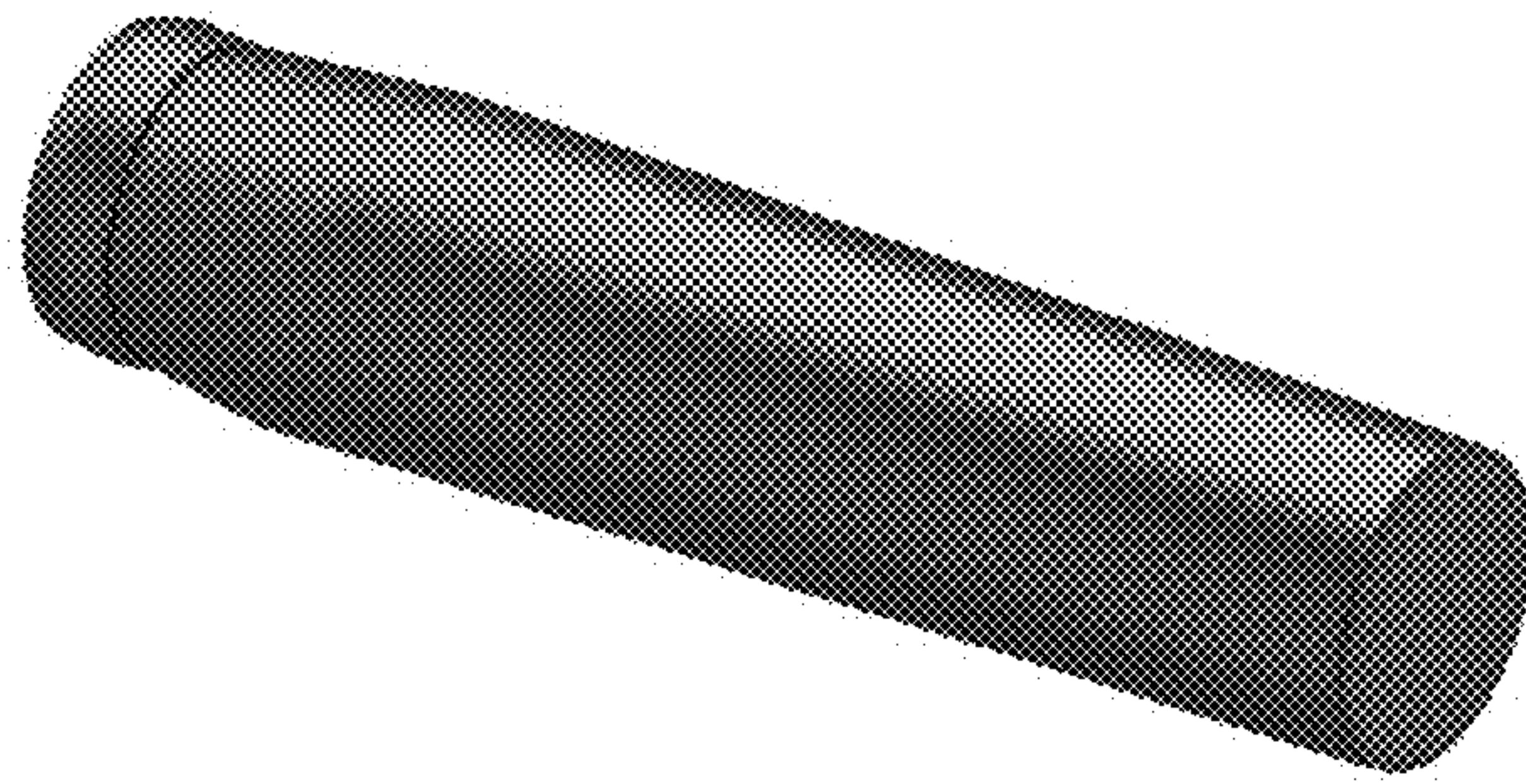

Fig. 20

