



US00D853251S

(12) **United States Design Patent**
Monachon

(10) **Patent No.:** **US D853,251 S**

(45) **Date of Patent:** **** Jul. 9, 2019**

(54) **WATCHCASE**

(71) Applicant: **OMEGA LTD.**, Biel/Bienne (CH)

(72) Inventor: **Jean-Claude Monachon**, Bevaix (CH)

(73) Assignee: **OMEGA LTD.**, Biel/Bienne (CH)

(**) Term: **15 Years**

(21) Appl. No.: **29/617,647**

(22) Filed: **Sep. 15, 2017**

(30) **Foreign Application Priority Data**

Mar. 15, 2017 (WO) DM/095 365

(51) **LOC (11) Cl.** **10-02**

(52) **U.S. Cl.**
USPC **D10/38**

(58) **Field of Classification Search**
USPC D10/1-2, 6, 10, 30-39, 40-41, 102-103,
D10/122-129, 132; D11/3; D14/344,
D14/440

CPC G04B 37/00; G04B 37/005; G04B 37/22;
G04B 17/00; G04B 19/223; G04B 19/24;
G04B 45/00; G04B 45/0061; G04B
45/0069; G04B 45/0084; G04B 45/0076;
A45C 11/10; A45C 11/12; A45C 13/008

See application file for complete search history.

(56) **References Cited**

U.S. PATENT DOCUMENTS

D409,097 S * 5/1999 Monachon D10/32
D590,274 S * 4/2009 Monachon D10/128
D703,553 S * 4/2014 Monachon D10/32
D727,751 S * 4/2015 Lee D10/35
D732,986 S * 6/2015 Monachon D10/31
D793,898 S * 8/2017 Monachon D11/82
D795,730 S * 8/2017 Monachon D10/132
D801,195 S * 10/2017 Monachon D10/30
D817,298 S * 5/2018 Adachi D14/158

D818,376 S * 5/2018 Monachon D10/38
D820,116 S * 6/2018 Monachon D10/38
D822,509 S * 7/2018 Monachon D10/38

(Continued)

OTHER PUBLICATIONS

Omega Railmaster Baselworld 2017 | posted at monochrome-watches.com Mar. 30, 2017 [online]. © 2006-2019 Monochrome [retrieved Feb. 26, 2019] from Internet: <https://monochrome-watches.com/omega-railmaster-master-chronometer-collection-baselworld-2017-price/> (Year: 2017).*

(Continued)

Primary Examiner — Sandra S Snapp

Assistant Examiner — Katherine Glennon

(74) *Attorney, Agent, or Firm* — Abelman, Frayne & Schwab

(57) **CLAIM**

The ornamental design for a watchcase, as shown and described.

DESCRIPTION

FIG. 1 is a front right perspective view of a watchcase showing my new design;
FIG. 2 is a rear left perspective view thereof;
FIG. 3 is a front view thereof;
FIG. 4 is a rear view thereof;
FIG. 5 is a left side view thereof;
FIG. 6 is a right side view thereof;
FIG. 7 is a bottom view thereof; and,
FIG. 8 is a top view thereof.

The portions of the watchcase shown in broken lines form no part of the claimed design. The word "RAILMASTER" that appears on the back of the watch, and the Greek letter "Omega" that appears on the back of the watch and the watch crown, are both registered trademarks of the Applicant, OMEGA SA (OMEGA AG) (OMEGA LTD.).

1 Claim, 6 Drawing Sheets

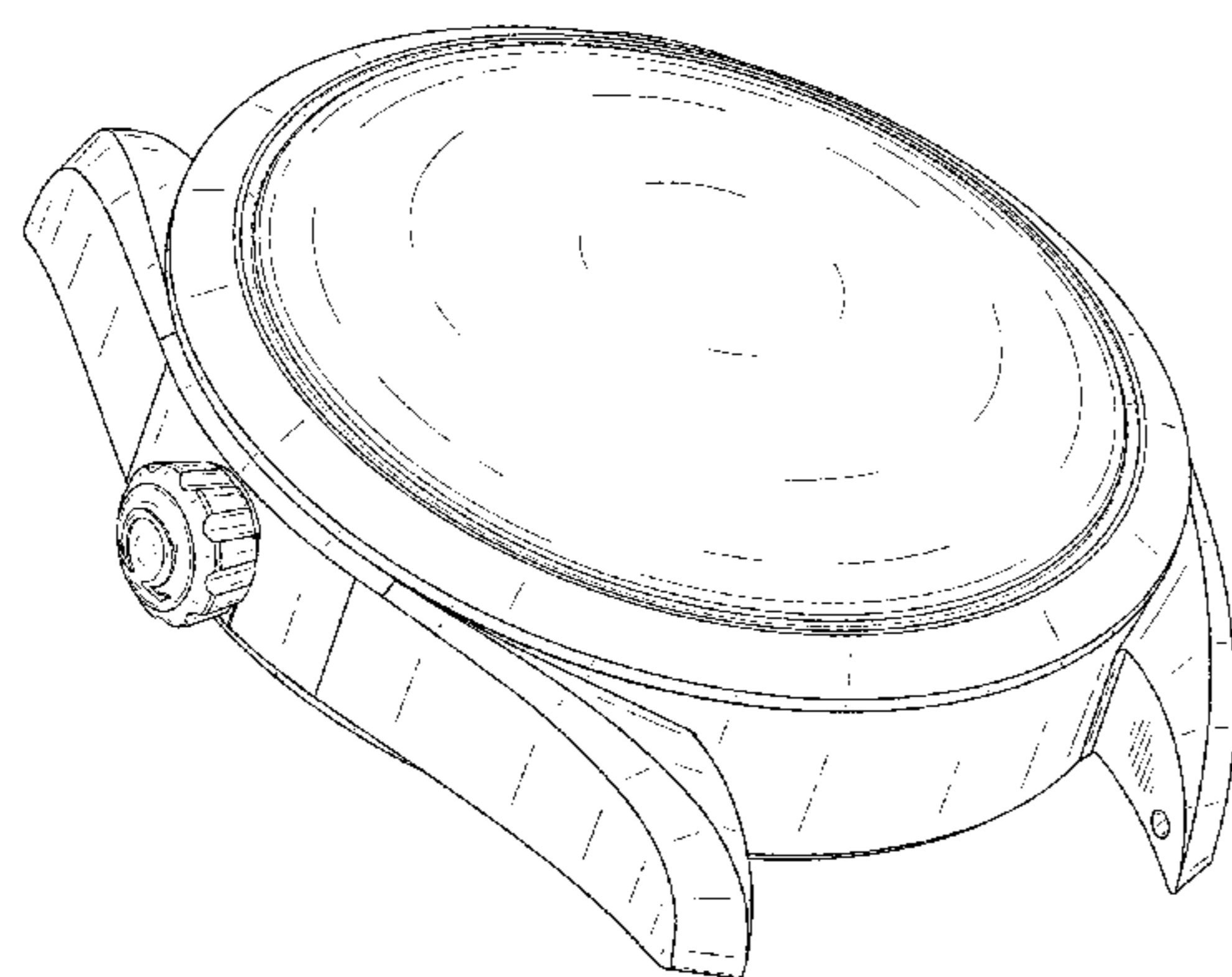

(56)

References Cited

U.S. PATENT DOCUMENTS

D823,137 S * 7/2018 Monachon D10/38
D824,794 S * 8/2018 Monachon D10/128
D834,953 S * 12/2018 Agayev D10/30

OTHER PUBLICATIONS

Omega Seamaster Aqua Terra Railmaster | posted at wornandwound.com Jul. 2017 [online]. © 2011-2017, worn&wound LLC [retrieved Feb. 26, 2019] from Internet: <<https://wornandwound.com/review/omega-seamaster-aqua-terra-railmaster-review/>> (Year: 2017).*

* cited by examiner

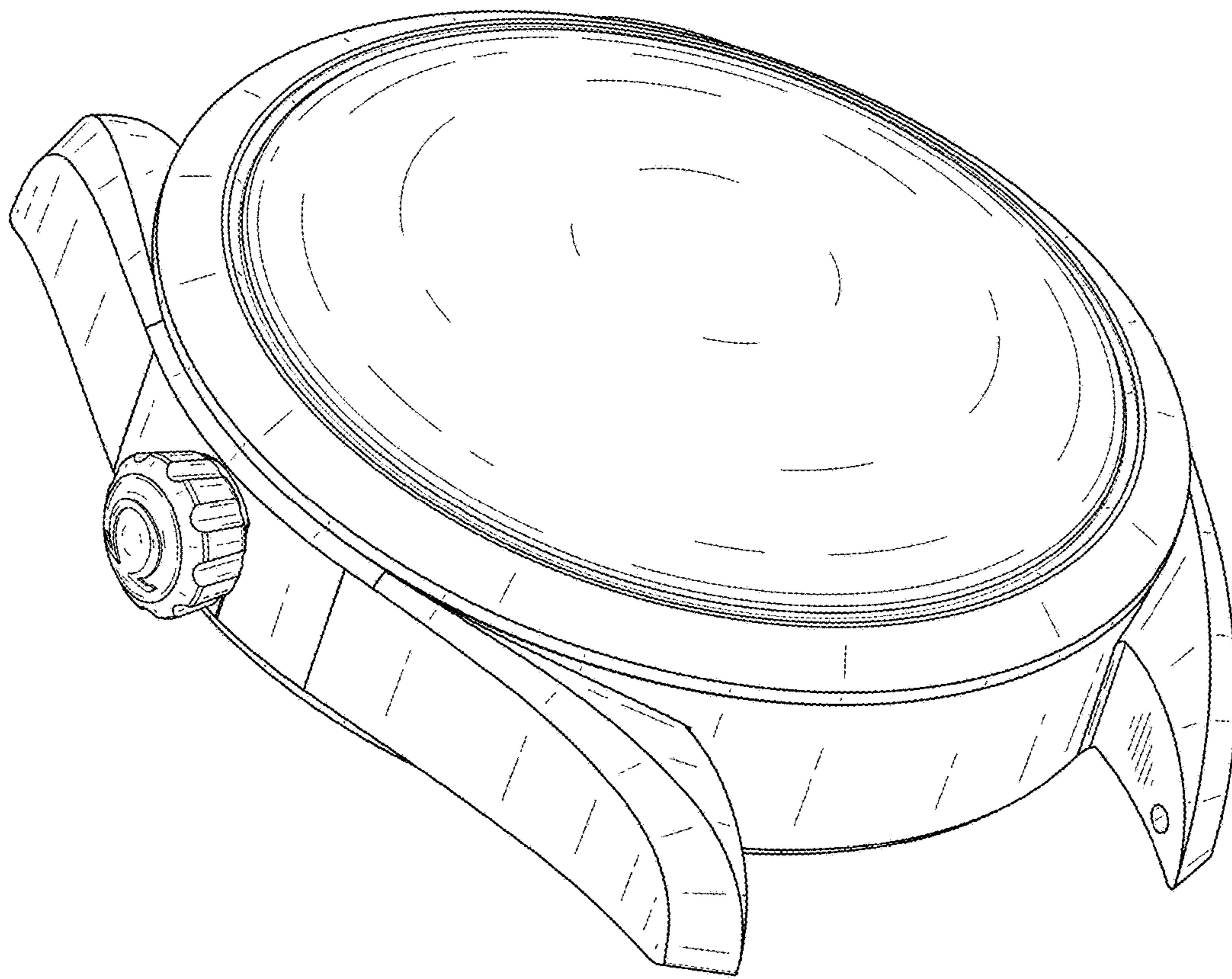

FIG. 1



FIG. 2

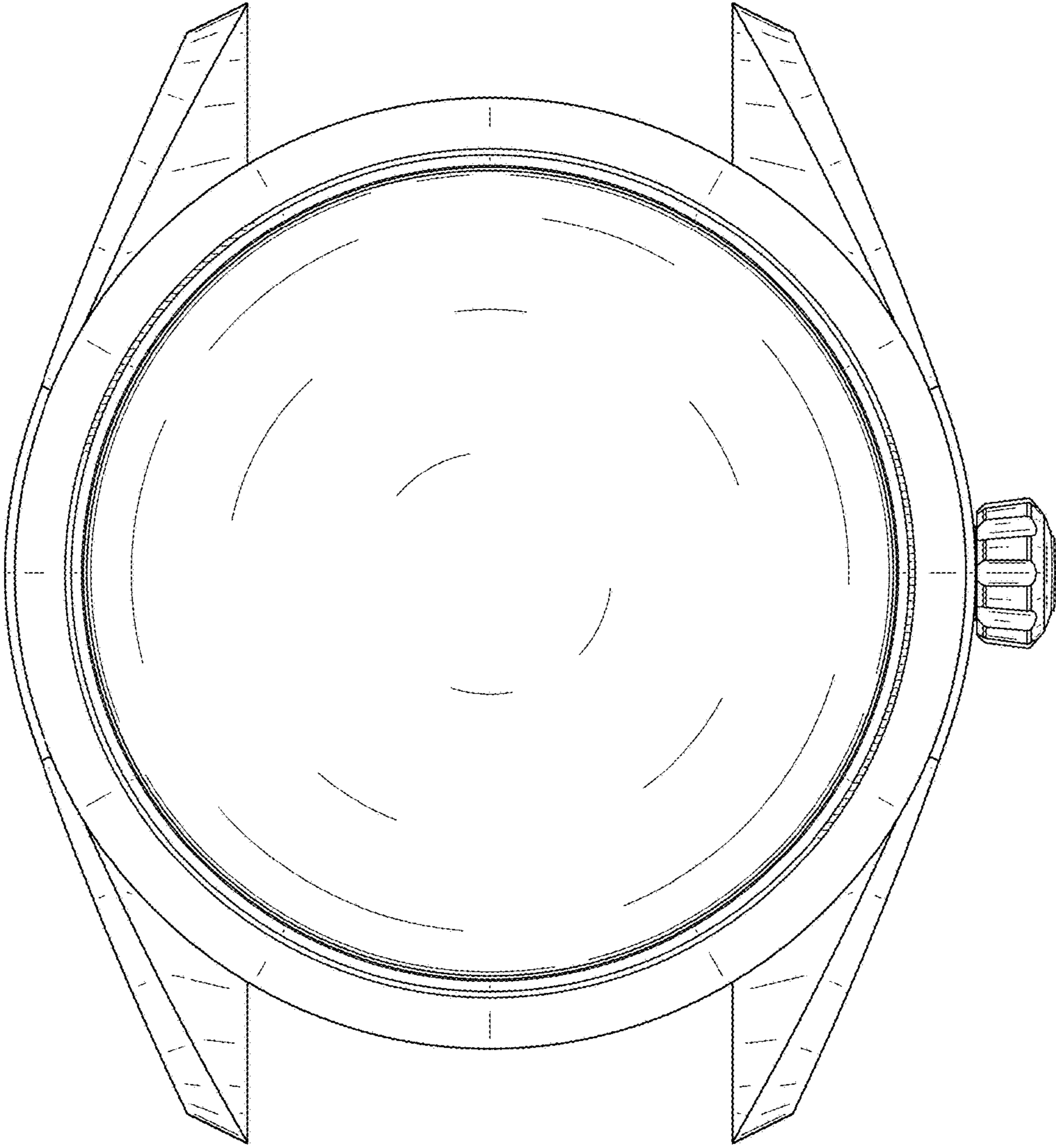

FIG. 3



FIG. 4

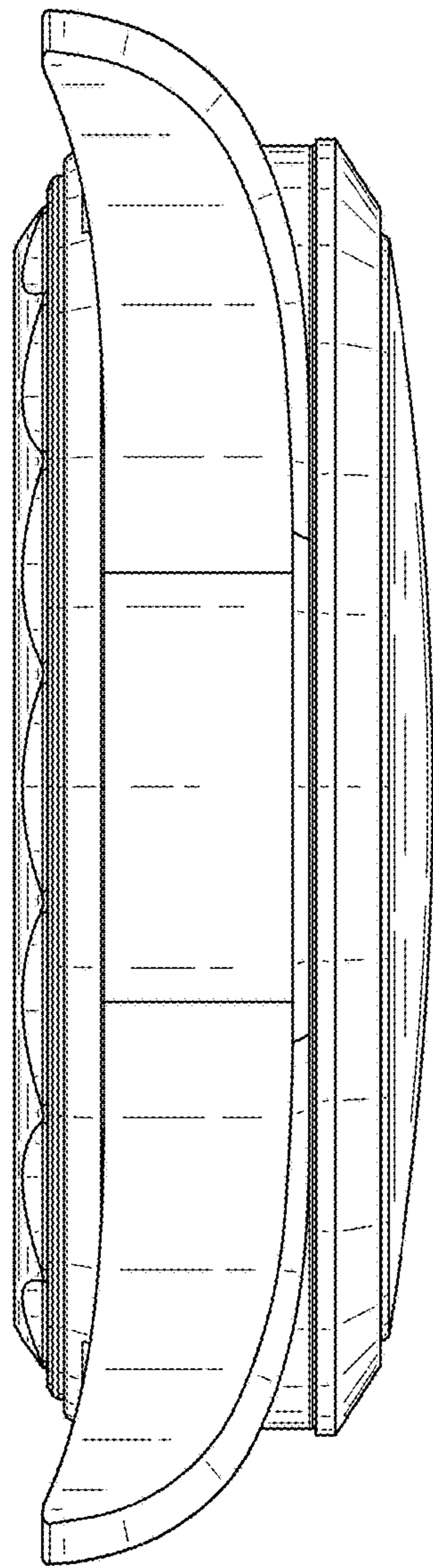

FIG. 5

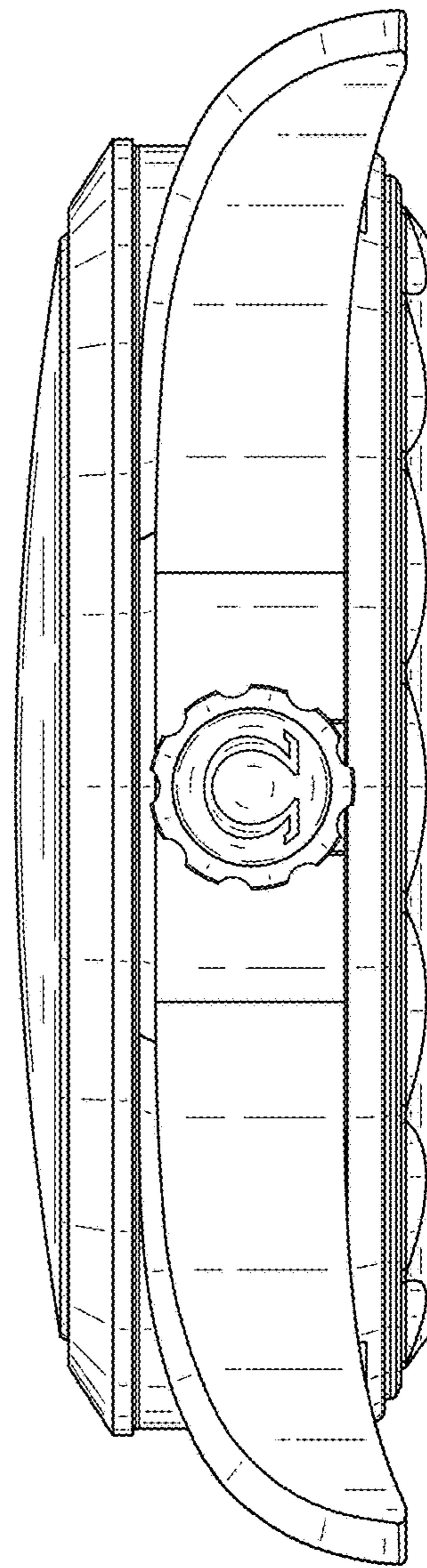

FIG. 6

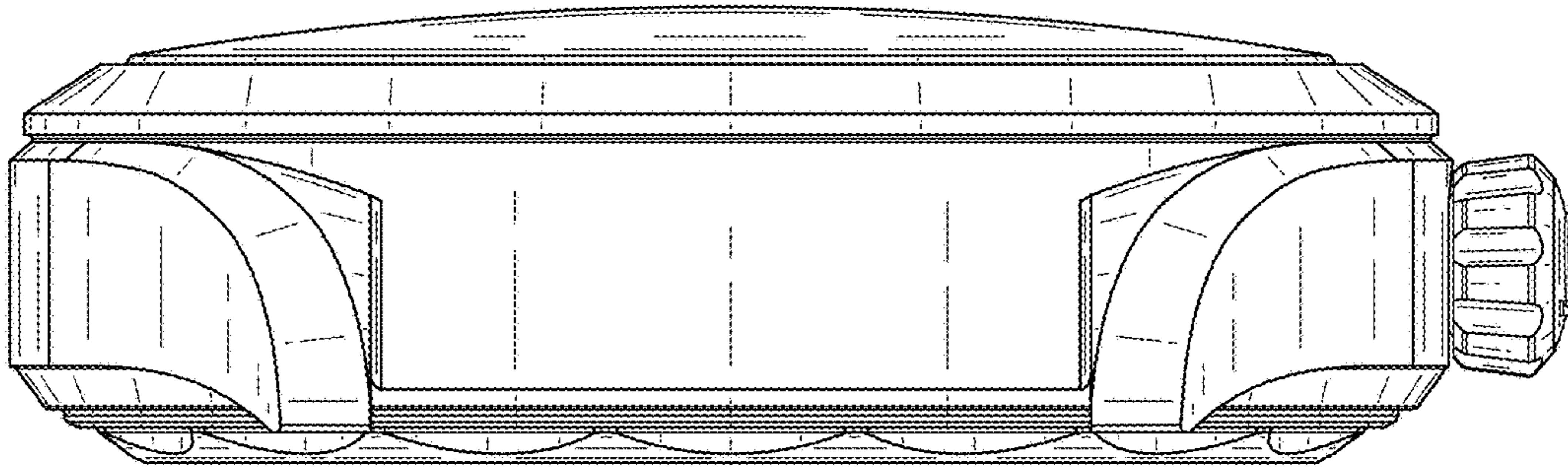

FIG. 7

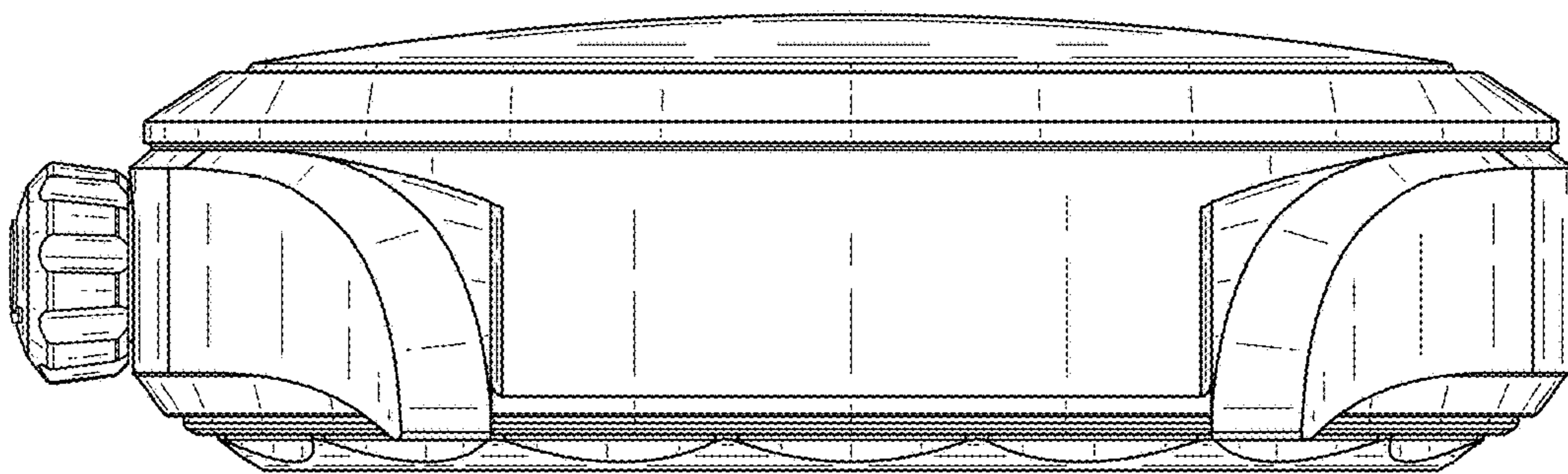

FIG. 8