



US00D853233S

(12) **United States Design Patent** (10) **Patent No.:** **US D853,233 S**
Hessburg (45) **Date of Patent:** **** Jul. 9, 2019**

- (54) **PACKAGING CONTAINER FOR BOTTLES**
- (71) Applicant: **Sip Better, Inc.**, Minneapolis, MN (US)
- (72) Inventor: **Anthony Todd Hessburg**, Minnetrista, MN (US)
- (73) Assignee: **Anthony Todd Hessburg**, Minnetrista, MN (US)

- D463,978 S * 10/2002 DiMartino D9/415
 - D471,358 S * 3/2003 Yang D3/276
 - D523,634 S * 6/2006 Dost D3/273
 - D607,320 S * 1/2010 Tearle D9/423
 - D668,948 S * 10/2012 LaTrobe D9/433
 - 8,523,048 B1 9/2013 Spiegelman
 - D710,693 S * 8/2014 Bhasin D9/434
 - D747,960 S * 1/2016 Sculler D9/418
 - D752,425 S * 3/2016 Parthenis, Jr. D9/414
- (Continued)

(**) Term: **15 Years**

(21) Appl. No.: **29/611,733**

(22) Filed: **Jul. 25, 2017**

(51) **LOC (11) Cl.** **09-03**

(52) **U.S. Cl.**
USPC **D9/432; D9/433**

(58) **Field of Classification Search**
USPC D9/414-434, 442-445, 456, 457, 542, D9/563, 600, 614-624, 661-664, 648, D9/655, 657, 658, 685, 696, 697-699, D9/707, 711, 754, 759, 772-776; D3/273, 276, 304, 309-313; D7/601, D7/602, 709

CPC B65D 5/00; B65D 5/001; B65D 5/0015; B65D 5/0227-0254; B65D 5/18; B65D 5/38; B65D 5/40; B65D 5/2033; B65D 1/22; B65D 1/24; B65D 1/34; B65B 5/06
See application file for complete search history.

(56) **References Cited**

U.S. PATENT DOCUMENTS

- D274,406 S * 6/1984 Hung D9/418
- D276,503 S * 11/1984 Mansau D9/455
- D311,331 S * 10/1990 Diba D9/415
- 5,116,290 A 5/1992 Ross
- D368,656 S * 4/1996 Campbell-Scott D9/430
- 5,730,289 A 3/1998 Cappels
- 5,967,320 A 10/1999 Cappels
- D462,874 S * 9/2002 Simcox D3/313

FOREIGN PATENT DOCUMENTS

- CH 360646 8/1958
- EP 2583906 10/2011

(Continued)

Primary Examiner — Susan Bennett Hattan
Assistant Examiner — Omeed Agilee
(74) *Attorney, Agent, or Firm* — Barnes & Thornburg LLP; Scott Rothenberger

(57) **CLAIM**

The ornamental design for a packaging container for bottles, as shown and described.

DESCRIPTION

FIG. 1 is a perspective view of the new design for a packaging container for bottles;
FIG. 2 is a front view thereof;
FIG. 3 is a rear view thereof;
FIG. 4 is a left side view thereof;
FIG. 5 is a right side view thereof;
FIG. 6 is a top plan view thereof;
FIG. 7 is a bottom plan view thereof; and,
FIG. 8 is an unfolded interior view of thereof.

The broken lines illustrate portions of the packaging container for bottles that form no part of the claimed design. The dot-dash-dot broken lines illustrate boundaries in the packaging container for bottles that form no part of the claimed design.

1 Claim, 6 Drawing Sheets

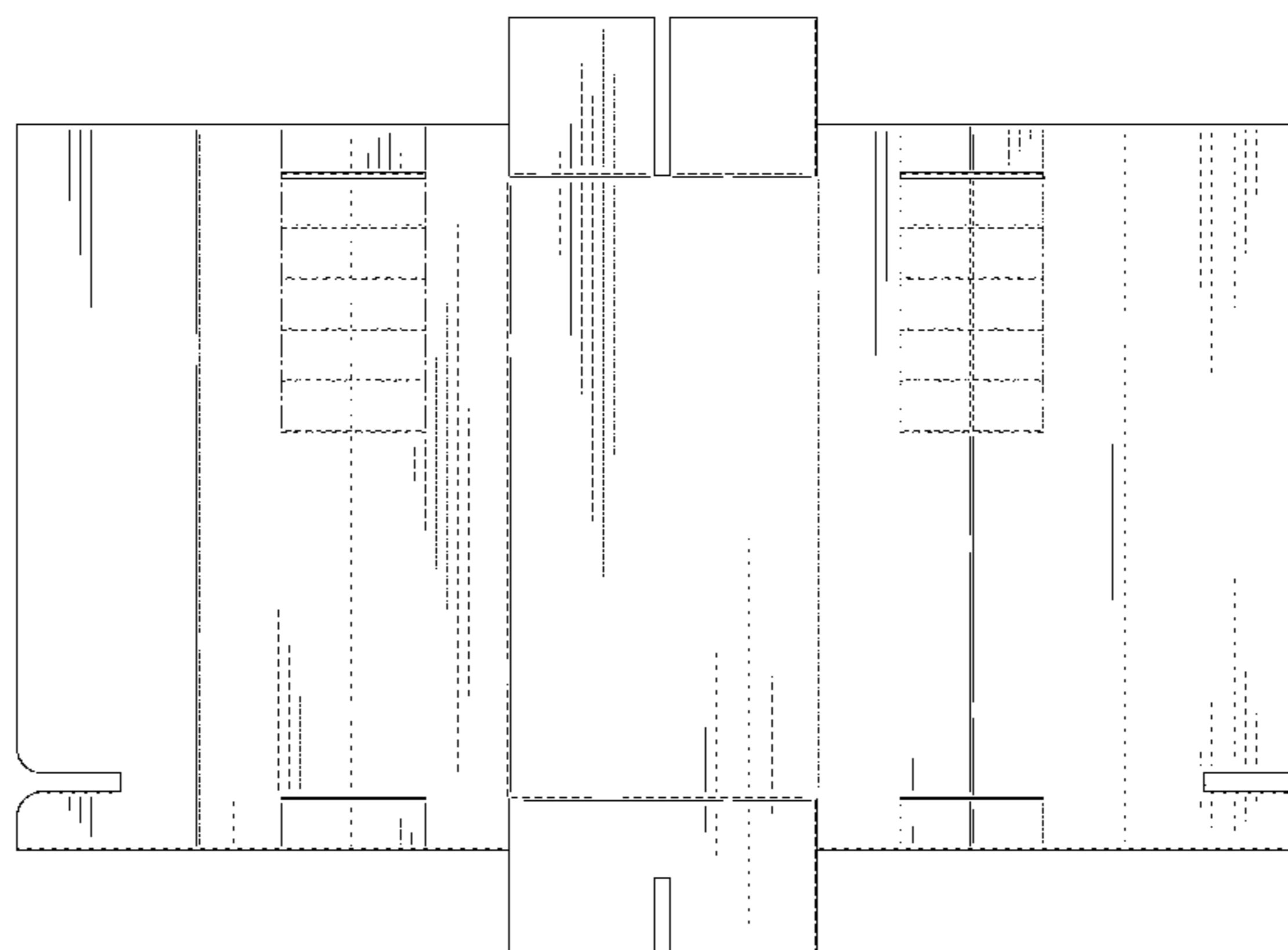
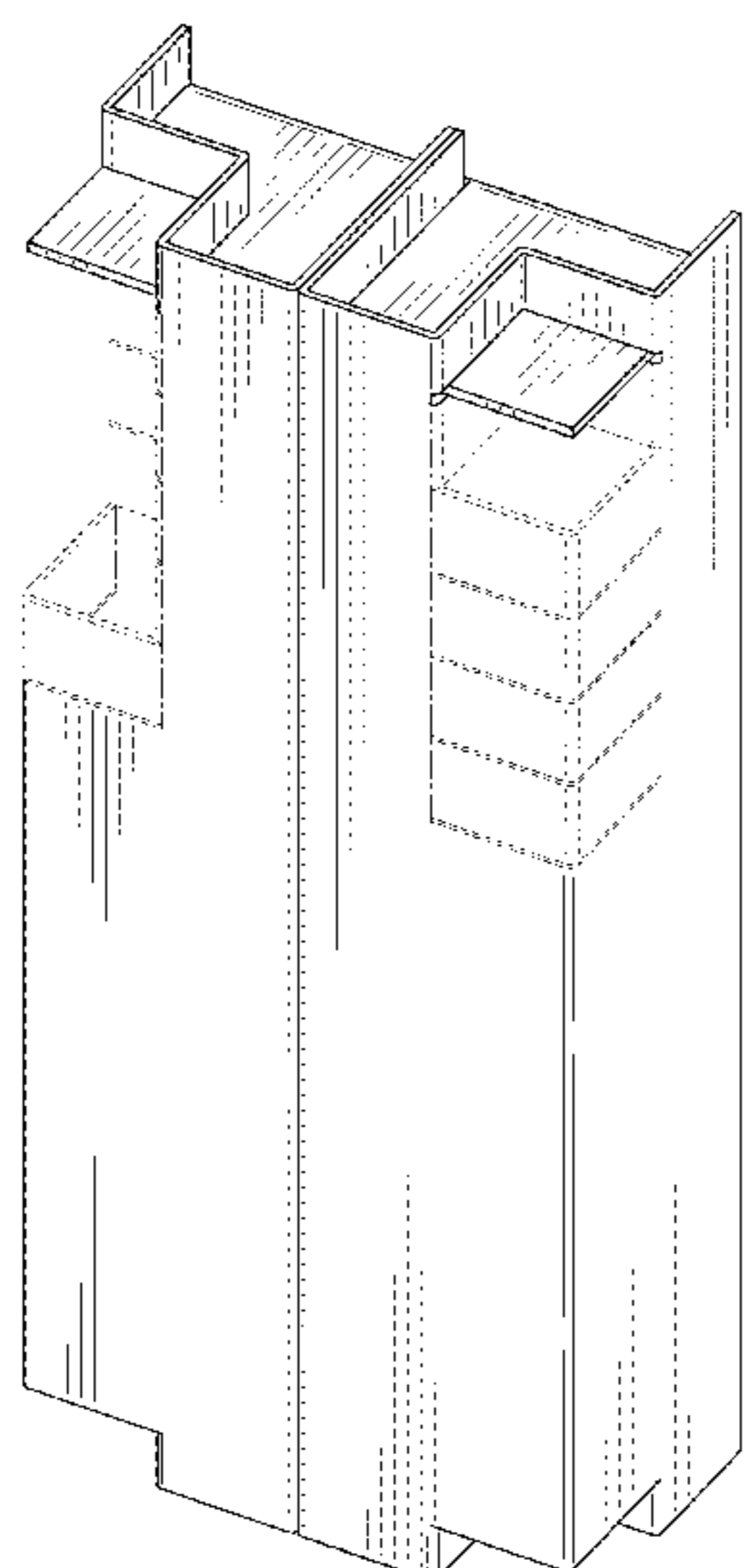

(56)

References Cited

U.S. PATENT DOCUMENTS

D756,562 S * 5/2016 Ghiotti D9/432
2017/0334596 A1* 11/2017 Cruz B65D 71/0096

FOREIGN PATENT DOCUMENTS

EP	2848546	9/2013
EP	2949588	5/2014
GB	965695	5/1961
GB	2344812	12/1998

* cited by examiner

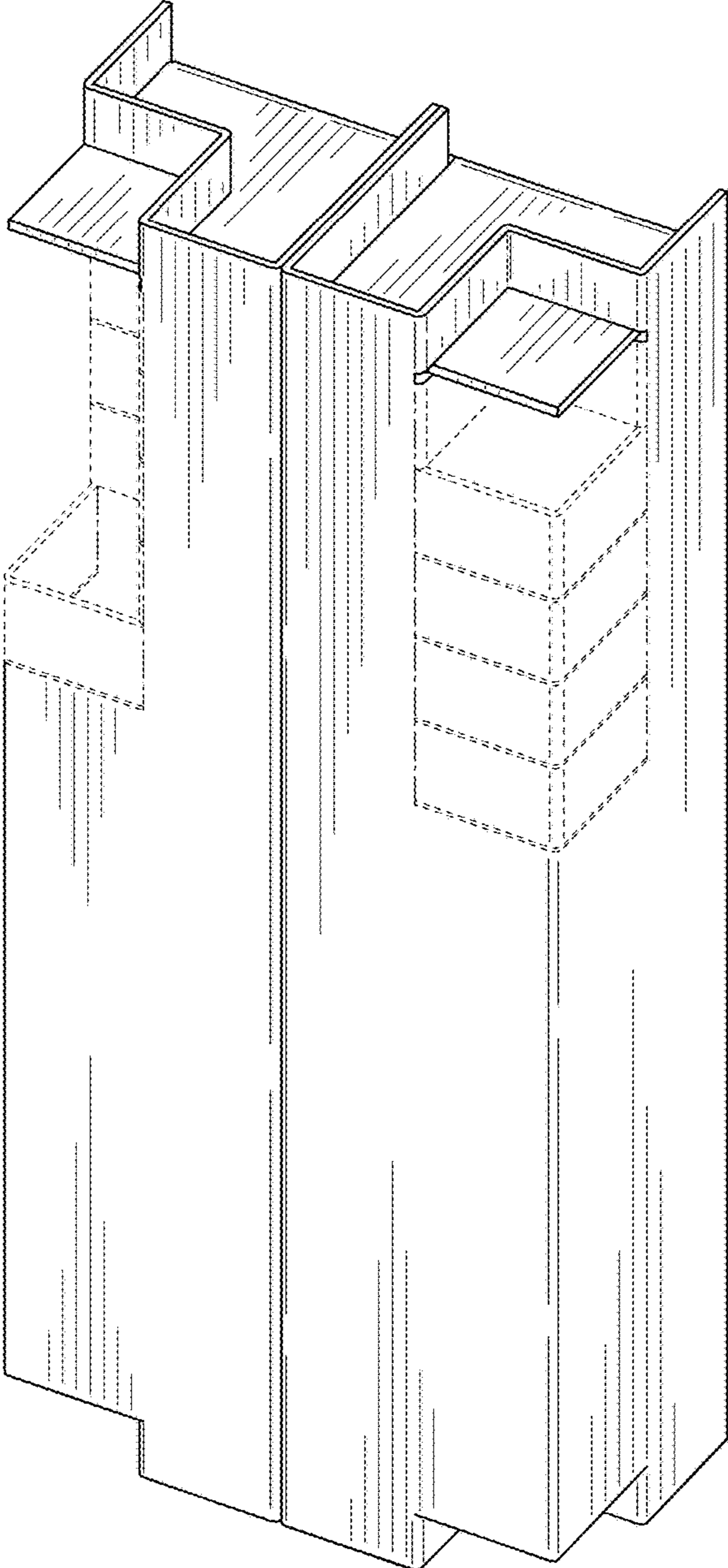

FIG. 1

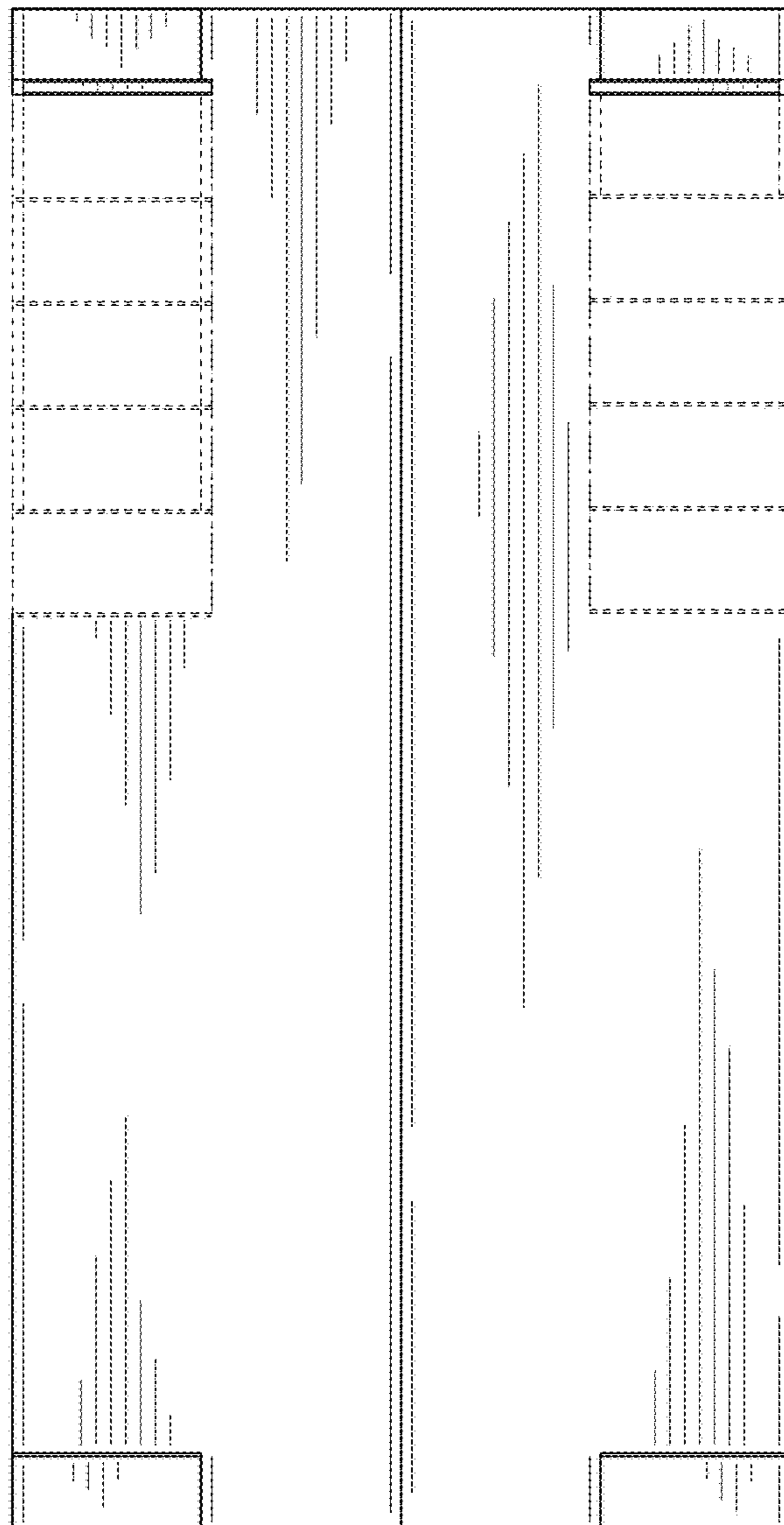

FIG. 2

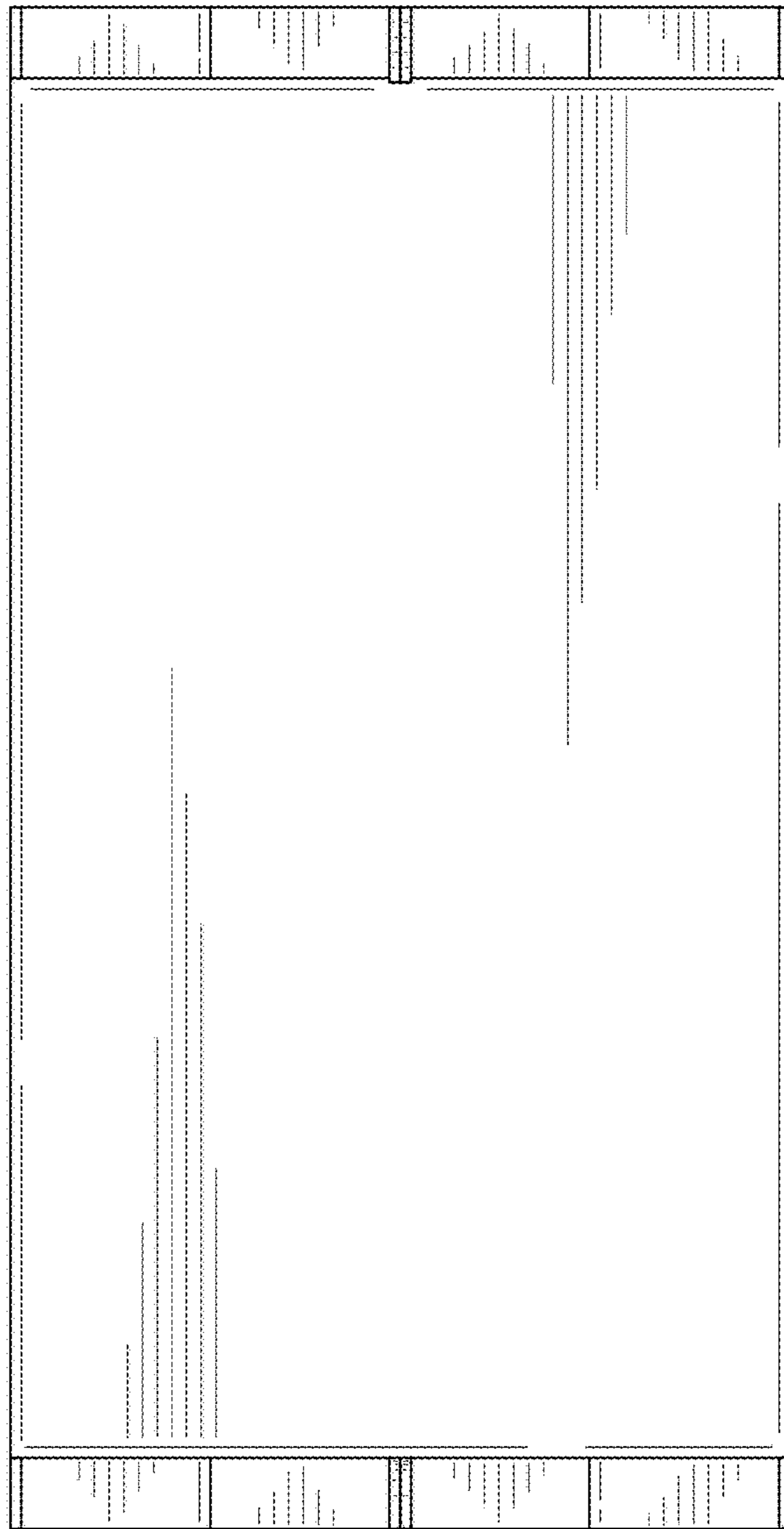

FIG. 3

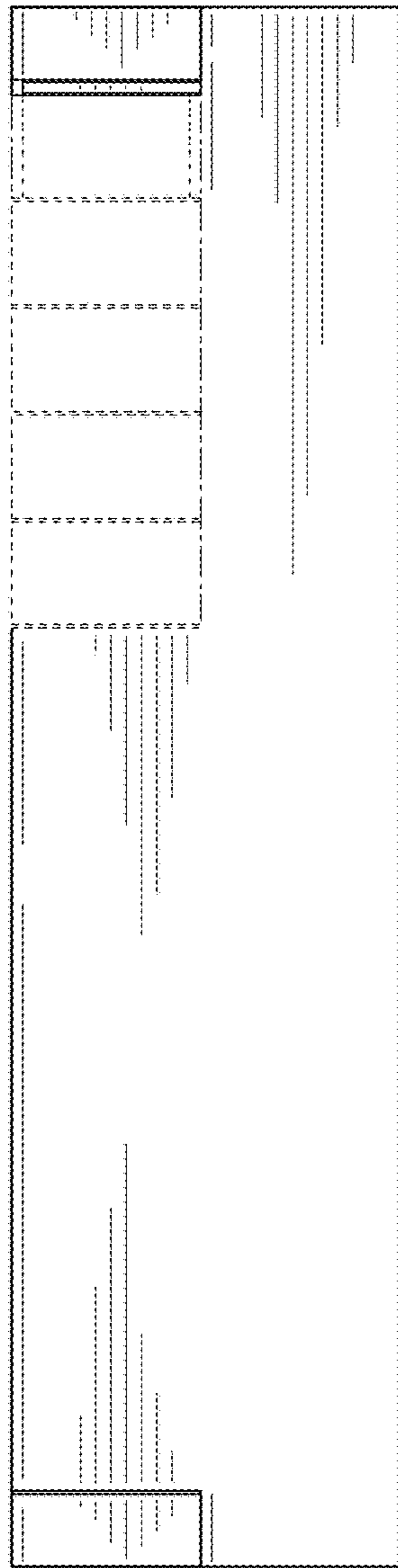

FIG. 4

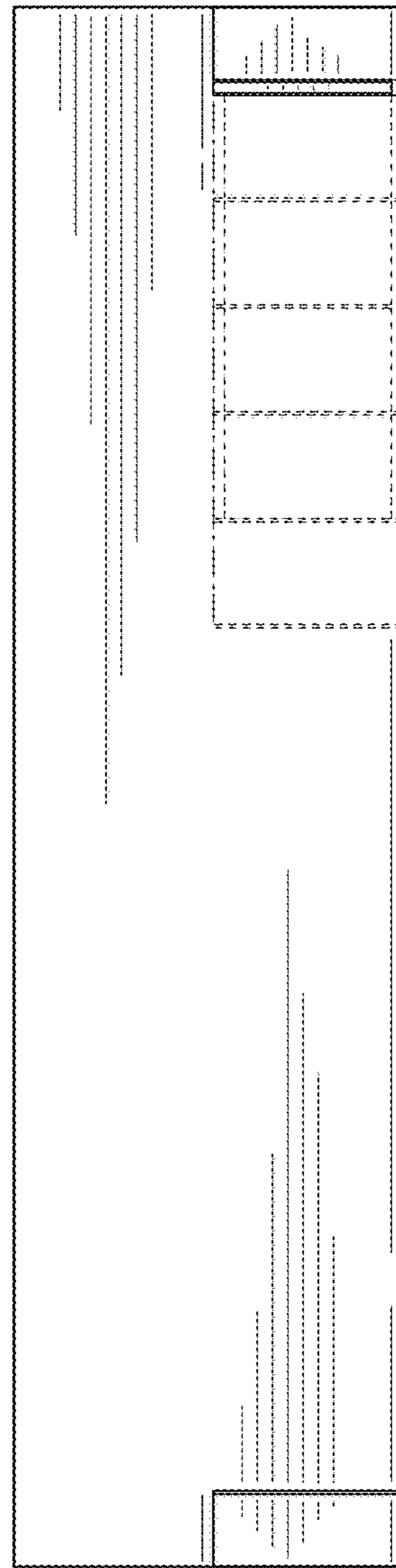

FIG. 5

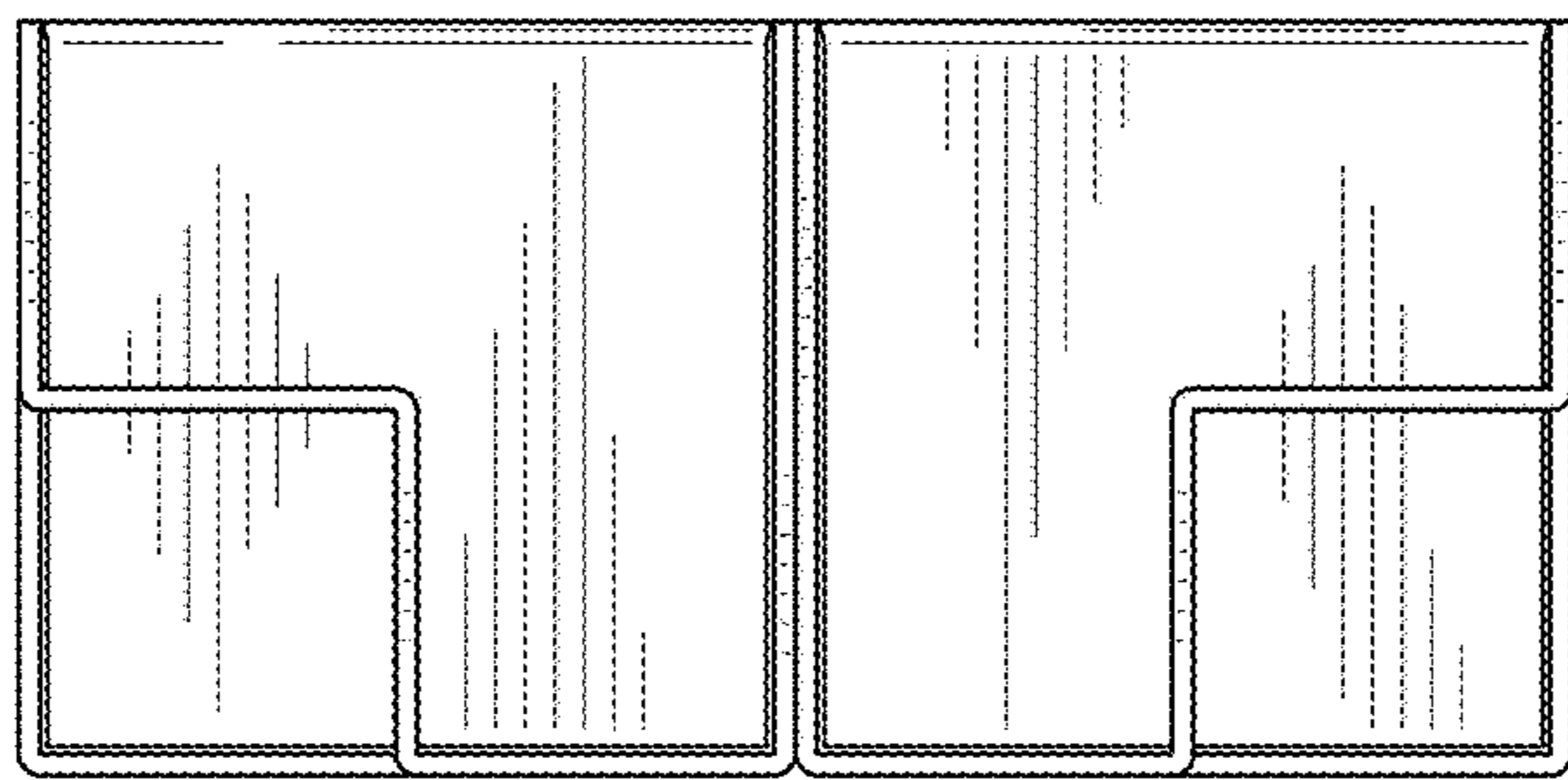

FIG. 6

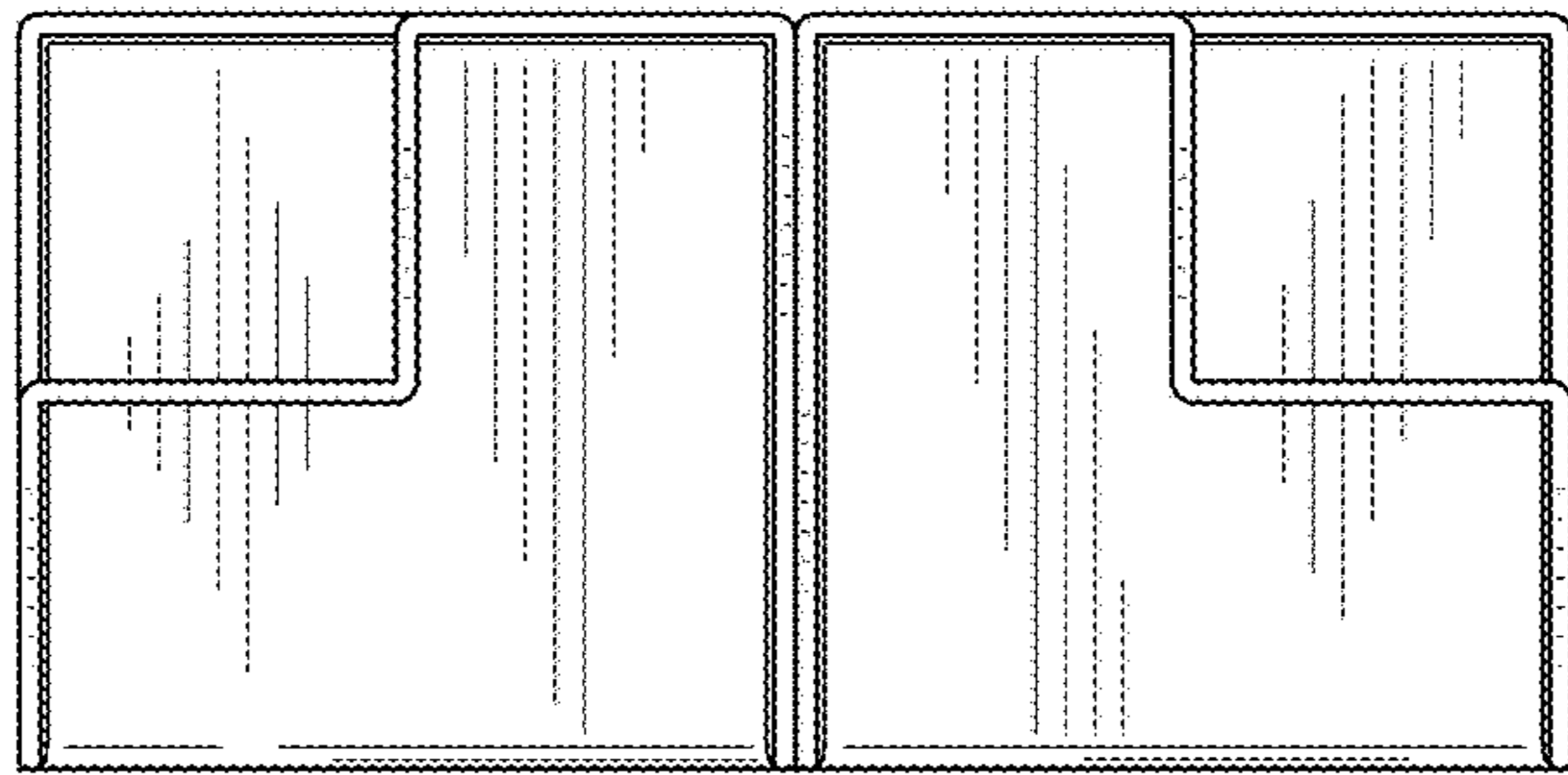

FIG. 7

