



US00D853203S

(12) **United States Design Patent** (10) **Patent No.:** **US D853,203 S**  
**Adam** (45) **Date of Patent:** **\*\* Jul. 9, 2019**

(54) **EASY TO USE CHOPSTICKS**  
(71) Applicant: **Robert Adam**, Kennesaw, GA (US)  
(72) Inventor: **Robert Adam**, Kennesaw, GA (US)  
(\*\*) Term: **15 Years**  
(21) Appl. No.: **29/653,631**  
(22) Filed: **Jun. 18, 2018**

**Related U.S. Application Data**

(63) Continuation-in-part of application No. 29/616,895, filed on Sep. 10, 2017, now abandoned.  
(51) **LOC (11) Cl.** ..... **07-03**  
(52) **U.S. Cl.**  
USPC ..... **D7/642**  
(58) **Field of Classification Search**  
USPC ..... D7/368, 401.2, 642-645, 653-664, 669, D7/675-677, 683, 686-689, 691; D8/107, 300-301; D22/117-118  
CPC ... A01D 9/02; A01D 9/04; A01D 9/06; A47G 21/00; A47G 21/004; A47G 21/005; A47G 21/02; A47G 21/023; A47G 21/04; A47G 21/06; A47G 21/08; A47G 21/10; A47G 21/103; A47J 43/28; A47J 43/281; A47J 43/282; A61F 13/10; A61J 7/0023; B25G 1/00; B25G 1/01; B25G 1/02; B25G 3/00; B65D 75/56; B65D 75/563; B65D 75/566; B67B 7/00; B67B 7/724; B67B 7/73  
See application file for complete search history.

(56) **References Cited**

**U.S. PATENT DOCUMENTS**

2,711,339 A \* 6/1955 McGogy ..... A47G 21/103  
294/11  
D188,125 S \* 6/1960 Zinn ..... 294/99.2

3,239,262 A \* 3/1966 Rines ..... A47G 21/10  
294/99.2  
3,637,248 A \* 1/1972 Arita ..... A47G 21/103  
294/99.2  
3,884,456 A \* 5/1975 Lew ..... A47G 21/103  
267/156  
3,937,510 A \* 2/1976 Lew ..... A47G 21/103  
294/99.2  
D279,852 S 7/1985 Yokoyama  
4,576,408 A \* 3/1986 Maneki ..... A47G 21/10  
24/530  
D311,851 S 12/1990 Allardyce  
4,973,095 A 12/1990 Kunihisa  
D343,096 S \* 1/1994 Lachapelle ..... 294/99.2  
D345,086 S 3/1994 Shapiro  
5,486,029 A \* 1/1996 Kobayashi ..... A47G 21/103  
294/33  
D374,379 S 10/1996 Jee et al.  
D445,312 S 7/2001 Shulman  
D448,627 S 10/2001 Chan  
7,052,061 B2 \* 5/2006 Calagui ..... A47G 21/103  
294/218

(Continued)

*Primary Examiner* — Ricky Pham  
(74) *Attorney, Agent, or Firm* — Moore, Ingram, Johnson & Steele, LLP

(57) **CLAIM**

The ornamental design for easy to use chopsticks, as shown and described.

**DESCRIPTION**

FIG. 1 is a perspective view from the bottom of the chopsticks in accordance with the patent design;  
FIG. 2 is a perspective view from the top;  
FIG. 3 is a view of the front;  
FIG. 4 is a view of the back;  
FIG. 5 is a view of the right side;  
FIG. 6 is a view of the left side;  
FIG. 7 is an enlarged view of the top; and,  
FIG. 8 is an enlarged view of the bottom.

**1 Claim, 4 Drawing Sheets**

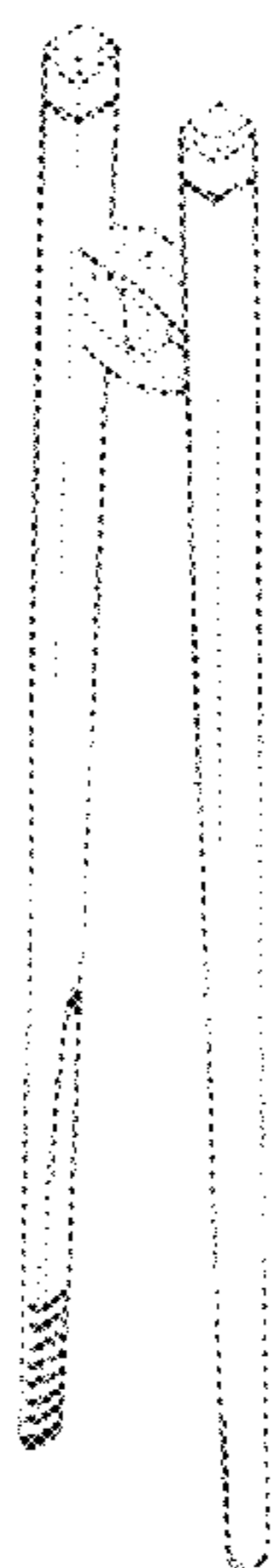

(56)

**References Cited**

U.S. PATENT DOCUMENTS

7,234,745 B1 *	6/2007	Tsai .....	A47G 21/103 294/218
7,513,547 B1 *	4/2009	Liu .....	A47G 21/103 294/218
D657,636 S	4/2012	Carr et al.	
D683,597 S	6/2013	Dixon	
D728,319 S	5/2015	Dixon	
9,468,322 B2 *	10/2016	Woo .....	A47G 21/103

\* cited by examiner

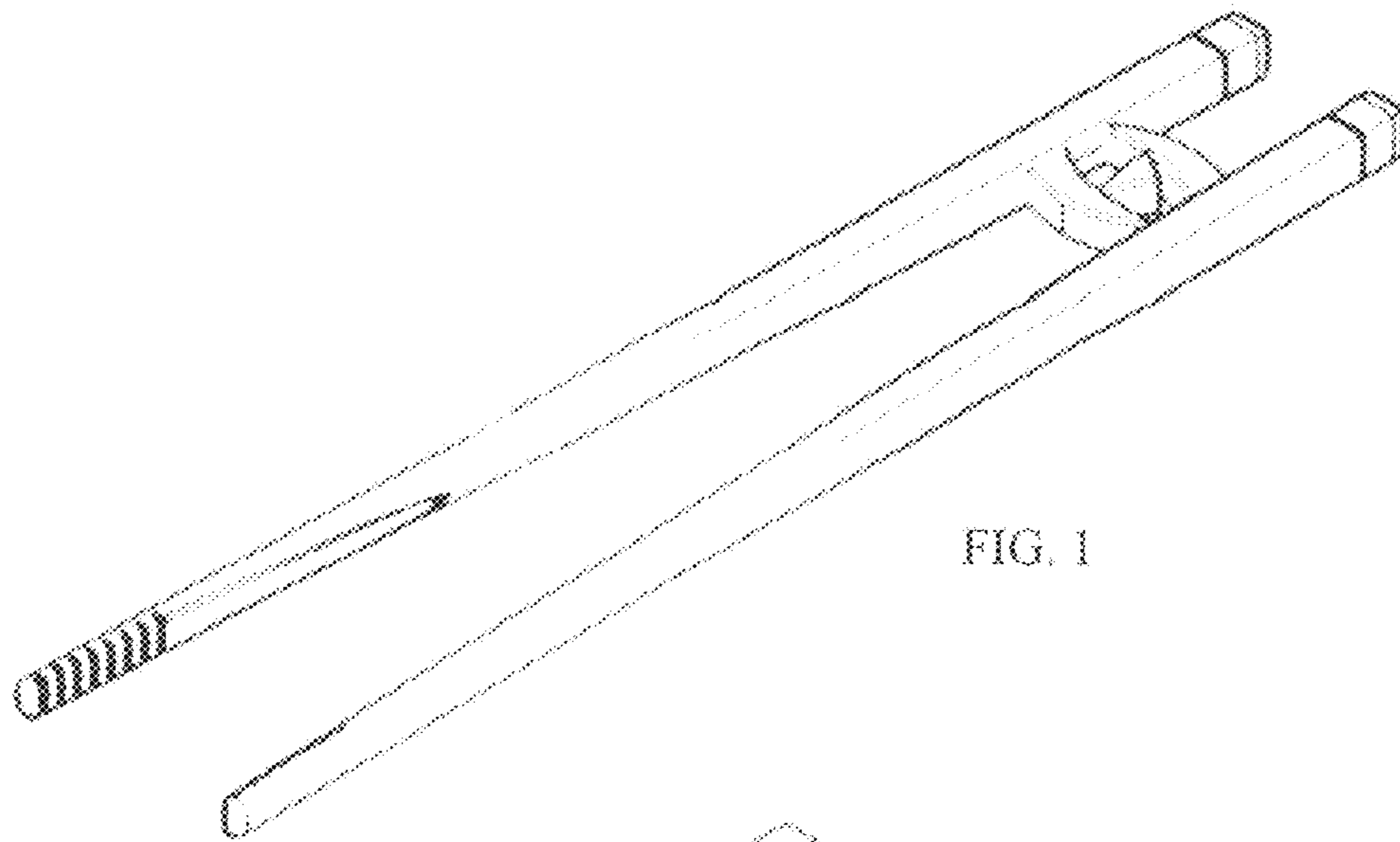

FIG. 1

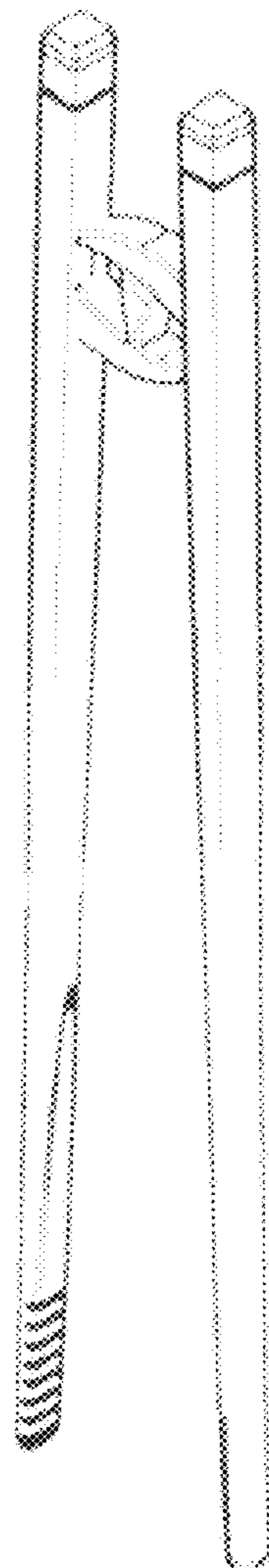

FIG. 2

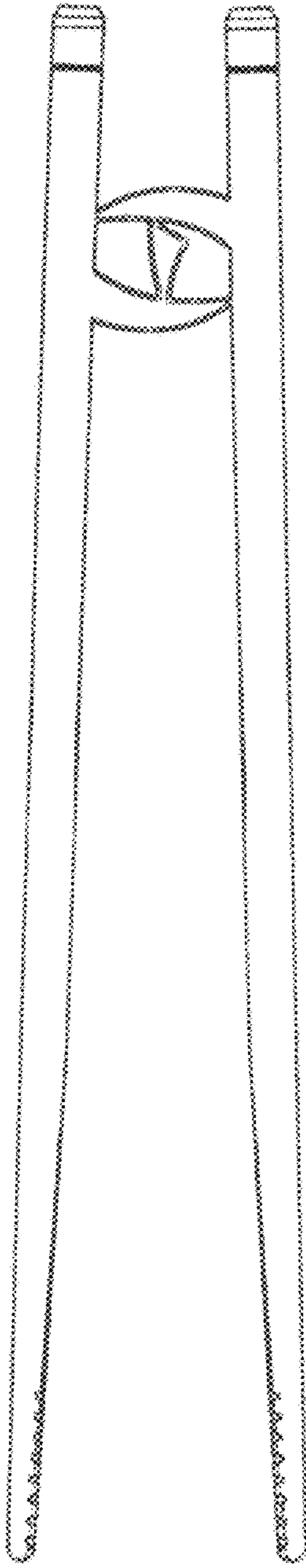

FIG. 3

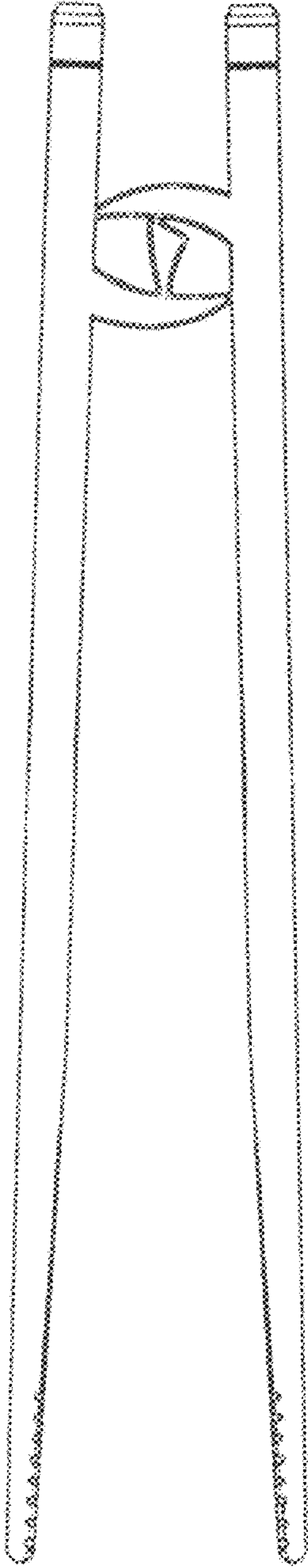

FIG. 4

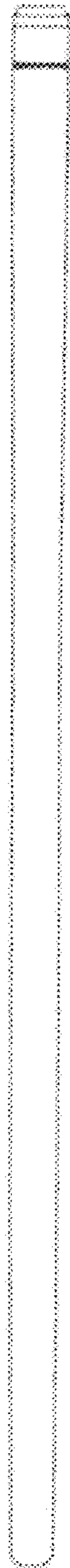

FIG. 5

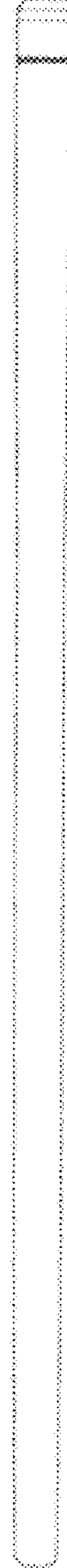

FIG. 6

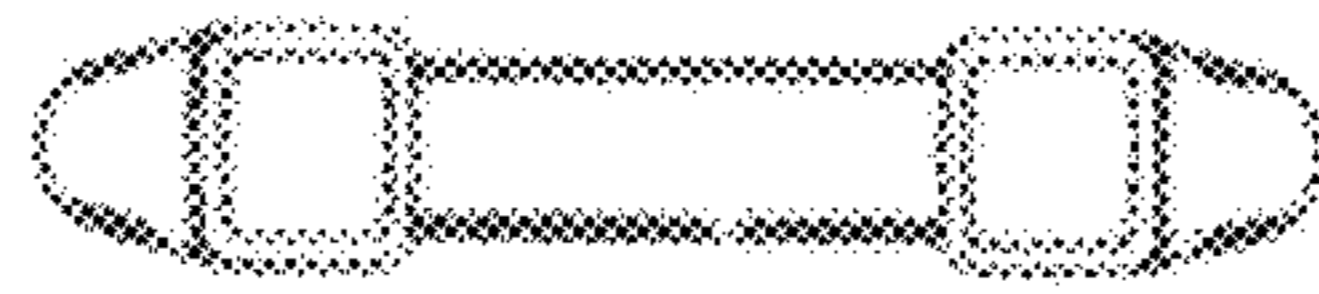

FIG. 7

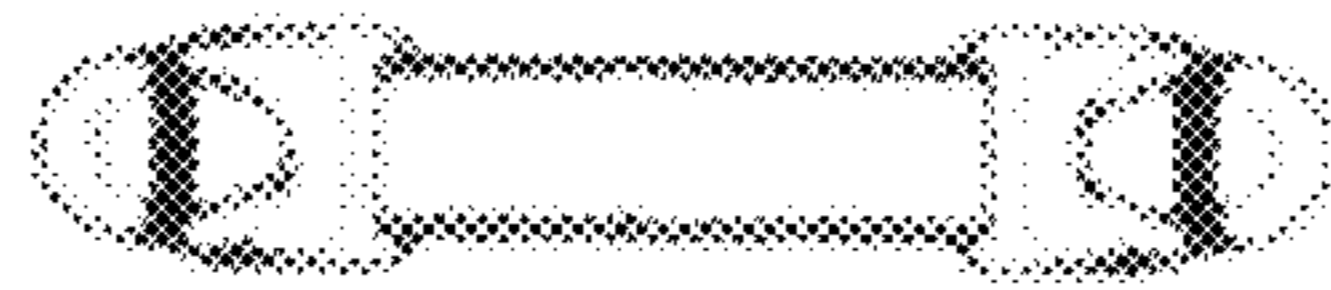

FIG. 8