

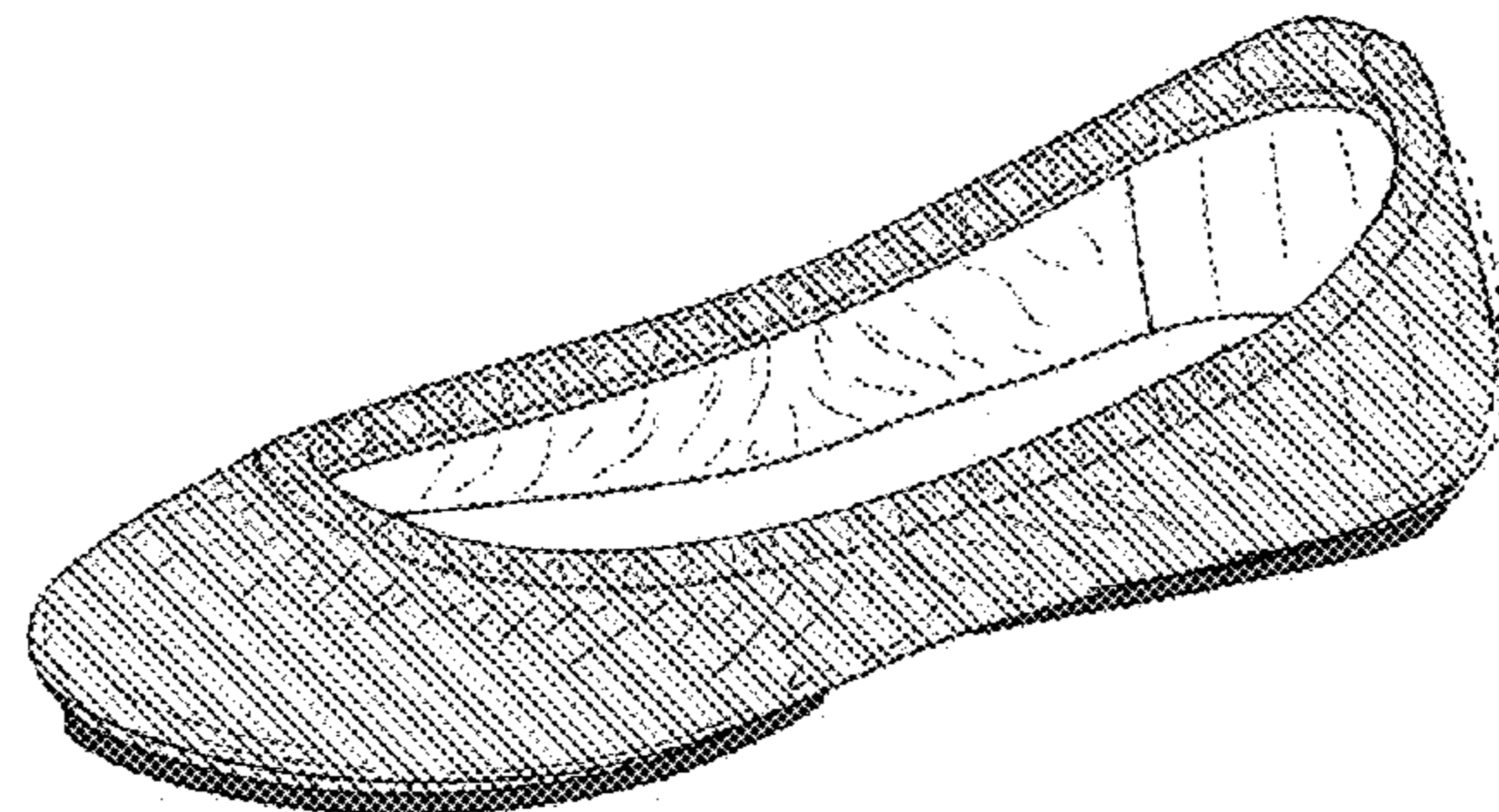

US00D853092S

(12) **United States Design Patent** (10) **Patent No.:** **US D853,092 S**
Gavrieli et al. (45) **Date of Patent:** **** Jul. 9, 2019**

(54) DUAL-SOLE SHOE WITH GREEN OUTPATCH SOLE AND CONTRASTING UPPER	1,208,209 A 12/1916 Prince 1,214,666 A 2/1917 Ford 1,519,009 A 12/1924 Reina 1,525,848 A * 2/1925 Bonaventure A43B 5/12 36/113
(71) Applicant: Gavrieli Brands LLC , Beverly Hills, CA (US)	1,587,377 A 6/1926 Grosjean 1,650,466 A 11/1927 Righter 2,224,590 A 12/1940 Boivin
(72) Inventors: Kfir Gavrieli , Beverly Hills, CA (US); Dikla Gavrieli , Beverly Hills, CA (US)	2,268,777 A 1/1942 Scholl D133,819 S * 9/1942 Harris D2/939 D135,791 S 6/1943 Beebe
(73) Assignee: Gavrieli Brands LLC , Beverly Hills, CA (US)	2,323,563 A 7/1943 Nugent 2,342,882 A 2/1944 Meltzer D141,871 S 7/1945 Braun
(*) Notice: This patent is subject to a terminal dis- claimer.	2,383,585 A 8/1945 Bindner D149,685 S * 5/1948 Sandler D2/935 D150,729 S * 8/1948 Sandler D2/923 D166,090 S * 3/1952 Maling D2/897
(**) Term: 15 Years	2,772,488 A 12/1956 Meltzer 2,904,814 A 9/1959 Scholl 3,148,378 A 9/1964 Tibbitts
(21) Appl. No.: 29/658,153	D200,897 S * 4/1965 Mitchell D2/939 D220,464 S 4/1971 Hayoshi
(22) Filed: Jul. 28, 2018	D247,396 S * 3/1978 Schlerth D2/939 4,412,393 A 11/1983 Terlizzi, Jr. et al. D275,525 S 9/1984 Nakao
Related U.S. Application Data	
(63) Continuation of application No. 29/579,917, filed on Oct. 4, 2016, now Pat. No. Des. 831,312, which is a continuation of application No. 29/509,270, filed on Nov. 14, 2014, now abandoned.	4,674,206 A 6/1987 Lyden D295,692 S * 5/1988 Zuidema D2/950 D300,085 S 3/1989 Ito et al.
(51) LOC (11) Cl. 02-04	RE33,018 E 8/1989 Ostrander 4,899,412 A 2/1990 Ganon
(52) U.S. Cl. USPC D2/939	D316,773 S 5/1991 Valle 5,012,541 A 5/1991 Ganon
(58) Field of Classification Search USPC D2/896, 900, 919-921, 925, 939, 947, D2/950, 969, 971 CPC A43B 21/10; A43B 21/06; A43B 9/14; A43B 1/0045; A43B 13/12; A43B 23/06; A43B 23/07; A43B 1/0036; A43B 7/32 See application file for complete search history.	D339,669 S * 9/1993 Miller D2/939 5,282,326 A 2/1994 Schroer, Jr. et al. 5,421,050 A 6/1995 Laganas 5,699,629 A 12/1997 Munschy 5,746,014 A 5/1998 Tanemoto D420,785 S 2/2000 Perez 6,055,745 A 5/2000 Endoh 6,076,284 A 6/2000 Terlizzi 6,189,239 B1 2/2001 Gasearovic et al. 6,338,207 B1 1/2002 Chang D457,292 S * 5/2002 Sessa D2/949 D461,947 S 8/2002 Merceron 6,588,124 B2 6/2003 Morrone D476,798 S 7/2003 Reynolds et al. D498,041 S 11/2004 McClaskie D500,191 S * 12/2004 Belley D2/969 D501,706 S 2/2005 McClaskie 6,857,203 B2 2/2005 Minden 6,895,693 B2 5/2005 Baruck 6,978,557 B2 12/2005 Lee
(56) References Cited U.S. PATENT DOCUMENTS 249,086 A 11/1881 Pienovi 773,850 A 11/1904 Cooper et al. 830,941 A 9/1906 Walden	



US D853,092 S

Page 2

7,032,327	B1	4/2006	Tartaglia et al.		D690,915	S *	10/2013	Gavrieli	A43B 3/248
7,036,244	B1	5/2006	Finch						D2/939
D527,513	S	9/2006	Della Valle		D696,500	S	12/2013	Hunt	
D529,513	S *	10/2006	Aketa	D15/5	D699,424	S	2/2014	Hamm	
D531,790	S	11/2006	Wurzburg		8,661,714	B2	3/2014	Sussmann	
D534,341	S *	1/2007	Choi	D2/971	8,745,893	B2	6/2014	Kfir Gavrieli et al.	
D542,513	S	5/2007	Amado et al.		8,973,287	B2	3/2015	Shibata	
D556,990	S	12/2007	Cabados		D831,312	S *	10/2018	Gavrieli	D2/939
7,337,558	B2	3/2008	Terlizzi et al.		2002/0078591	A1	6/2002	Morrone	
D567,485	S	4/2008	James		2002/0129519	A1	9/2002	Cahan	
D570,488	S	6/2008	Kirksey et al.		2003/0070319	A1	4/2003	Minden	
D571,084	S	6/2008	Comeau		2003/0121176	A1	7/2003	Baruck	
D571,548	S	6/2008	Seamans		2004/0025377	A1	2/2004	Brannon	
D571,989	S	7/2008	Siegal		2005/0022421	A1	2/2005	Bruckner	
D580,640	S	11/2008	Wurzburg		2005/0115115	A1	6/2005	Lacey	
D582,638	S	12/2008	Ringholz		2005/0217148	A1	10/2005	Connolly et al.	
7,496,982	B2	3/2009	Clark et al.		2005/0262734	A1	12/2005	Cheng	
7,506,459	B2	3/2009	Grisoni et al.		2006/0086005	A1	4/2006	Yerian	
D591,031	S	4/2009	Cofinco		2006/0156576	A1	7/2006	Sloan	
D593,295	S *	6/2009	Belley	D2/969	2007/0074424	A1	4/2007	Lin	
D593,297	S *	6/2009	Belley	D2/969	2007/0204482	A1	9/2007	Gibson-Collinson	
D593,307	S *	6/2009	Belley	D2/969	2007/0204483	A1	9/2007	Kirsch et al.	
D599,093	S *	9/2009	Issler	D2/925	2008/0052964	A1	3/2008	Taylor	
D604,030	S	11/2009	Wilson		2008/0086912	A1	4/2008	Wilkenfeld	
D607,194	S	1/2010	Zagula		2008/0110059	A1	5/2008	Kuramoto et al.	
D610,332	S	2/2010	Raichle		2009/0019732	A1	1/2009	Sussmann	
D610,785	S	3/2010	Smith		2009/0193685	A1	8/2009	Wilson	
D612,140	S	3/2010	Moon		2009/0205222	A1	8/2009	Mclinden	
D612,141	S	3/2010	Moon		2009/0272009	A1	11/2009	Weisner et al.	
7,757,408	B2	3/2010	McClaskie		2010/0011625	A1	1/2010	Percival	
7,694,435	B1	4/2010	Kiser et al.		2010/0018080	A1	1/2010	Smith	
D615,737	S	5/2010	Feller		2010/0050469	A1	3/2010	Chen	
7,735,244	B1	6/2010	Ameche		2010/0095557	A1	4/2010	Jarvis	
7,743,530	B2	6/2010	Truelsen		2010/0115793	A1	5/2010	Kraisosky	
D618,891	S	7/2010	McClaskie		2010/0122475	A1	5/2010	Purrington	
D630,829	S	1/2011	Weisner		2010/0146822	A1	6/2010	MacGregor	
D632,881	S	2/2011	Rosenberg		2010/0212186	A1	8/2010	Cheng	
7,926,203	B2	4/2011	Wilkenfeld		2010/0275462	A1	11/2010	Pucci	
7,966,747	B2	6/2011	Wilkenfeld et al.		2010/0281713	A1	11/2010	Pantazes	
D640,861	S	7/2011	Wilkenfeld		2015/0089843	A1	4/2015	Gavrieli	
8,020,320	B2	9/2011	Gillespie						
8,127,468	B2	3/2012	Morgan						
D657,543	S	4/2012	Bove						
D659,960	S	5/2012	Bizzo						
8,230,619	B2	7/2012	Salvatelli						
D664,755	S	8/2012	Gavrieli et al.						
D665,157	S	8/2012	Wu						
8,240,067	B2	8/2012	Sussmann						
8,245,420	B2	8/2012	Wilson						
D668,027	S	10/2012	Millieret						
D668,438	S	10/2012	Millieret						
D668,847	S *	10/2012	Gavrieli	D2/925					
D668,848	S *	10/2012	Gavrieli	D2/925					
D668,849	S	10/2012	Pozzi						
D668,850	S	10/2012	Pozzi						
D672,542	S	12/2012	Gray et al.						
D676,634	S *	2/2013	Gavrieli	D2/925					
D681,927	S *	5/2013	Gavrieli	D2/925					
D681,928	S *	5/2013	Gavrieli	D2/925					
D681,929	S *	5/2013	Gavrieli	D2/925					
D683,936	S *	6/2013	Gavrieli	D2/925					
8,468,723	B2	6/2013	Malka-Harari						
D686,812	S	7/2013	Kfir Gavrieli et al.						
8,510,975	B2	8/2013	Krikelis						
D688,853	S *	9/2013	Gavrieli	A43B 3/248					
				D2/939					
D688,854	S *	9/2013	Gavrieli	A43B 3/248					
				D2/939					
D688,855	S *	9/2013	Gavrieli	A43B 3/248					
				D2/939					
D689,270	S *	9/2013	Gavrieli	A43B 3/248					
				D2/939					
D689,271	S *	9/2013	Gavrieli	A43B 3/248					
				D2/939					
D689,272	S *	9/2013	Gavrieli	A43B 3/248					
				D2/939					
D690,914	S *	10/2013	Gavrieli	A43B 3/248					
				D2/939					

FOREIGN PATENT DOCUMENTS

DE	20	2006	000230	U1	5/2007
GB			2443937	A	5/2008
GB			2 446 205	A	8/2008
TW			D119165		10/2007

OTHER PUBLICATIONS

Examination Report for AU 341324, 3 pgs., dated Oct. 24, 2012.

Letter from TMI and Associates with Office Action, 2 pgs, dated Sep. 19, 2012 <http://www.payless.com/store/?&TLC=Womens&SLC=WomensNewArrivals&BLC=WomensNewArrivalsNewArrivals&With+Regular&ItemCode=60131&LotNumber=062642&Type=Adult&Popularity=637&Descriptvein>.

Taiwanese Office Action for TW 101300726, 10 pgs., dated Sep. 6, 2012.

“The Love List, Tiefs by Gavrieli—Foldable Ballet Flats,” <http://thelovelist-carly.blogspot.com.au/2010/09/tiefs-by-gavrieli-foldable-ballet.html>, 2 pgs., Sep. 12, 2010.

“Tiefs by Gavrieli,” <http://tiefs.com>, 1 pg., retrieved Mar. 13, 2013 from URL.

“Try It Mummy!, Tiefs by Gavrieli, ” <http://tryitmummy.blogspot.com.au/2010/12/tiefs-by-gavrieli.html>, 3 pgs., Dec. 9, 2010.

“Wearability—Real People Style, What came first, the City Flat or the Tiefs,” <http://wearability.posterous.com/what-came-first-the-city-flat-or-the-tiefs>, 2 pgs., Aug. 29, 2010.

“The Ballet Flat . . . Reinvented; Ballet Flats . . . with a Bonus; Step Into Tiefs; Going Places? Take Tiefs,” <http://web.archive.org/web/2010052004346/http://www.tiefs.com/>; 4 pgs., May 24, 2010.

“Tiefs—Comfortable designer flats you can fit in your purse and wear all day, every day,” <http://web.archive.org/web/20110731151555/http://tiefs.com/>; 6 pgs., Jul. 31, 2011.

“58th Annual Emmy Awards,” http://spoonsforksandfashion.blogspot.com/2006_08_01_archive.html, depicting Nine West flats, 2 pgs., Aug. 1, 2006.

Pictures of Nine West flats sold in 2006, 3 pgs.

“I Love a Good Ballet Flat!,” <http://dressupfiles.com/i-love-a-good-ballet-flat/>, depicting Sue London flats, 3 pgs., Sep. 3, 2010.

Pictures of Sue London flats sold in 2010, 2 pgs.

“Miss Cathie Reviews: The Yosi Samra Foldable Ballet Flat . . . ,” <http://www.misscathie.com/2010/01/miss-cathie-reviews-the-yosi-samra-foldable-ballet-flat/>, depicting Yosi Samra flats, 9 pgs., Jan. 2010.

Pictures of Yosi Samra flats sold in 2010, 2 pgs.

“Goodbye two thousand ten,” http://emmajoyrussell.blogspot.com/2010_12_01_archive.html, depicting Gap flats, 39 pgs., Dec. 1, 2010.

Pictures of Gap flats available for sale in 2010, 9 pgs.

“Our newest design of folding flats—Pink,” <https://fitinclouds.wordpress.com/2010/05/16/our-newest-design-of-folding-flats-pink/>, depicting Fit in Clouds flats, 1 pg., May 16, 2010.

“Fit in Clouds Satin Folding Shoes,” <http://www.goodhousekeeping.com/product-reviews/clothing/best-ballet-flats/fit-in-clouds-satin-foldable-ballet-flats/>, depicting Fit in Clouds flats, 2 pg., Aug. 2013.

Pictures of Fit in Clouds flats available for sale in 2011, 4 pgs.

“Shoes for Standing,” <https://truthinshoes.wordpress.com/2008/07/>, depicting Sam & Libby flats, 2 pgs., Jul. 31, 2008.

“Target Designer Collaboration: Announcing Sam & Libby Shoes for Target,” <http://www.therecessionista.com/2012/11/target-designer-collaboration-announcing-sam-libby-shoes-for-target.html>, depicting Sam & Libby flats, 1 pg., Nov. 26, 2012.

Pictures of Sam & Libby flats available for purchase in 2011, 5 pgs.

“Save your soles with Citisoles ballet flats,” <http://glamazondiaris.com/2009/07/save-your-soles-with-citisoles-ballet-flats/>, depicting Citisoles flats, 3 pgs., Jul. 2009.

Pictures of Citisoles flats available for purchase in 2009, 3 pgs.

“#16 Corso Como Delicious Pumps Review and Giveaway!,” <http://www.mommatoldmeblog.com/2011/01/16-corso-como-delicious-pumps-review.html>, depicting Corso Como flats, 8 pgs., Jan. 16, 2011.

Pictures of Corso Como flats available for sale in 2011, 3 pgs.

“Jil-sander-navy-lead-ballet-flats-product . . . ,” www.ebay.com, depicting Jil Sander flats, 4 pgs., Nov. 2013.

Pictures of Jil Sander flats available for sale in 2011, 3 pgs.

“Spare Soles: Shoes That Roll-up & Fold-up,” <http://herpackinglist.com/2011/01/spare-soles-shoes/>, depicting Spare Soles flats, 2 pgs., Jan. 2011.

Pictures of Spare Soles flats available for sale in 2011, 5 pgs.

Pictures of Roll-Upz by Spare Soles flats available for sale in 2011, 6 pgs.

“The Cutest Blog, Preppy 50 and Loving Lilly, Ballet Flat Delight,” <http://preppy50andlovinglilly.blogspot.com/2011/02/ballet-flat-delight.html>, depicting Henri Bendel flats, 1 pg., Feb. 19, 2011.

Pictures of Henri Bendel flats available for sale in 2011, 4 pgs.

“Mumsnet by parents for parents,” http://www.mumsnet.com/Talk/style_and_beauty/a1612000-Anyone-tried-Redfoot-Flatmates-foldable-ballet-pumps/, depicting Redfoot Flatmates flats, 1 pg., Nov. 14, 2012.

Pictures of Redfoot Flatmates flats available for sale in 2011, 6 pgs.

“Amazon.com: Customer Reviews: Bloch London Women’s Lux Ballet Flat,” <http://www.amazon.com/Bloch-London-Womens-Ballet-Flat/Product-reviews/B004LWP7ZW>, depicting Bloch London flats, 4 pgs., Dec. 11, 2011.

Pictures of Bloch London flats offered for sale in 2011, 11 pgs.

“h&m foldable leopard print flat,” <https://8485shops.wordpress.com/2011/06/16/flats-for-7-bucks/shoe1/>, depicting h&m flats, 2 pgs., Jun. 16, 2011.

Pictures of h&m foldable flats offered for sale in 2011, 4 pgs.

“Seekyt—Juicy Couture Ballet Flats—Are They Worth the Money?,” <http://seekyt.com/juicy-couture-ballet-flats-are-they-worth-the-money/>, 2 pgs., Jun. 3, 2011.

Pictures of Juicy Couture flats offered for sale in 2011, 3 pgs.

“Purse Flats,” <http://purseflats.wordpress.com>, depicting Purse Flats by Erica Wilson, 3 pgs., Jul. 12, 2012.

Pictures of Purse Flats by Erica Wilson offered for sale in 2011, 6 pgs.

“Tieks by Gavrieli—Comfortable, designer flats you can fit in your purse and wear all day . . . ,” <http://web.archive.org/web/20110202210649/http://www.tieks.com/>, 8 pgs., Feb. 2, 2011.

“Carolina M. M. Gonzalez > Tieks by Gavrieli,” http://m2.facebook.com/tieks?v=timeline&filter=2&timecutoff=14064279868&page=17§ionLoadingID=m_timeline_loading_div_1293868799_1262332800_8_17&timeend=1293868799×tart=1262332800&tm=AQDOvqhWQPN_Nbwm&refid=17, 1 pg., Jan. 26, 2010.

“The Shoes Oprah Would Wear to Work (if She Had to Walk),” <http://www.inc.com/30under30/christina-desmarais/kfir-gavrieli-and-elram-gavrieli-founders-of-tieks.html>, 2 pgs., Jul. 2, 2012.

“Tieks by Gavrieli,” http://m2.facebook.com/Tieks?v=timeline&filter=2&timecutoff=1406427986&page=14§ionLoadingID=m_timeline_loading_div_1293868799_1262332800_8_14&timeend=1293868799×tart=1262332800&tm=AQDOvqhWQPN_Nbwm&refid=17, 4 pgs., Jan. 26, 2010.

“Mighty Life List, Sensible Shoes,” <http://mightygirl.com/2010/08/24/sensible-shoes/>, 11 pgs., Aug. 24, 2010.

“Find! Tieks: Fab & sexy flats for fall,” <http://thefabmom.com/2013/08/29/find-tieks-fab-sexy-flats-for-fall/>, 3 pgs., Aug. 29, 2013.

“Step into Tieks,” <http://sliceofpink.typepad.com/blog/2010/09/tieks-1.html>, 5 pgs., Sep. 22, 2010.

“In Need of Flat-Soled Shoes,” <http://www.kellywickham.com/mochamomma/2010/10/4/in-need-of-flat-soled-shoes.html>, 4 pgs., Oct. 3, 2010.

“Say Hello to the Flat Shoes You Need for Fall . . . All 88 of Them!”, Picture of Adam Tucker Shoe/Slipper, <https://www.facebook.com/search/top/?q=adam%20shoes%20slipper>, last accessed Oct. 28, 2016, dated Oct. 1, 2013, 1 page.

Picture of Adam Tucker Rainbow Shoes, <https://www.facebook.com/search/top/?q=adam%20shoes%20rainbow>, last accessed Oct. 28, 2016, dated Aug. 14, 2013, 1 page.

* cited by examiner

Primary Examiner — Dominic V Simone

(74) *Attorney, Agent, or Firm* — Morgan, Lewis & Bockius LLP

(57)

CLAIM

An ornamental design of a dual-sole shoe with green out-patch sole and contrasting upper, as shown and described.

DESCRIPTION

The file of this patent contains at least one drawing executed in color. Copies of this patent with color drawing(s) will be provided by the Office upon request and payment of the necessary fee.

FIG. 1 is a perspective view of yet another embodiment of our new design of a dual-sole shoe with color outpatch sole and contrasting upper, where the portions of the upper and the midsole that contrast with the outpatch sole are indicated using a dotted pattern;

FIG. 2 is a first side view of the design of FIG. 1;

FIG. 3 is a second side view of the design of FIG. 1;

FIG. 4 is a top view of the design of FIG. 1;

FIG. 5 is a bottom view of the design of FIG. 1;

FIG. 6 is a front view of the design of FIG. 1;

FIG. 7 is a back view of the design of FIG. 1;

FIG. 8 is a perspective view of yet another embodiment of our new design of a dual-sole shoe with color outpatch sole and contrasting upper, where the color portions are indicated using the USPTO convention of solid diagonal lines extending from the upper left to the lower right for green, and where the portions of the upper and the midsole that contrast with the outpatch sole are indicated using a dotted pattern;

FIG. 9 is a first side view of the design of FIG. 8;
FIG. 10 is a second side view of the design of FIG. 8;
FIG. 11 is a top view of the design of FIG. 8;
FIG. 12 is a bottom view of the design of FIG. 8;
FIG. 13 is a front view of the design of FIG. 8; and,
FIG. 14 is a back view of the design of FIG. 8.
The broken lines illustrating the half moon patch and the heel stripe in the above described Figures are for illustrative purposes only and form no part of the claimed design.

1 Claim, 12 Drawing Sheets
(5 of 12 Drawing Sheet(s) Filed in Color)

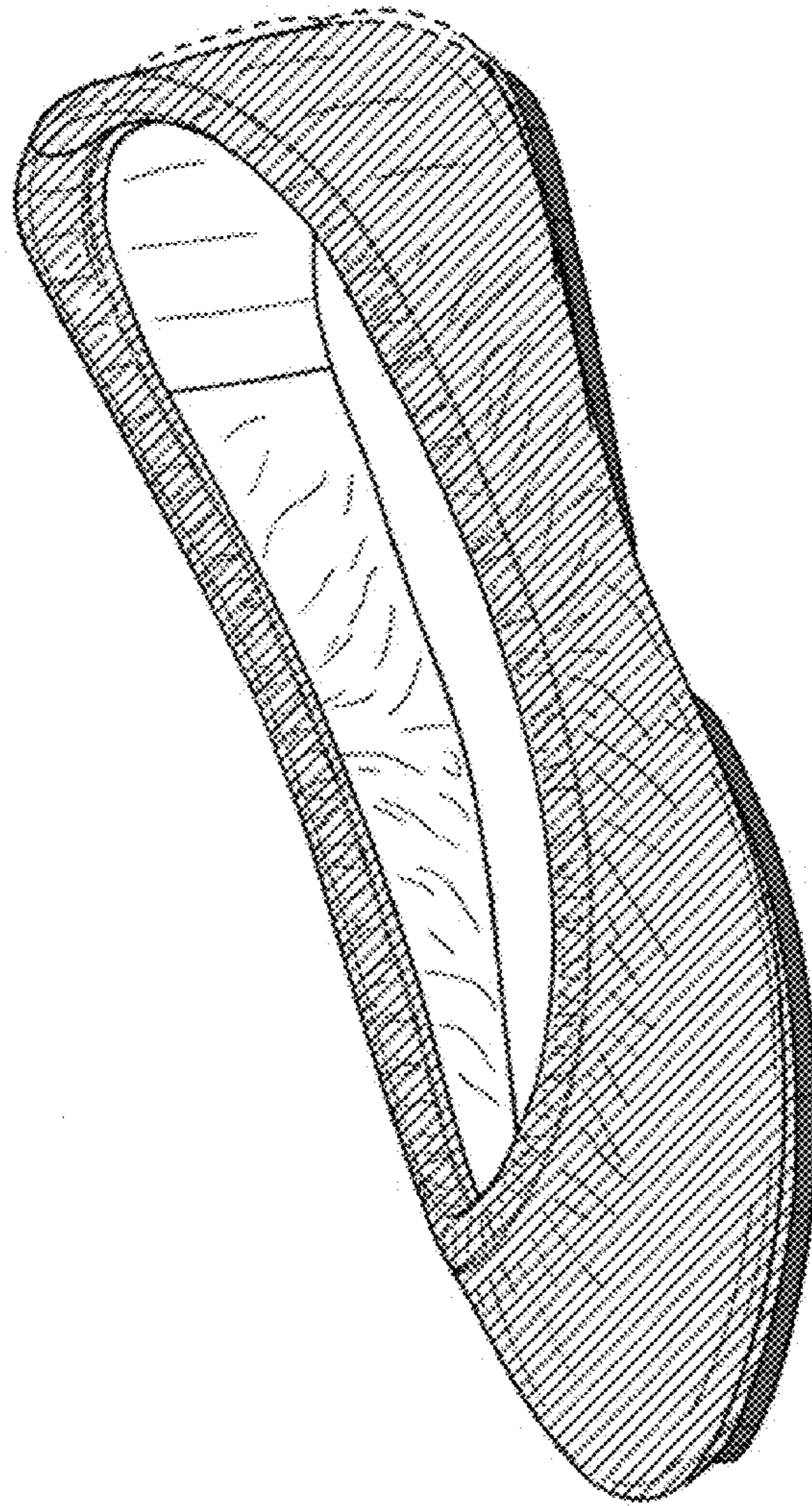

FIG. 1

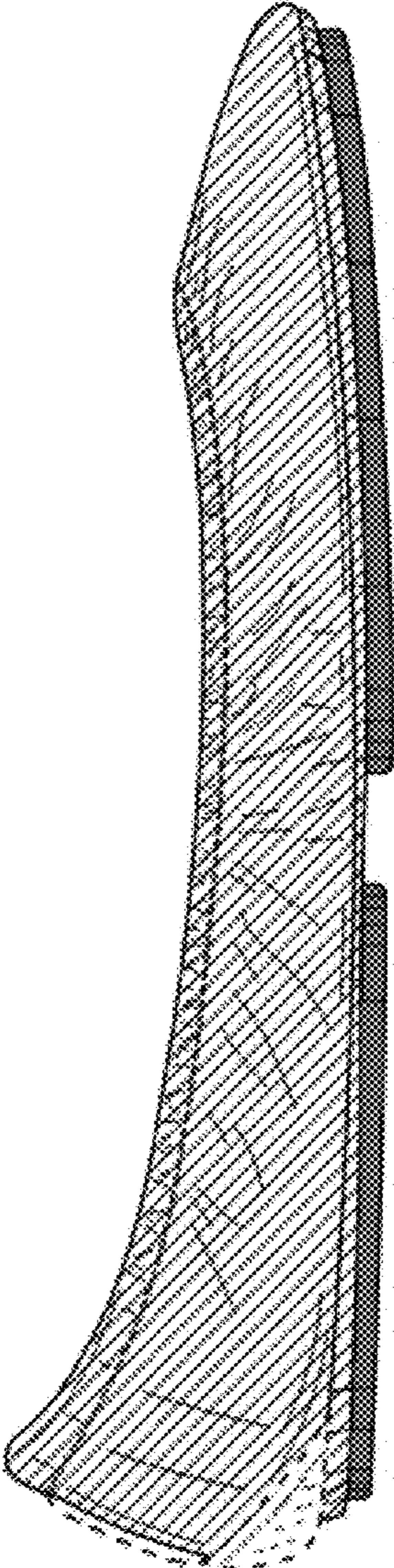

FIG. 2

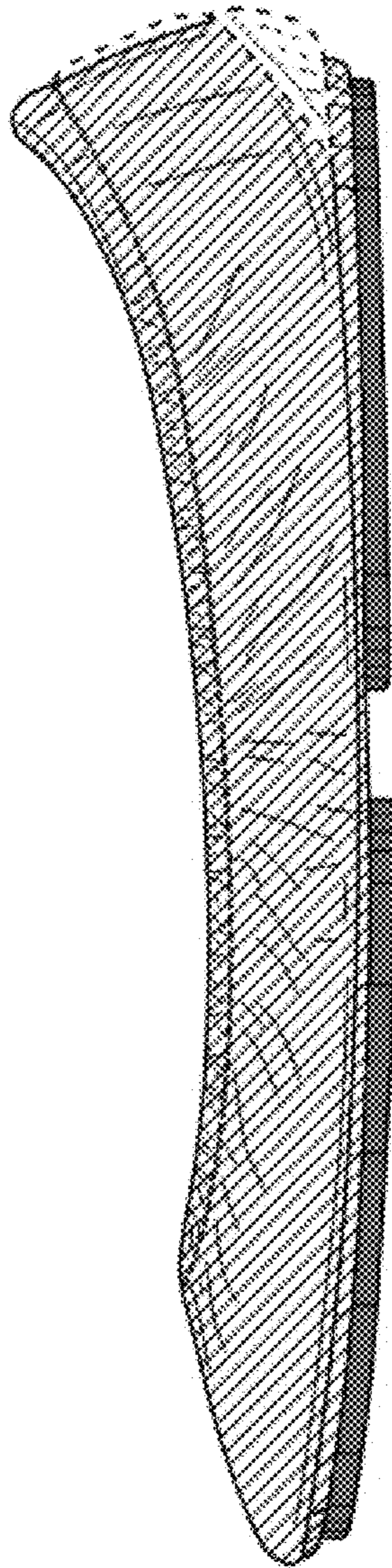

FIG. 3

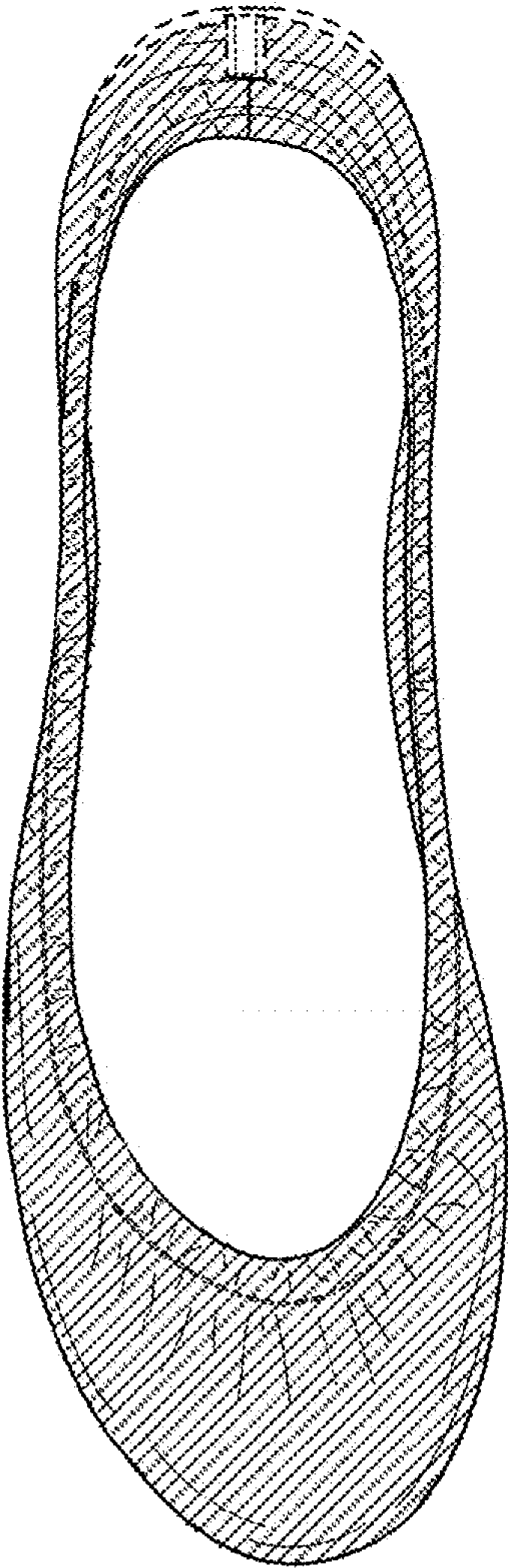

FIG. 4

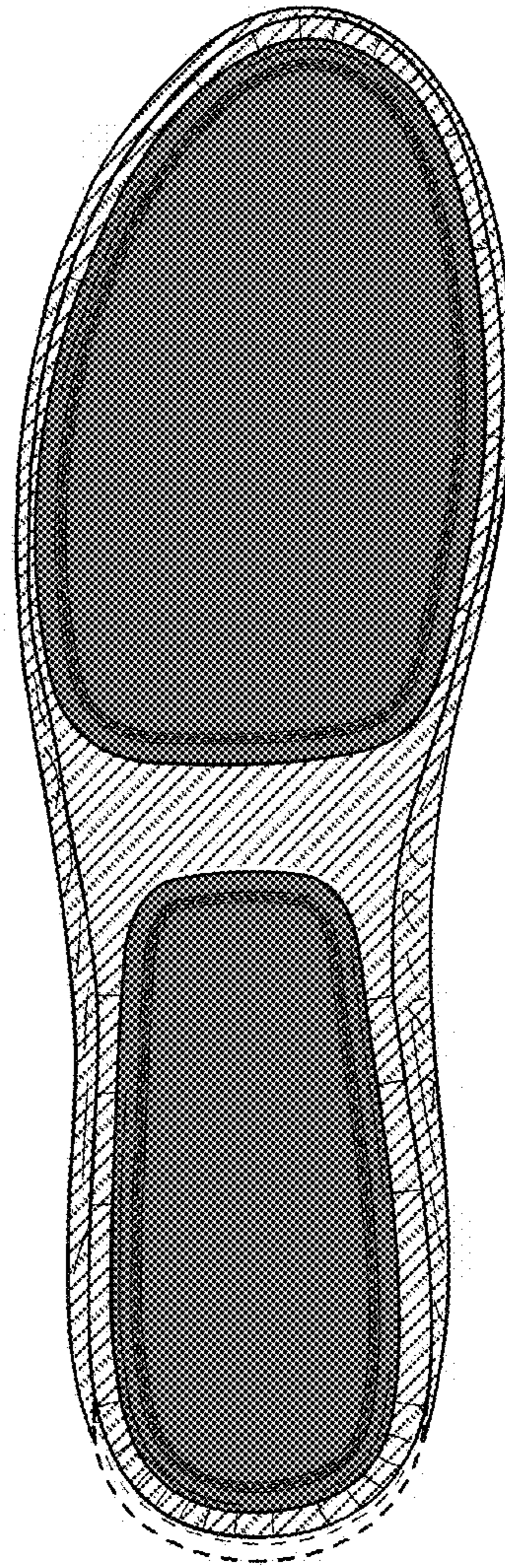

FIG. 5

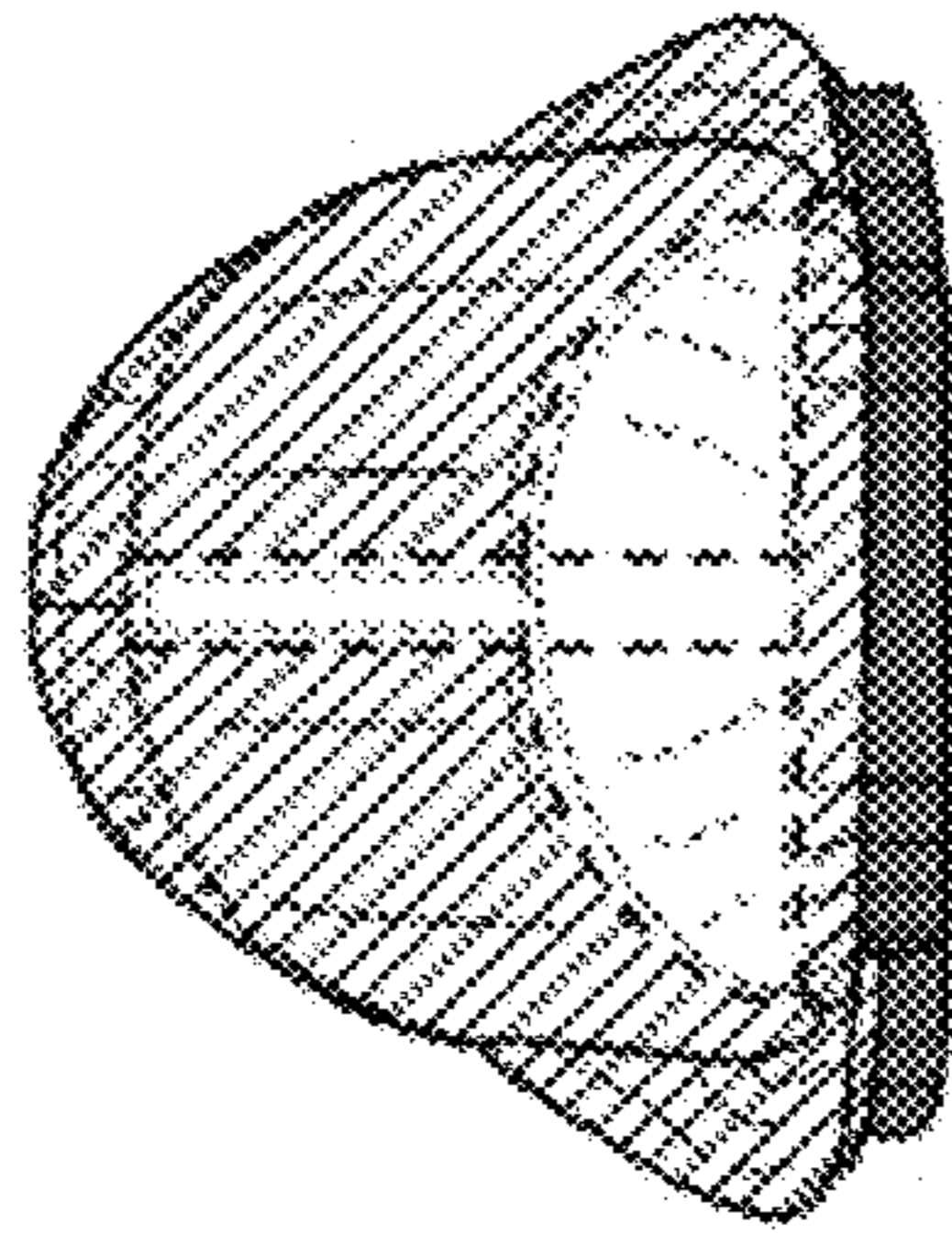

FIG. 7

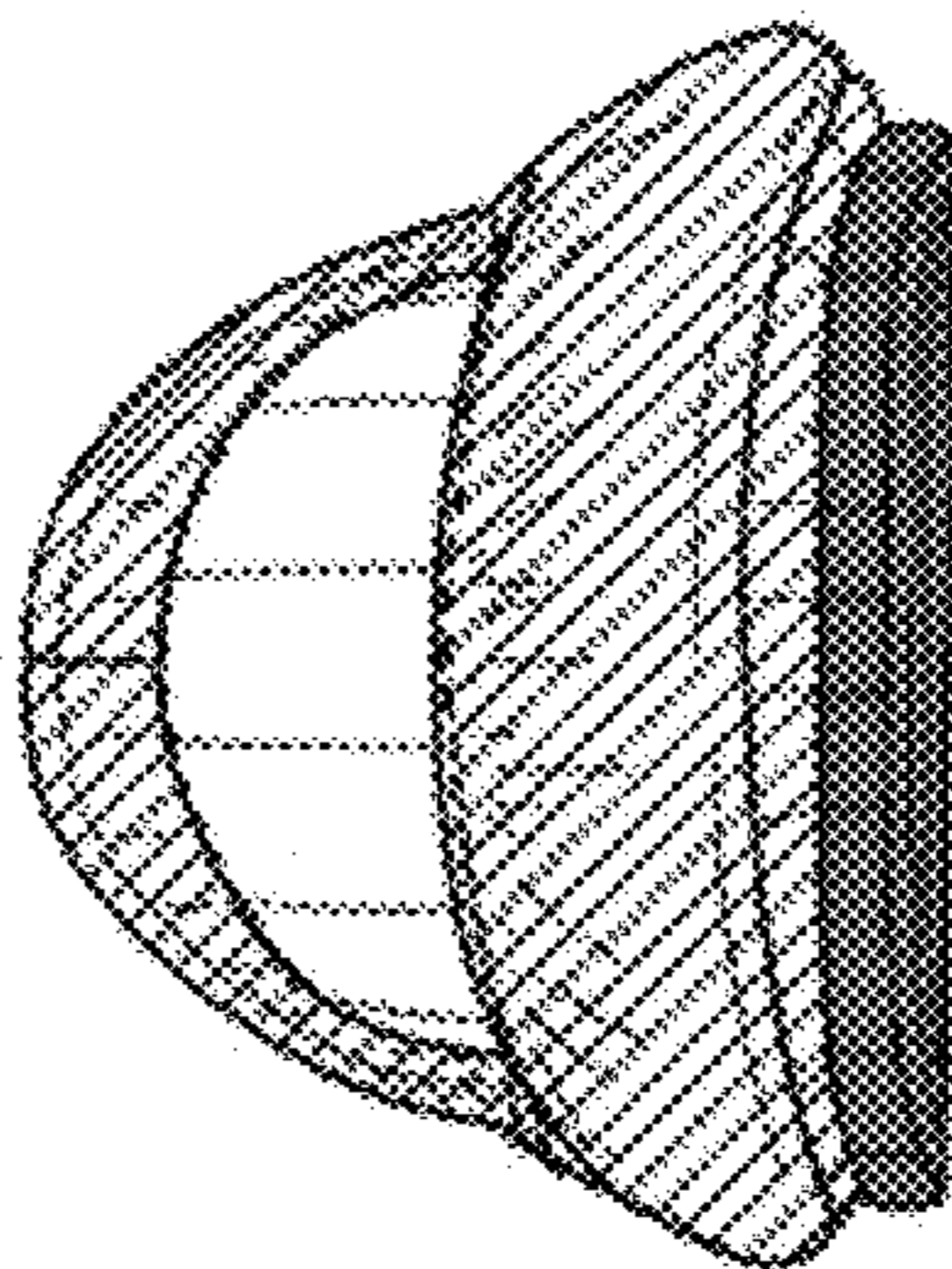

FIG. 6

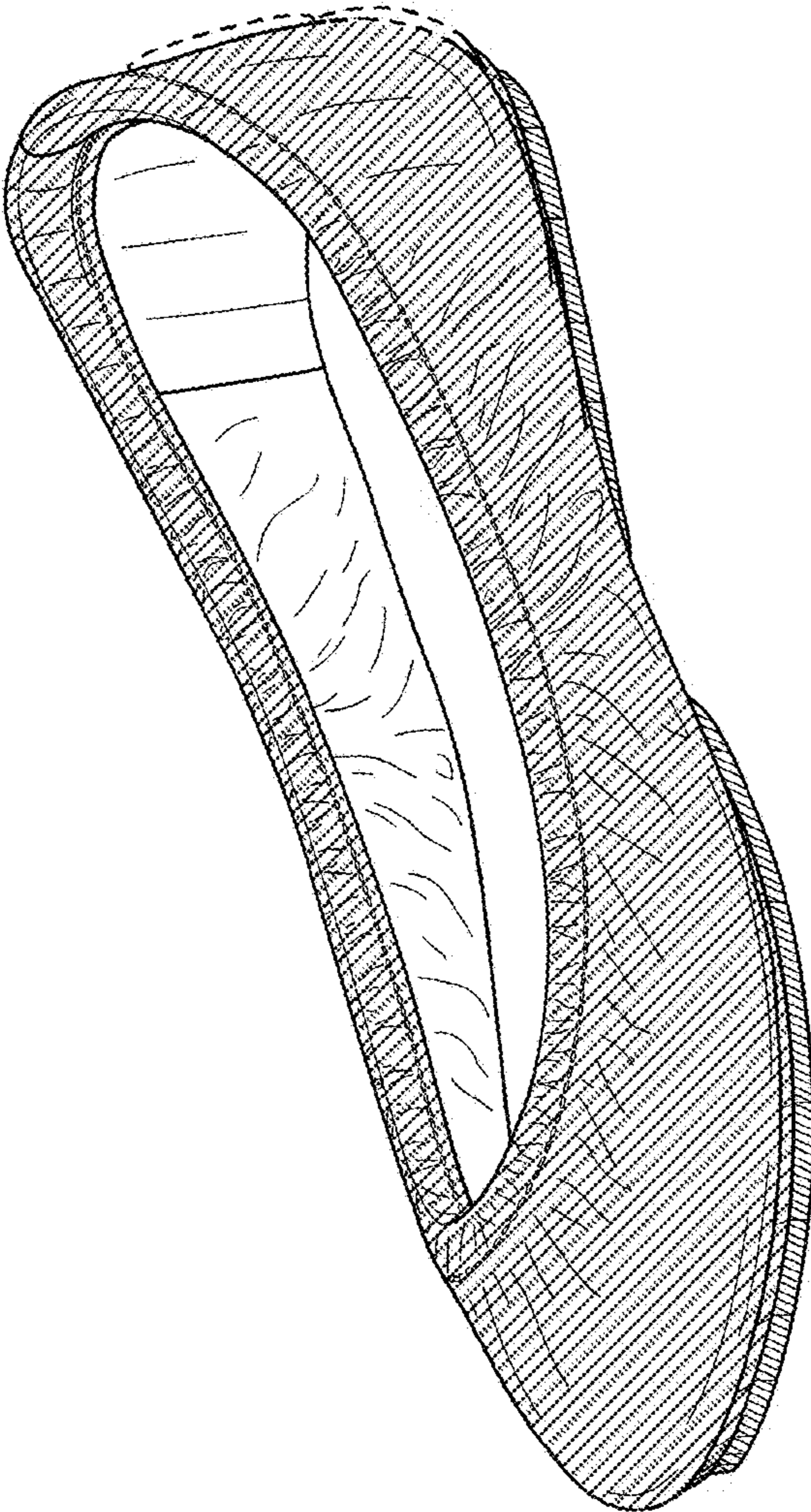

FIG. 8

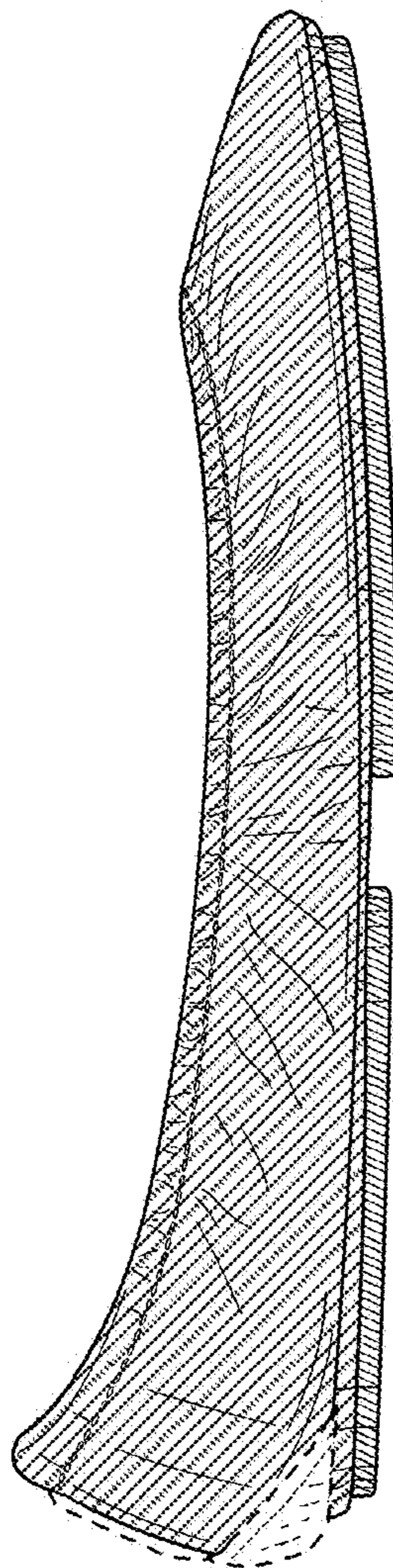

FIG. 9

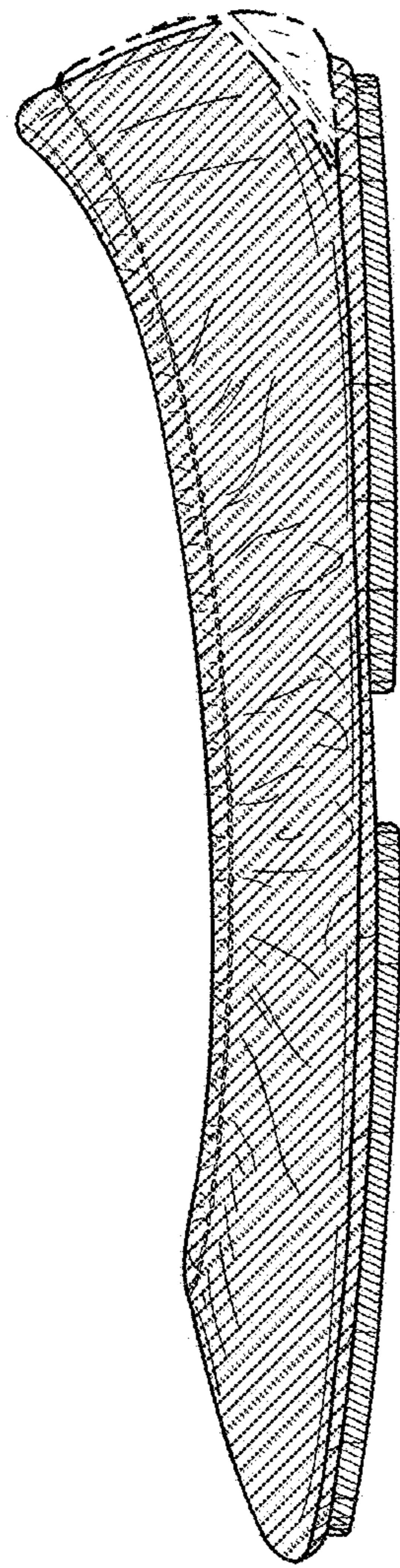

FIG. 10

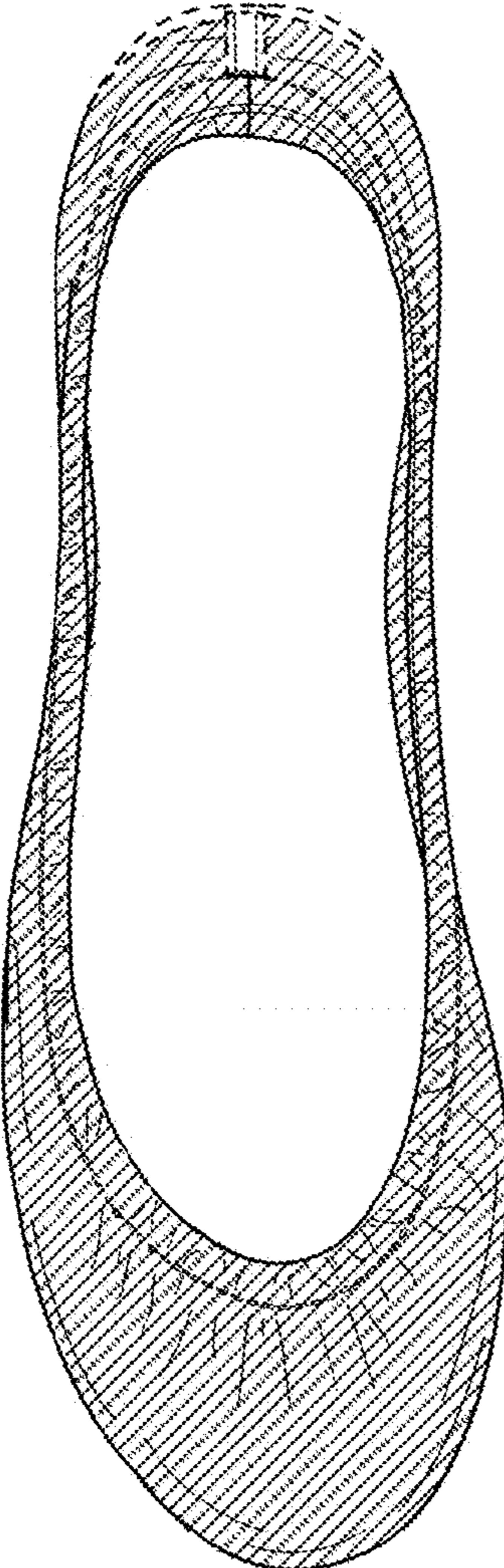

FIG. 11

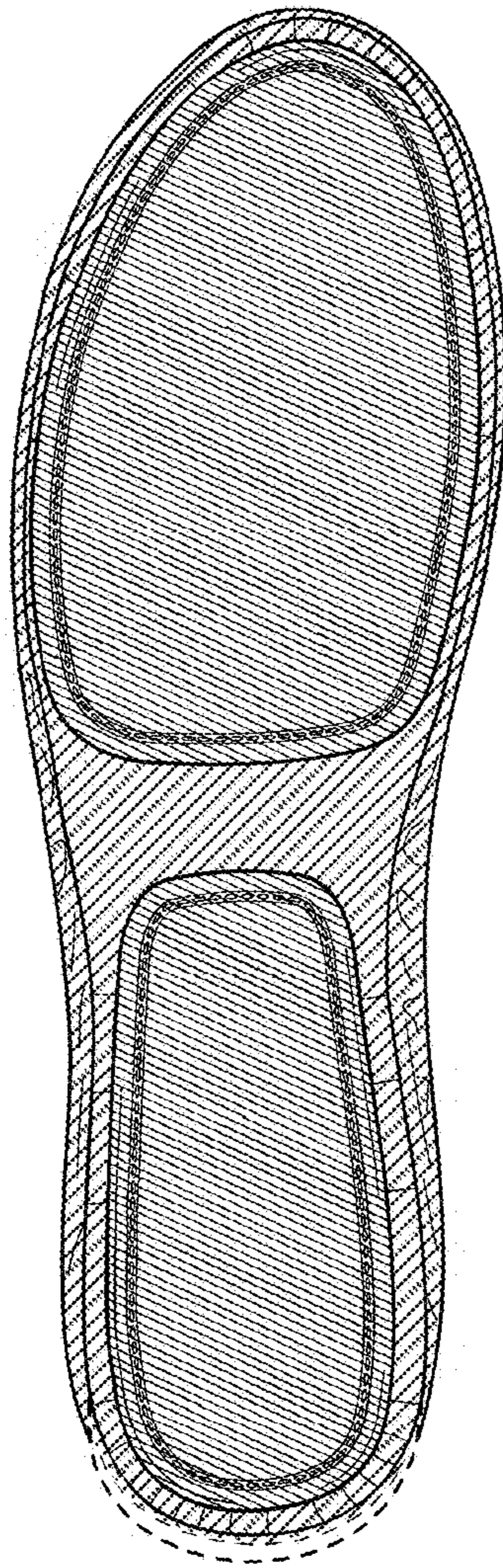

FIG. 12

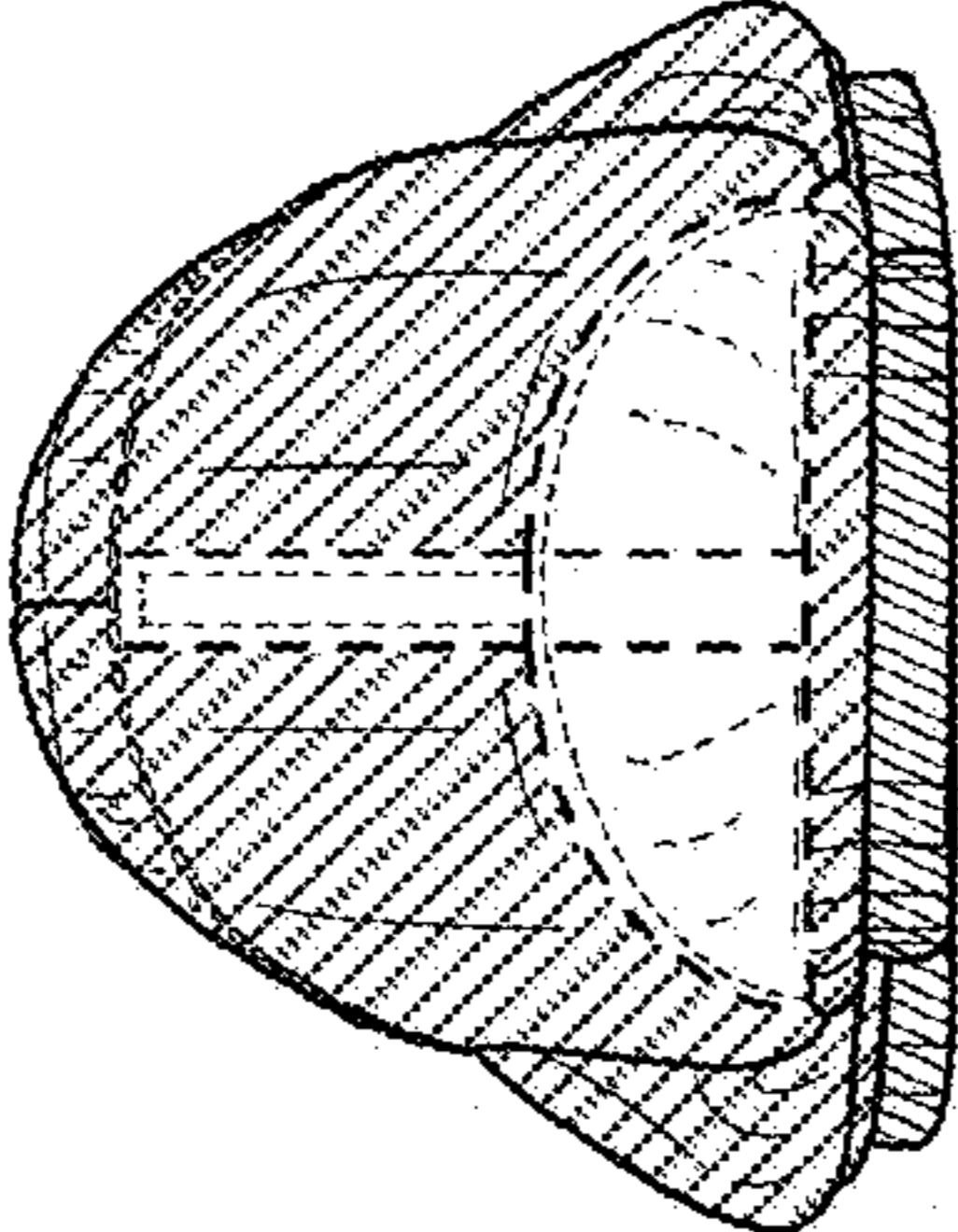

FIG. 14

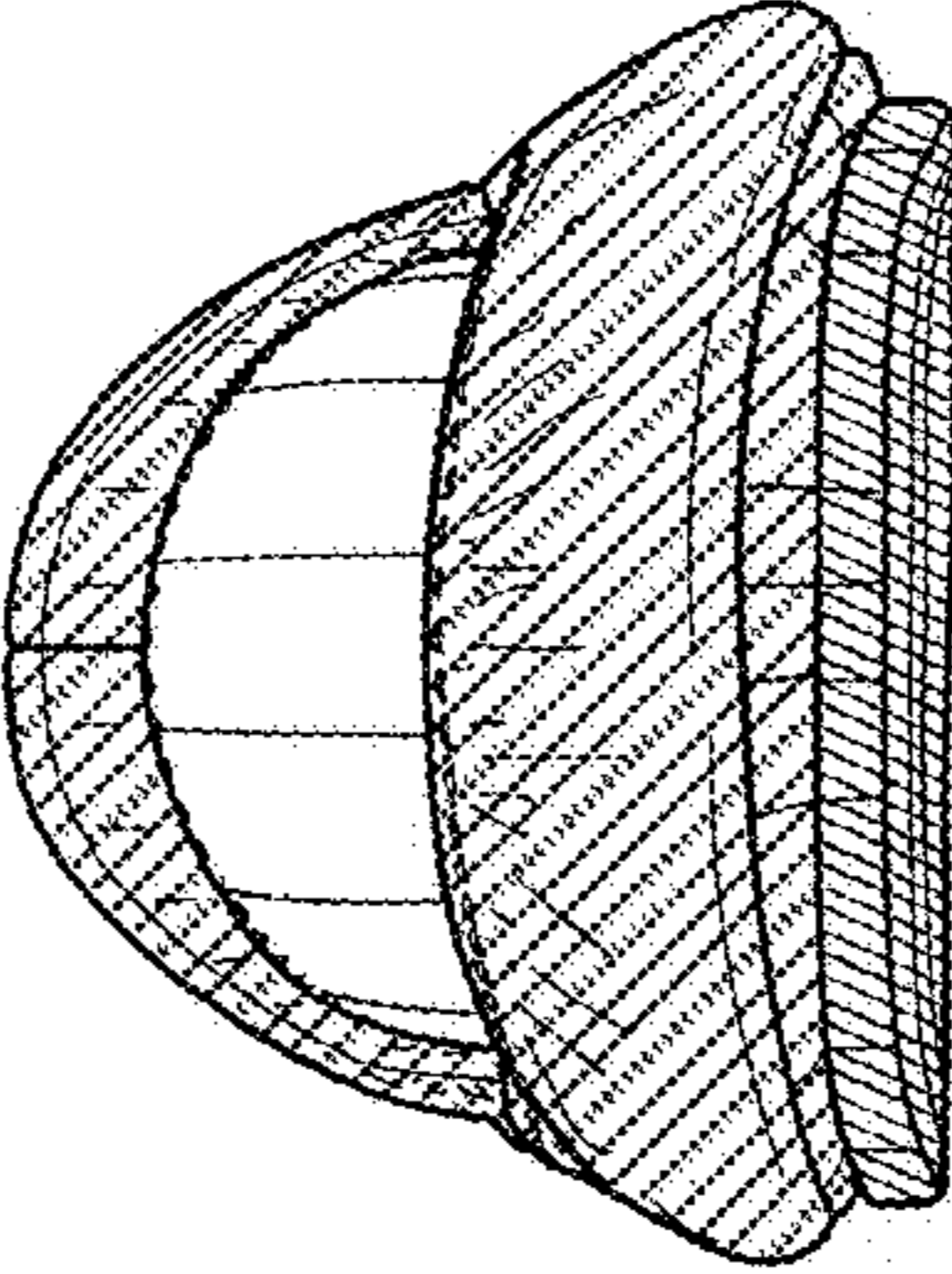

FIG. 13