

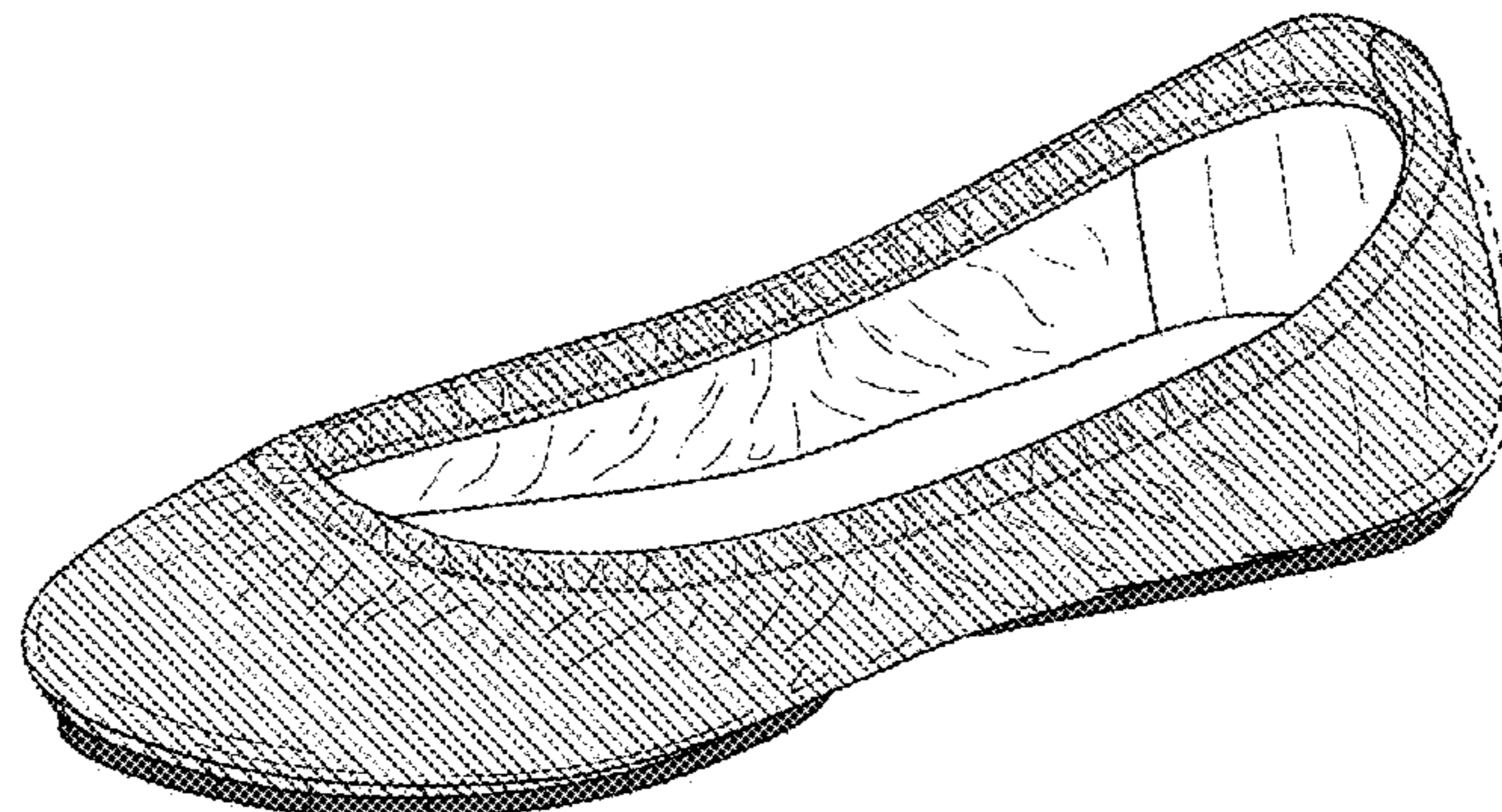

US00D853091S

(12) **United States Design Patent** (10) **Patent No.:** **US D853,091 S**
Gavrieli et al. (45) **Date of Patent:** **** Jul. 9, 2019**

<p>(54) DUAL-SOLE SHOE WITH PURPLE OUTPATCH SOLE AND CONTRASTING UPPER</p> <p>(71) Applicant: Gavrieli Brands LLC, Beverly Hills, CA (US)</p> <p>(72) Inventors: Kfir Gavrieli, Beverly Hills, CA (US); Dikla Gavrieli, Beverly Hills, CA (US)</p> <p>(73) Assignee: Gavrieli Brands LLC, Beverly Hills, CA (US)</p> <p>(*) Notice: This patent is subject to a terminal dis- claimer.</p> <p>(**) Term: 15 Years</p> <p>(21) Appl. No.: 29/658,147</p> <p>(22) Filed: Jul. 28, 2018</p> <p style="text-align: center;">Related U.S. Application Data</p> <p>(63) Continuation of application No. 29/579,917, filed on Oct. 4, 2016, now Pat. No. Des. 831,312, which is a continuation of application No. 29/509,270, filed on Nov. 14, 2014, now abandoned.</p> <p>(51) LOC (11) Cl. 02-04</p> <p>(52) U.S. Cl. USPC D2/939; D2/971</p> <p>(58) Field of Classification Search USPC D2/896, 900, 919-921, 925, 939, 947, D2/950, 969, 971 CPC A43B 21/10; A43B 21/06; A43B 9/14; A43B 1/0045; A43B 13/12; A43B 23/06; A43B 23/07; A43B 1/0036; A43B 7/32 See application file for complete search history.</p> <p>(56) References Cited U.S. PATENT DOCUMENTS</p> <p>249,086 A 11/1881 Pienovi 773,850 A 11/1904 Cooper et al. 830,941 A 9/1906 Walden</p>	<p>1,208,209 A 12/1916 Prince 1,214,666 A 2/1917 Ford 1,519,009 A 12/1924 Reina 1,525,848 A * 2/1925 Bonaventure A43B 5/12 36/113</p> <p>1,587,377 A 6/1926 Grosjean 1,650,466 A 11/1927 Righter 2,224,590 A 12/1940 Odilon 2,268,777 A 1/1942 Scholl D133,819 S * 9/1942 Harris D2/939 D135,791 S 6/1943 Beebe 2,323,563 A 7/1943 Nugent 2,342,882 A 2/1944 Meltzer D141,871 S 7/1945 Braun 2,383,585 A 8/1945 Bindner D149,685 S * 5/1948 Sandler D2/935 D150,729 S * 8/1948 Sandler D2/923 D166,090 S * 3/1952 Maling D2/897 2,772,488 A 12/1956 Meltzer 2,904,814 A 9/1959 Scholl 3,148,378 A 9/1964 Tibbitts D200,897 S * 4/1965 Mitchell D2/939 D220,464 S 4/1971 Hayoshi D247,396 S * 3/1978 Schlerth D2/939 4,412,393 A 11/1983 Terlizzi, Jr. et al. D275,525 S 9/1984 Nakao 4,674,206 A 6/1987 Lyden D295,692 S * 5/1988 Zuidema D2/950 D300,085 S 3/1989 Ito et al. RE33,018 E 8/1989 Ostrander 4,899,412 A 2/1990 Ganon D316,773 S 5/1991 Valle 5,012,541 A 5/1991 Ganon D339,669 S * 9/1993 Miller D2/939 5,282,326 A 2/1994 Schroer, Jr. et al. 5,421,050 A 6/1995 Laganas 5,699,629 A 12/1997 Munschy 5,746,014 A 5/1998 Tanemoto D420,785 S 2/2000 Perez 6,055,745 A 5/2000 Endoh 6,076,284 A 6/2000 Terlizzi 6,189,239 B1 2/2001 Gasparovic et al. 6,338,207 B1 1/2002 Chang D457,292 S * 5/2002 Sessa D2/949 D461,947 S 8/2002 Merceron 6,588,124 B2 6/2003 Morrone D476,798 S 7/2003 Reynolds et al. D498,041 S 11/2004 McClaskie D500,191 S * 12/2004 Belley D2/969 D501,706 S 2/2005 McClaskie 6,857,203 B2 2/2005 Minden 6,895,693 B2 5/2005 Baruck 6,978,557 B2 12/2005 Lee</p>
--	---



US D853,091 S

Page 2

7,032,327	B1	4/2006	Tartaglia et al.		D690,914	S	*	10/2013	Gavrieli	A43B 3/248
7,036,244	B1	5/2006	Finch							D2/939
D527,513	S	9/2006	Della Valle		D690,915	S	*	10/2013	Gavrieli	A43B 3/248
D529,513	S	* 10/2006	Aketa	D15/5						D2/939
D531,790	S	11/2006	Wurzburg		D696,500	S		12/2013	Hunt	
D534,341	S	* 1/2007	Choi	D2/971	D699,424	S		2/2014	Hamm	
D542,513	S	5/2007	Amado et al.		8,661,714	B2		3/2014	Sussmann	
D556,990	S	12/2007	Cabados		8,745,893	B2		6/2014	Gavrieli et al.	
7,337,558	B2	3/2008	Terlizzi et al.		8,973,287	B2		3/2015	Shibata	
D567,485	S	4/2008	James		D831,312	S	*	10/2018	Gavrieli	D2/939
D570,488	S	6/2008	Kirksey et al.		2002/0078591	A1		6/2002	Morrone	
D571,084	S	6/2008	Comeau		2002/0129519	A1		9/2002	Cahan	
D571,548	S	6/2008	Seamans		2003/0070319	A1		4/2003	Minden	
D571,989	S	7/2008	Siegal		2003/0121176	A1		7/2003	Baruck	
D580,640	S	11/2008	Wurzburg		2004/0025377	A1		2/2004	Brannon	
D582,638	S	12/2008	Ringholz		2005/0022421	A1		2/2005	Bruckner	
7,496,982	B2	3/2009	Clark et al.		2005/0115115	A1		6/2005	Lacey	
7,506,459	B2	3/2009	Grisoni et al.		2005/0217148	A1		10/2005	Connolly et al.	
D591,031	S	4/2009	Cofinco		2005/0262734	A1		12/2005	Cheng	
D593,295	S	* 6/2009	Belley	D2/969	2006/0086005	A1		4/2006	Yerian	
D593,297	S	* 6/2009	Belley	D2/969	2006/0156576	A1		7/2006	Sloan	
D593,307	S	* 6/2009	Belley	D2/969	2007/0074424	A1		4/2007	Lin	
D599,093	S	* 9/2009	Issler	D2/925	2007/0204482	A1		9/2007	Gibson-Collinson	
D604,030	S	11/2009	Wilson		2007/0204483	A1		9/2007	Kirsch et al.	
D607,194	S	1/2010	Zagula		2008/0052964	A1		3/2008	Taylor	
D610,332	S	2/2010	Raichle		2008/0086912	A1		4/2008	Wilkenfeld	
D610,785	S	3/2010	Smith		2008/0110059	A1		5/2008	Kuramoto et al.	
D612,140	S	3/2010	Moon		2009/0019732	A1		1/2009	Sussmann	
D612,141	S	3/2010	Moon		2009/0193685	A1		8/2009	Wilson	
7,694,435	B1	4/2010	Kiser et al.		2009/0205222	A1		8/2009	Mclinden	
D615,737	S	5/2010	Feller		2009/0272009	A1		11/2009	Weisner et al.	
7,735,244	B1	6/2010	Ameche		2010/0011625	A1		1/2010	Percival	
7,743,530	B2	6/2010	Truelsen		2010/0018080	A1		1/2010	Smith	
D618,891	S	7/2010	McClaskie		2010/0050469	A1		3/2010	Chen	
7,757,408	B2	7/2010	McClaskie		2010/0095557	A1		4/2010	Jarvis	
D630,829	S	1/2011	Weisner		2010/0115793	A1		5/2010	Kraisosky	
D632,881	S	2/2011	Rosenberg		2010/0122475	A1		5/2010	Purrington	
7,926,203	B2	4/2011	Wilkenfeld		2010/0146822	A1		6/2010	MacGregor	
7,966,747	B2	6/2011	Wilkenfeld et al.		2010/0212186	A1		8/2010	Cheng	
D640,861	S	7/2011	Wilkenfeld		2010/0275462	A1		11/2010	Pucci	
8,020,320	B2	9/2011	Gillespie		2010/0281713	A1		11/2010	Pantazes	
8,127,468	B2	3/2012	Morgan		2015/0089843	A1		4/2015	Gavrieli	
D657,543	S	4/2012	Bove							
D659,960	S	5/2012	Bizzo							
8,230,619	B2	7/2012	Salvatelli							
D664,755	S	8/2012	Gavrieli et al.							
D665,157	S	8/2012	Wu							
8,240,067	B2	8/2012	Sussmann							
8,245,420	B2	8/2012	Wilson							
D668,027	S	10/2012	Millieret							
D668,438	S	10/2012	Millieret							
D668,847	S	* 10/2012	Gavrieli	D2/925						
D668,848	S	* 10/2012	Gavrieli	D2/925						
D668,849	S	10/2012	Pozzi							
D668,850	S	10/2012	Pozzi							
D672,542	S	12/2012	Gray et al.							
D676,634	S	* 2/2013	Gavrieli	D2/925						
D681,927	S	* 5/2013	Gavrieli	D2/925						
D681,928	S	* 5/2013	Gavrieli	D2/925						
D681,929	S	* 5/2013	Gavrieli	A43B 3/248						
										D2/939
D683,936	S	* 6/2013	Gavrieli	D2/925						
8,468,723	B2	6/2013	Malka-Harari							
D686,812	S	7/2013	Gavrieli et al.							
8,510,975	B2	8/2013	Krikelis							
D688,853	S	* 9/2013	Gavrieli	A43B 3/248						
										D2/939
D688,854	S	* 9/2013	Gavrieli	A43B 3/248						
										D2/939
D688,855	S	* 9/2013	Gavrieli	A43B 3/248						
										D2/939
D689,270	S	* 9/2013	Gavrieli	A43B 3/248						
										D2/939
D689,271	S	* 9/2013	Gavrieli	A43B 3/248						
										D2/939
D689,272	S	* 9/2013	Gavrieli	A43B 3/248						
										D2/939

FOREIGN PATENT DOCUMENTS

DE	20	2006	000230	U1	5/2007
GB			2443937	A	5/2008
GB			2 446 205	A	8/2008
TW			D119165		10/2007

OTHER PUBLICATIONS

Examination Report for AU 341324, 3 pgs., dated Oct. 24, 2012.

Letter from TMI and Associates with Office Action, 2 pgs, dated Sep. 19, 2012 <http://www.payless.com/store/?&TLC=Womens&SLC=WomensNewArrival&BLC=WomensNewArrivalsNewArrivals&With-Regular&ItemCode=60131&LotNumber=062642&Type=Adult&Popularity=637&Descriptvein>.

Taiwanese Office Action for TW 101300726, 10 pgs., dated Sep. 6, 2012.

“The Love List, Tiefs by Gavrieli—Foldable Ballet Flats,” <http://thelovelist-carly.blogspot.com.au/2010/09/tiefs-by-gavrieli-foldable-ballet.html>, 2 pgs., Sep. 12, 2010.

“Tiefs by Gavrieli,” <http://tiefs.com>, 1 pg., retrieved Mar. 13, 2013 from URL.

“Try It Mummy!, Tiefs by Gavrieli,” <http://tryitmummy.blogspot.com.au/2010/12/tiefs-by-gavrieli.html>, 3 pgs., Dec. 9, 2010.

“Wearability—Real People Style, What came first, the City Flat or the Tiefs,” <http://wearability.posterous.com/what-came-first-the-city-flat-or-the-tiefs>, 2 pgs., Aug. 29, 2010.

“The Ballet Flat . . . Reinvented; Ballet Flats . . . with a Bonus; Step Into Tiefs; Going Places? Take Tiefs,” <http://web.archive.org/web/2010052004346/http://www.tiefs.com/>; 4 pgs., May 24, 2010.

“Tiefs—Comfortable designer flats you can fit in your purse and wear all day, every day,” <http://web.archive.org/web/20110731151555/http://tiefs.com/>; 6 pgs., Jul. 31, 2011.

“58th Annual Emmy Awards,” http://spoonsforkandfashion.blogspot.com/2006_08_01_archive.html, depicting Nine West flats, 2 pgs., Aug. 1, 2006.

Pictures of Nine West flats sold in 2006, 3 pgs.

“I Love a Good Ballet Flat!,” <http://dressupfiles.com/i-love-a-good-ballet-flat/>, depicting Sue London flats, 3 pgs., Sep. 3, 2010.

Pictures of Sue London flats sold in 2010, 2 pgs.

“Miss Cathie Reviews: The Yosi Samra Foldable Ballet Flat . . .,” <http://www.misscathie.com/2010/01/miss-cathie-reviews-the-yosi-samra-foldable-ballet-flat/>, depicting Yosi Samra flats, 9 pgs., Jan. 2010.

Pictures of Yosi Samra flats sold in 2010, 2 pgs.

“Goodbye two thousand ten,” http://emmajoyrussell.blogspot.com/2010_12_01_archive.html, depicting Gap flats, 39 pgs., Dec. 1, 2010.

Pictures of Gap flats available for sale in 2010, 9 pgs.

“Our newest design of folding flats-Pink,” <https://fitinclouds.wordpress.com/2010/05/16/our-newest-design-of-folding-flat-pink/>, depicting Fit in Clouds flats, 1 pg., May 16, 2010.

“Fit in Clouds Satin Folding Shoes,” <http://www.goodhousekeeping.com/product-reviews/clothing/best-ballet-flats/fit-in-clouds-satin-foldable-ballet-flats/>, depicting Fit in Clouds flats, 2 pg., Aug. 2013.

Pictures of Fit in Clouds flats available for sale in 2011, 4 pgs.

“Shoes for Standing,” <https://truthinshoes.wordpress.com/2008/07/>, depicting Sam & Libby flats, 2 pgs., Jul. 31, 2008.

“Target Designer Collaboration: Announcing Sam & Libby Shoes for Target,” <http://www.therecessionista.com/2012/11/target-designer-collaboration-announcing-sam-libby-shoes-for-target.html>, depicting Sam & Libby flats, 1 pg., Nov. 26, 2012.

Pictures of Sam & Libby flats available for purchase in 2011, 5 pgs.

“Save your soles with Citisoles ballet flats,” <http://glamazondiaries.com/2009/07/save-your-soles-with-citisoles-ballet-flats/>, depicting Citisoles flats, 3 pgs., Jul. 2009.

Pictures of Citisoles flats available for purchase in 2009, 3 pgs.

“#16 Corso Como Delicious Pumps Review and Giveaway!,” <http://www.mommatoldmeblog.com/2011/01/16-corso-como-delicious-pumps-review.html>, depicting Corso Como flats, 8 pgs., Jan. 16, 2011.

Pictures of Corso Como flats available for sale in 2011, 3 pgs.

“Jil-sander-navy-lead-ballet-flats-product . . .,” www.ebay.com, depicting Jil Sander flats, 4 pgs., Nov. 2013.

Pictures of Jil Sander flats available for sale in 2011, 3 pgs.

“Spare Soles: Shoes That Roll-up & Fold-up,” <http://herpackinglist.com/2011/01/spare-soles-shoes/>, depicting Spare Soles flats, 2 pgs., Jan. 2011.

Pictures of Spare Soles flats available for sale in 2011, 5 pgs.

Pictures of Roll-Upz by Spare Soles flats available for sale in 2011, 6 pgs.

“The Cutest Blog, Preppy 50 and Loving Lilly, Ballet Flat Delight,” <http://preppy50andlovinglilly.blogspot.com/2011/02/ballet-flat-delight.html>, depicting Henri Bendel flats, 1 pg., Feb. 19, 2011.

Pictures of Henri Bendel flats available for sale in 2011, 4 pgs.

“Mumsnet by parents for parents,” http://www.mumsnet.com/Talk/style_and_beauty/a1612000-Anyone-tried-Redfoot-Flatmates-foldable-ballet-pumps/, depicting Redfoot Flatmates flats, 1 pg., Nov. 14, 2012.

Pictures of Redfoot Flatmates flats available for sale in 2011, 6 pgs.

“Amazon.com: Customer Reviews: Bloch London Women’s Lux Ballet Flat,” <http://www.amazon.com/Bloch-London-Womens-Ballet-Flat/product-reviews/B004LWP7YW>, depicting Bloch London flats, 4 pgs., Dec. 11, 2011.

Pictures of Bloch London flats offered for sale in 2011, 11 pgs.

“h&m foldable leopard print flat,” <https://8485shops.wordpress.com/2011/06/16/flats-for-7-bucks/shoe1/>, depicting h&m flats, 2 pgs., Jun. 16, 2011.

Pictures of h&m foldable flats offered for sale in 2011, 4 pgs.

“Seekyt—Juicy Couture Ballet Flats—Are They Worth The Money?,” <http://seekyt.com/juicy-couture-ballet-flats-are-they-worth-the-money/>, 2 pgs., Jun. 3, 2011.

Pictures of Juicy Couture flats offered for sale in 2011, 3 pgs.

“Purse Flats,” <http://purseflats.wordpress.com>, depicting Purse Flats by Erica Wilson, 3 pgs., Jul. 12, 2012.

Pictures of Purse Flats by Erica Wilson offered for sale in 2011, 6 pgs.

“Tieks by Gavrieli—Comfortable, designer flats you can fit in your purse and wear all day . . .,” <http://web.archive.org/web/20110202210649/http://www.tieks.com/>, 8 pgs., Feb. 2, 2011.

“Carolina M. M. Gonzalez > Tieks by Gavrieli,” http://m2.facebook.com/Tieks?v=timeline&filter=2&timecutoff=1406427986&page=17§ionLoadingID=m_timeline_loading_div_1293868799_1262332800_8_17&timeend=1293868799×tart=1262332800&tm=AQDOvqhWQPN_Nbwm&refid=17, 1 pg., Jan. 26, 2010.

“The Shoes Oprah Would Wear to Work (if She Had to Walk),” <http://www.inc.com/30under30/christina-desmarais/kfir-gavrieli-and-elram-gavrieli-founders-of-tieks.html>, 2 pgs., Jul. 2, 2012.

“Tieks by Gavrieli,” http://m2.facebook.com/Tieks?v=timeline&filter=2&timecutoff=1406427986&page=14§ionLoadingID=m_timeline_loading_div_1293868799_1262332800_8_14&timeend=1293868799×tart=1262332800&tm=AQDOvqhWQPN_Nbwm&refid=17, 4 pgs., Jan. 26, 2010.

“Mighty Life List, Sensible Shoes,” <http://mightygirl.com/2010/08/24/sensible-shoes/>, 11 pgs., Aug. 24, 2010.

“Find! Tieks: Fab & sexy flats for fall,” <http://thefabmom.com/2013/08/29/find-tieks-fab-sexy-flats-for-fall/>, 3 pgs., Aug. 29, 2013.

“Step into Tieks,” <http://sliceofpink.typepad.com/blog/2010/09/tieks-1.html>, 5 pgs., Sep. 22, 2010.

“In Need of Flat-Soled Shoes,” <http://www.kellywickham.com/mochamomma/2010/10/4/in-need-of-flat-soled-shoes.html>, 4 pgs., Oct. 3, 2010.

“Say Hello to the Flat Shoes You Need for Fall . . . All 88 of Them!”, Picture of Adam Tucker Shoe/Slipper, <http://www.facebook.com/search/top/?q=adam%20shoes%20slipper>, last accessed Oct. 28, 2016, dated Oct. 1, 2013, 1 page.

Picture of Adam Tucker Rainbow Shoes, <https://www.facebook.com/search/top/?q=adam%20shoes%20rainbow>, last accessed Oct. 28, 2016, dated Aug. 14, 2013, 1 page.

* cited by examiner

Primary Examiner — Dominic V Simone

(74) *Attorney, Agent, or Firm* — Morgan, Lewis & Bockius LLP

(57)

CLAIM

An ornamental design of a dual-sole shoe with purple outpatch sole and contrasting upper, as shown and described.

DESCRIPTION

The file of this patent contains at least one drawing executed in color. Copies of this patent with color drawing(s) will be provided by the Office upon request and payment of the necessary fee.

FIG. 1 is a perspective view of an embodiment of our new design of a dual-sole shoe with color outpatch sole and contrasting upper, where the portions of the upper and the midsole that contrast with the outpatch sole are indicated using a dotted pattern;

FIG. 2 is a first side view of the design of FIG. 1;

FIG. 3 is a second side view of the design of FIG. 1;

FIG. 4 is a top view of the design of FIG. 1;

FIG. 5 is a bottom view of the design of FIG. 1;

FIG. 6 is a front view of the design of FIG. 1;

FIG. 7 is a back view of the design of FIG. 1;

FIG. 8 is a perspective view of another embodiment of our new design of a dual-sole shoe with color outpatch sole and contrasting upper, where the color portions are indicated using the USPTO convention of dashed vertical lines for violet or purple, and where the portions of the upper and the midsole that contrast with the outpatch sole are indicated using a dotted pattern;

FIG. 9 is a first side view of the design of FIG. 8;
FIG. 10 is a second side view of the design of FIG. 8;
FIG. 11 is a top view of the design of FIG. 8;
FIG. 12 is a bottom view of the design of FIG. 8;
FIG. 13 is a front view of the design of FIG. 8;
FIG. 14 is a back view of the design of FIG. 8; and,
FIG. 15 is a perspective view of yet another embodiment of our new design of a dual-sole shoe with color outpatch sole and contrasting upper, where the portions of the upper and the midsole that contrast with the outpatch sole are indicated using a dotted pattern.
The broken lines illustrating the half moon patch and the heel stripe in the above described Figures are for illustrative purposes only and form no part of the claimed design.

1 Claim, 12 Drawing Sheets
(5 of 12 Drawing Sheet(s) Filed in Color)

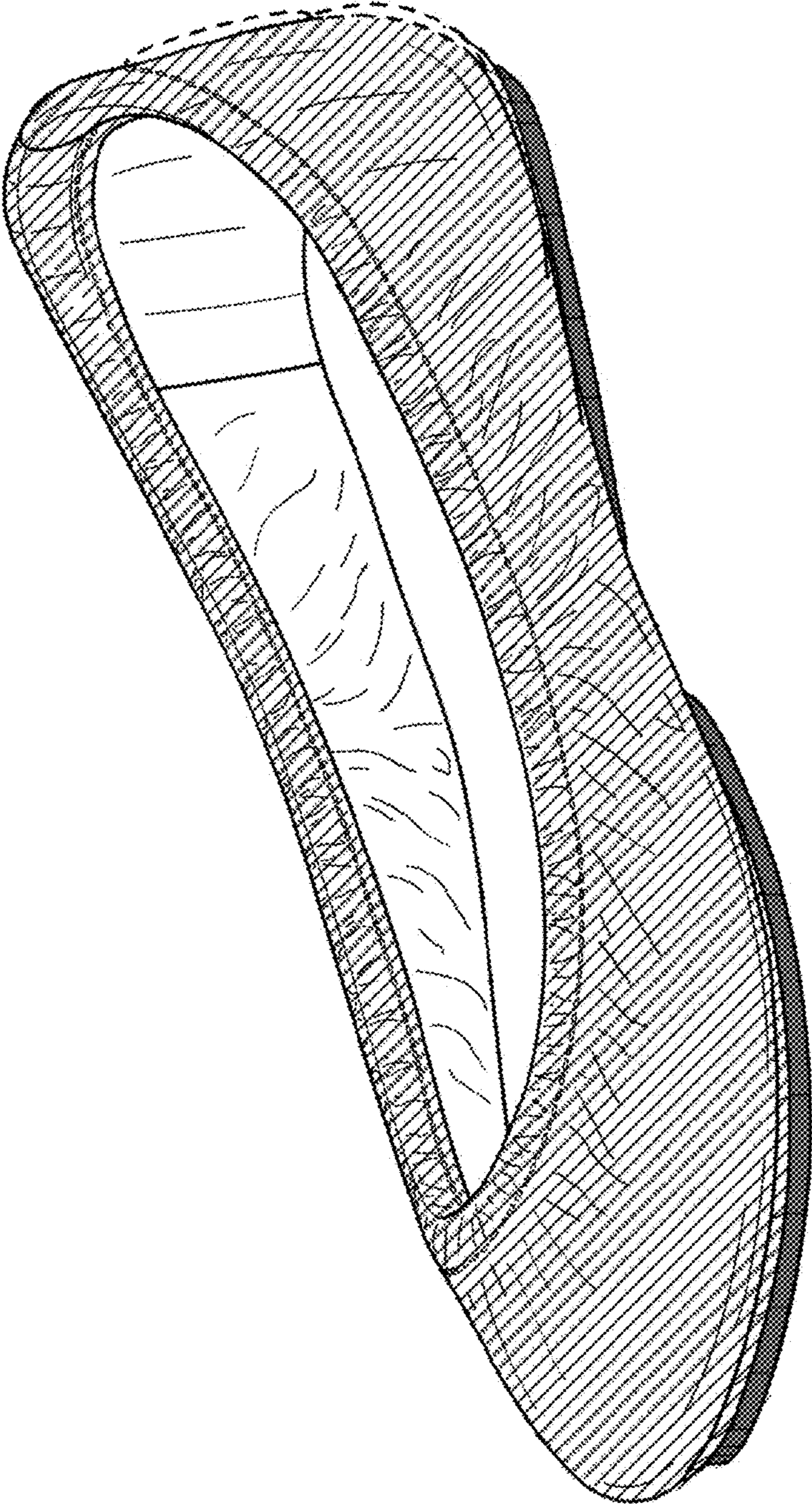

FIG. 1

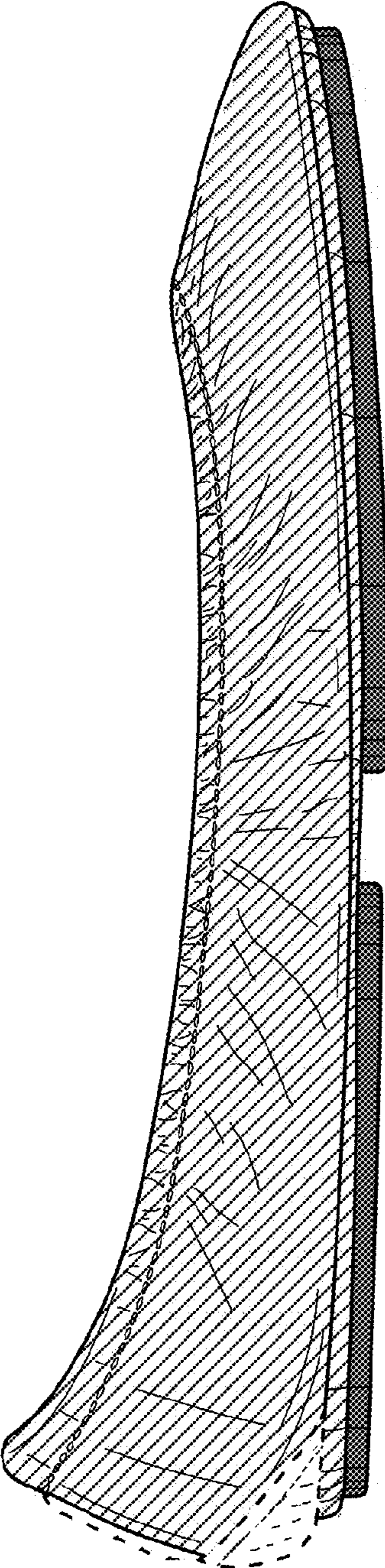

FIG. 2

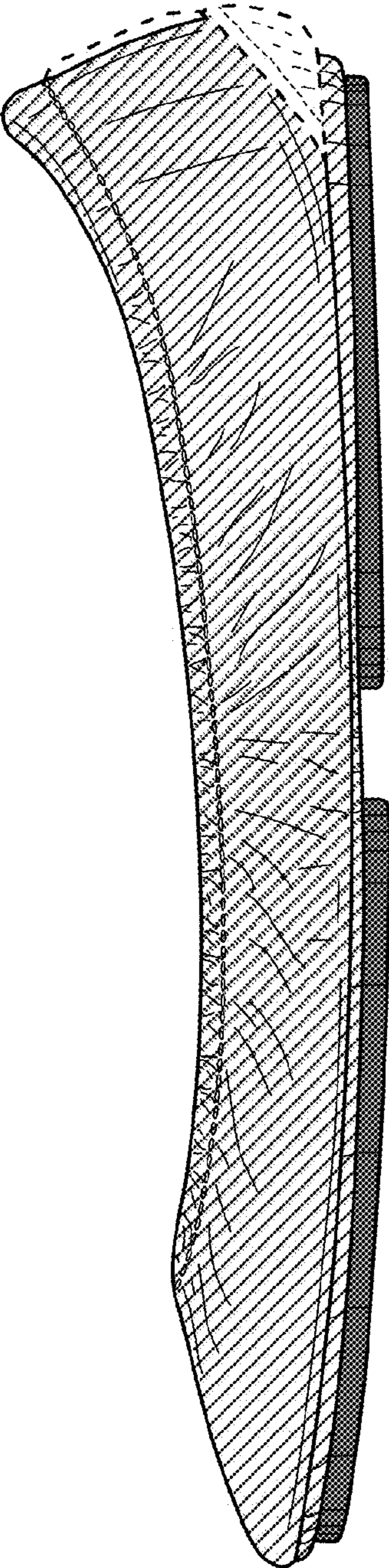

FIG. 3

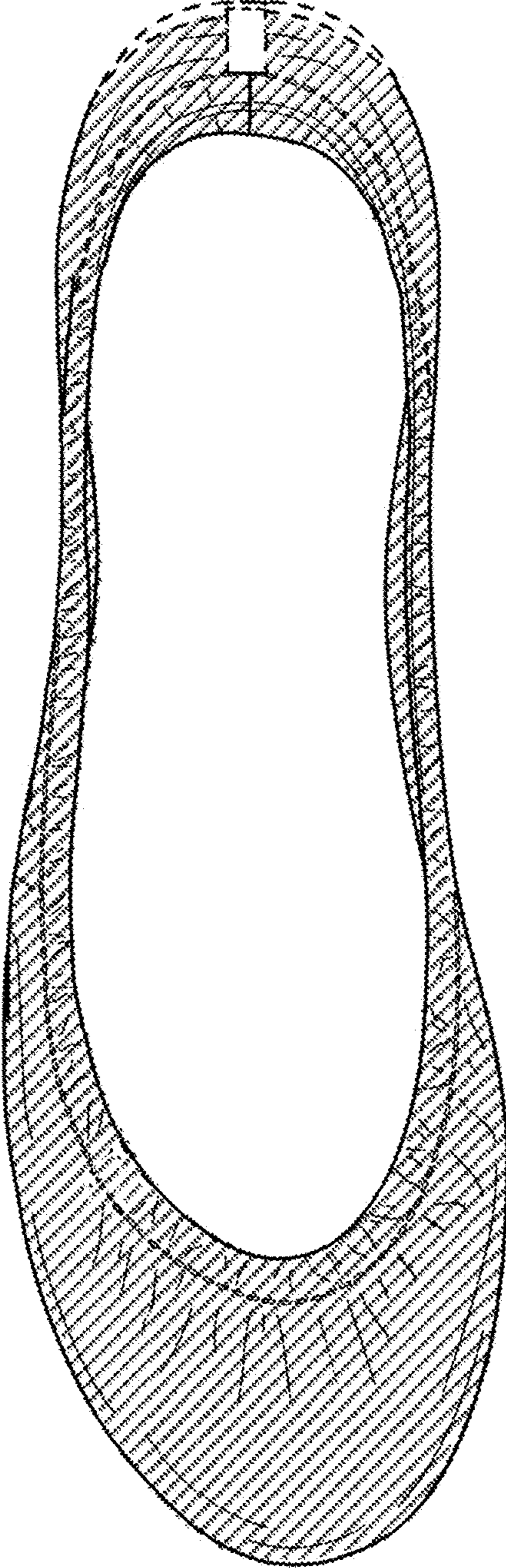

FIG. 4

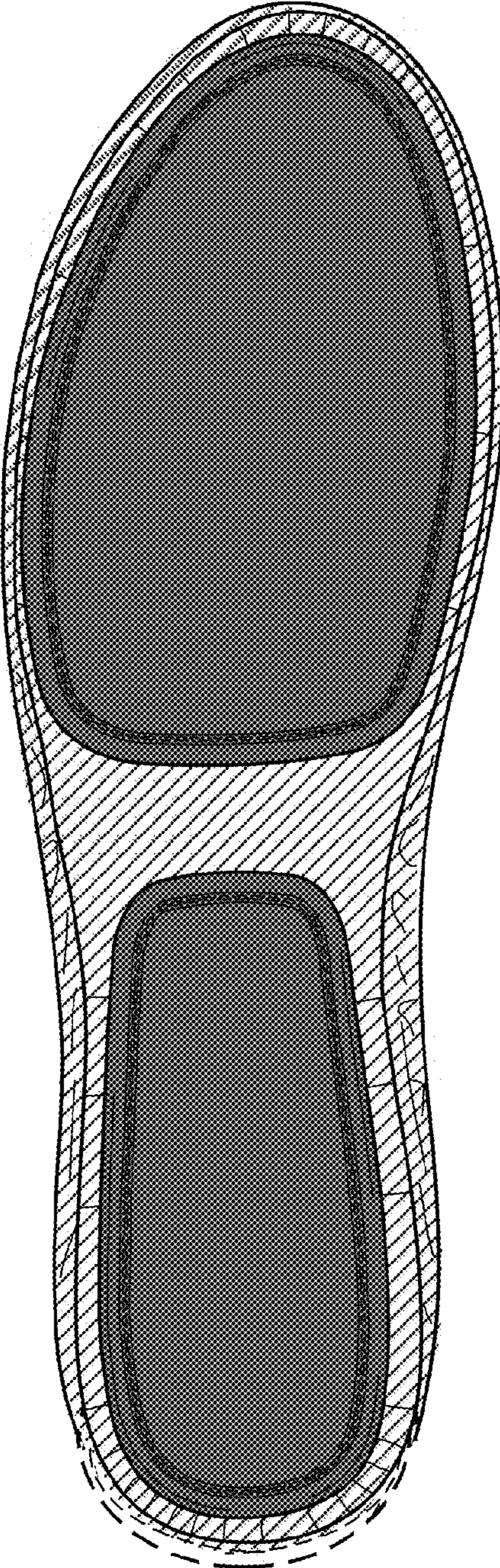

FIG. 5

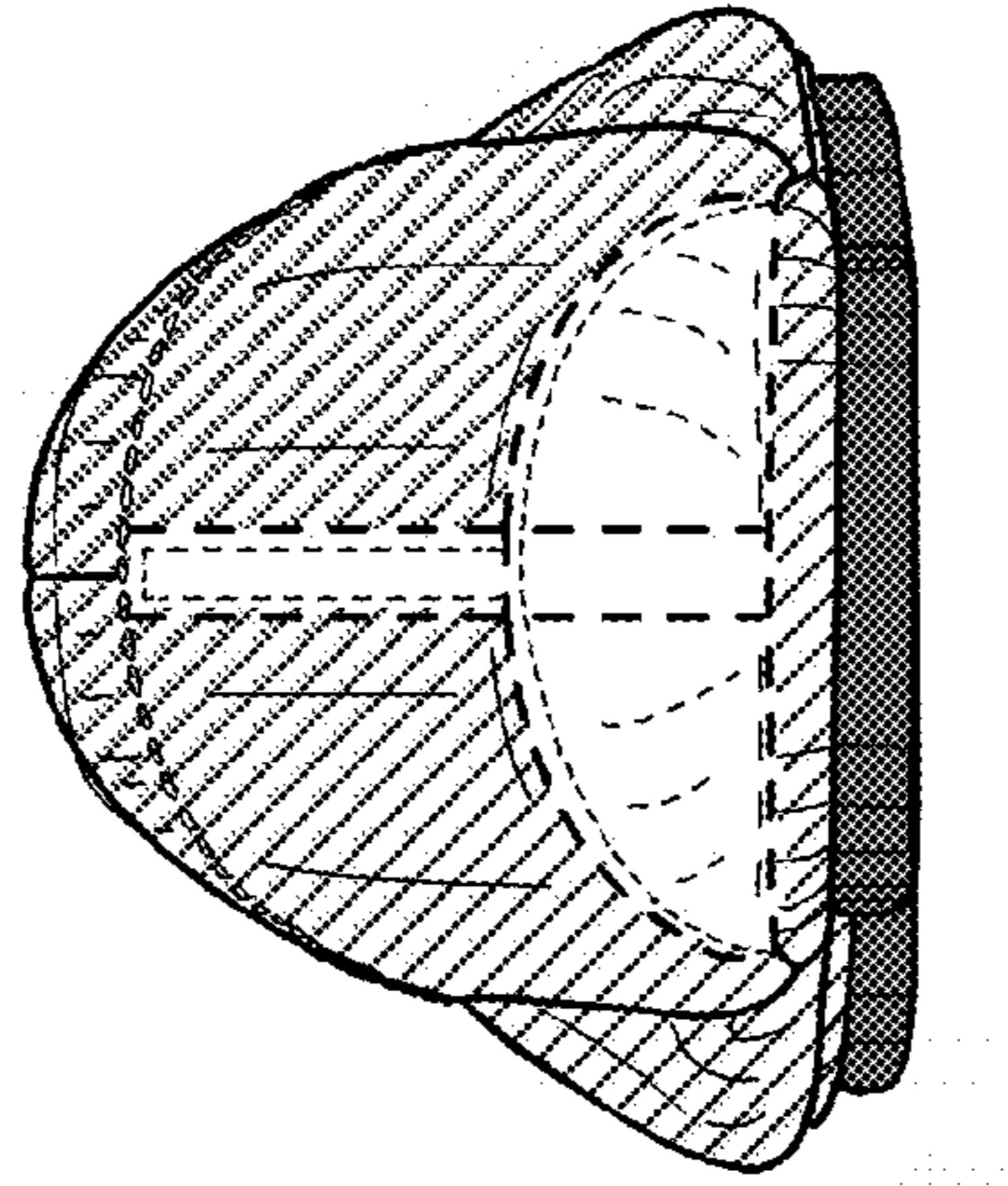

FIG. 6

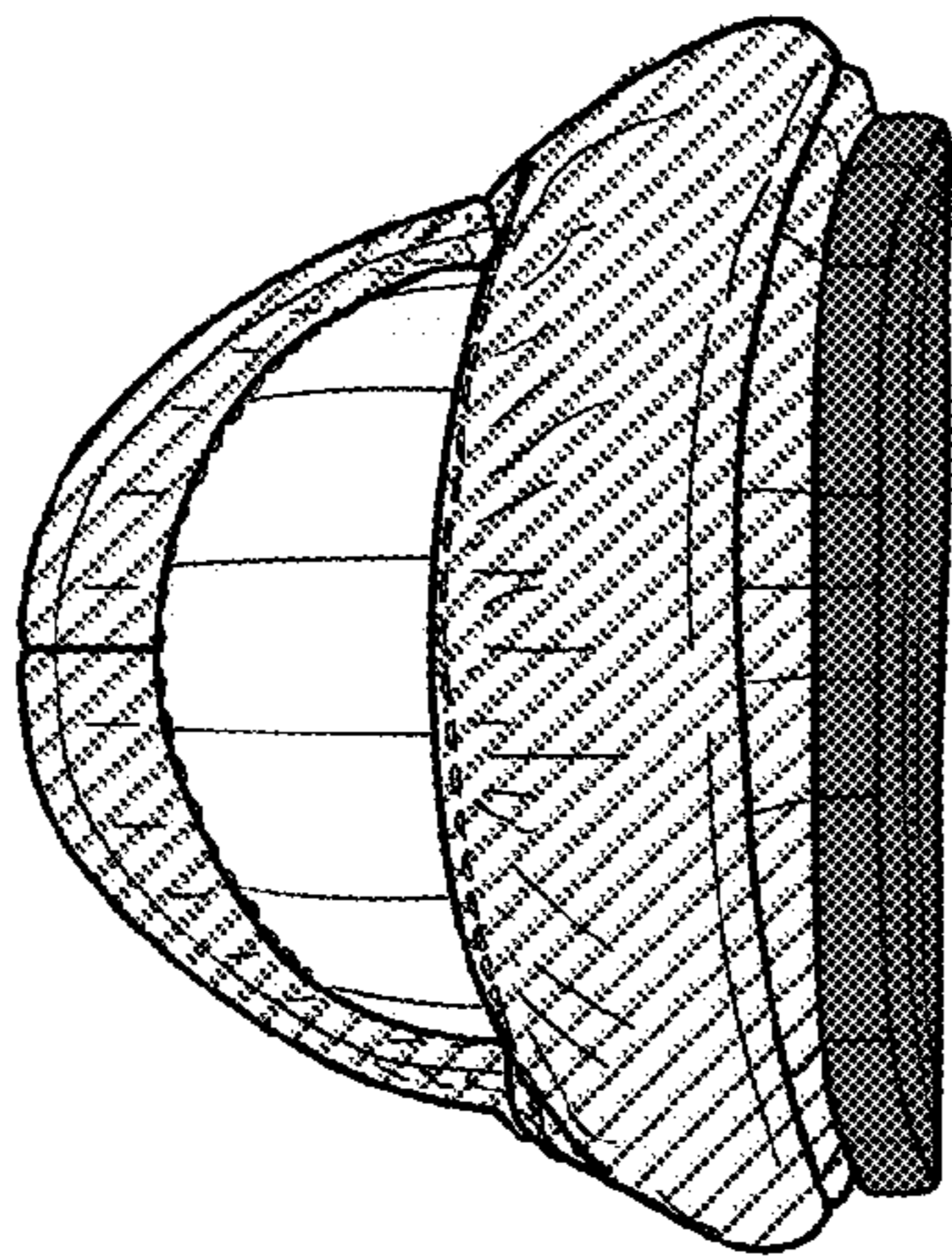

FIG. 7

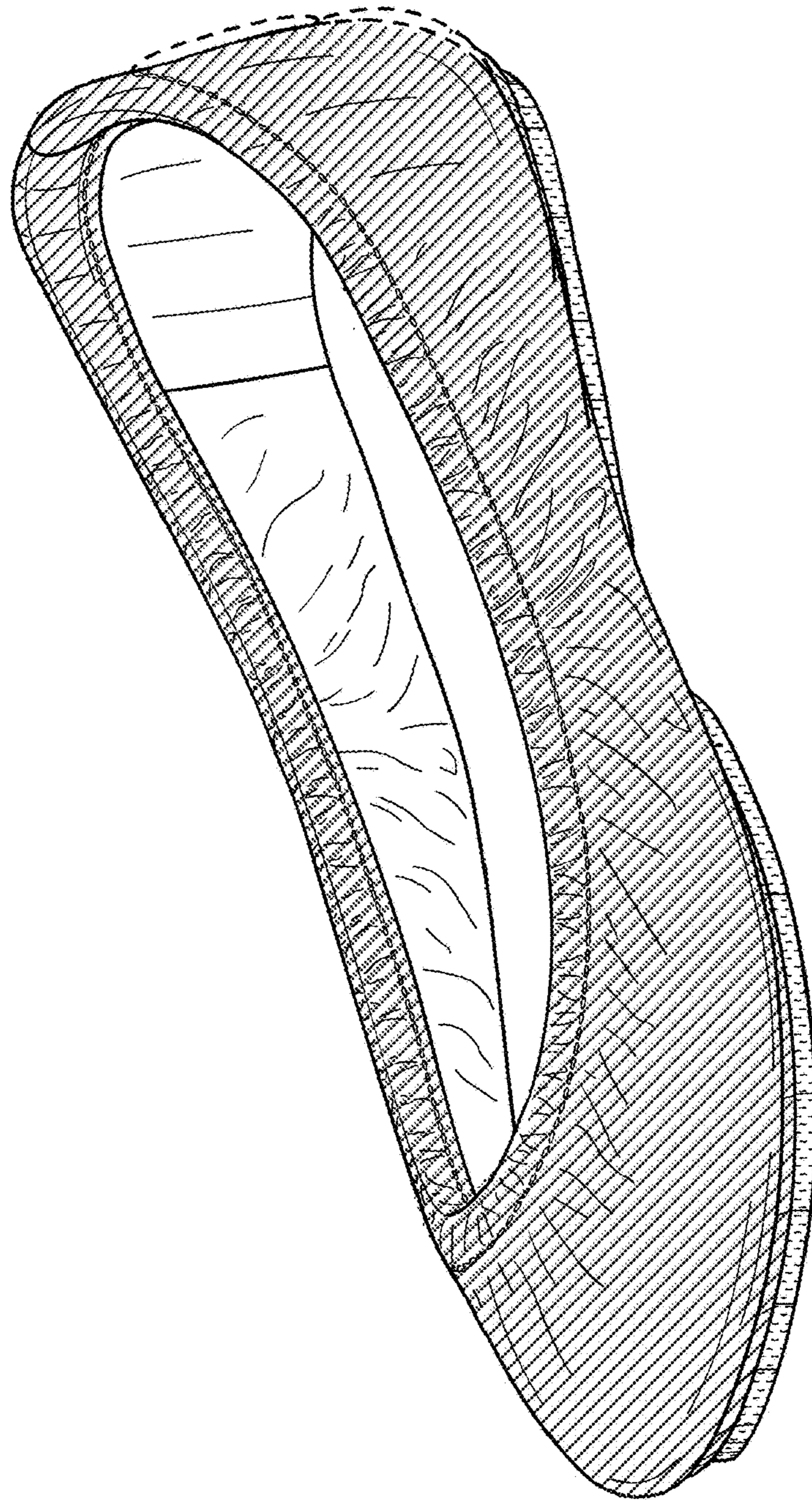

FIG. 8

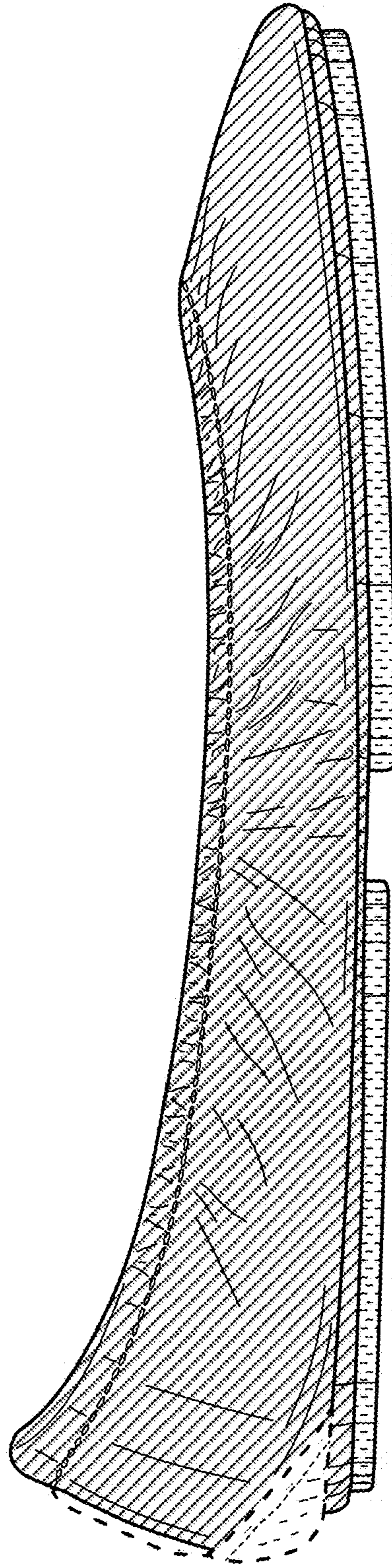

FIG. 9

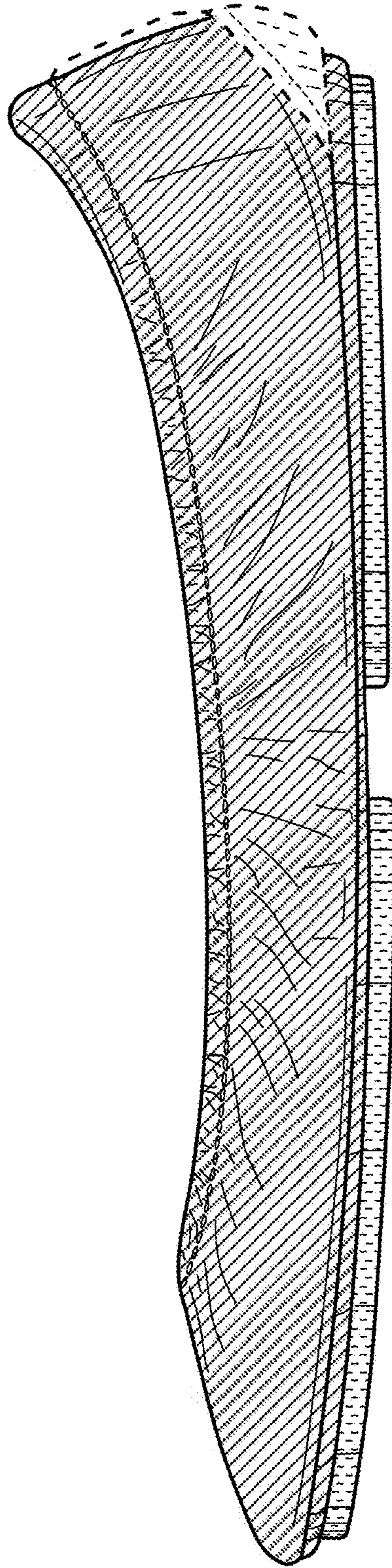

FIG. 10

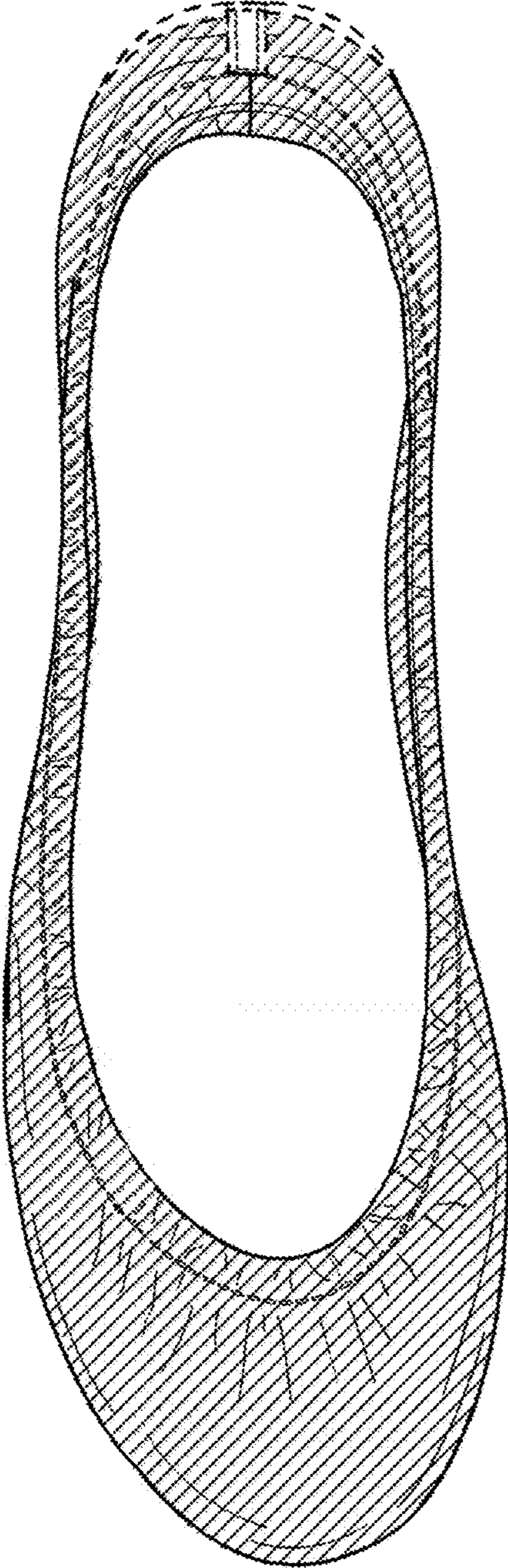

FIG. 11

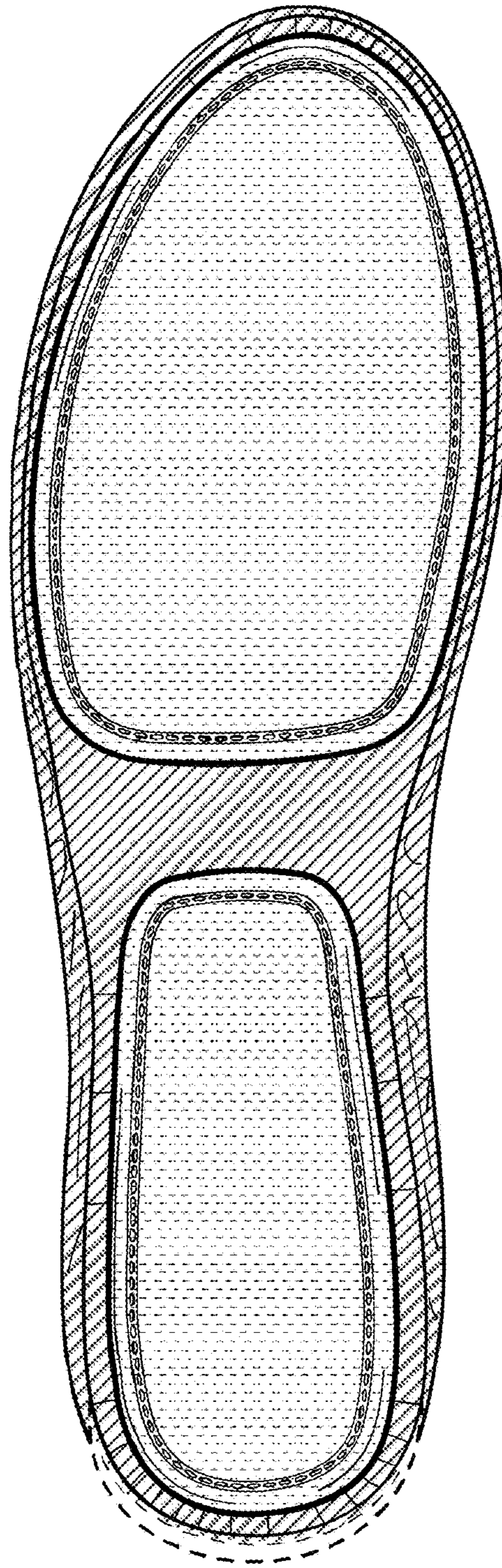

FIG. 12

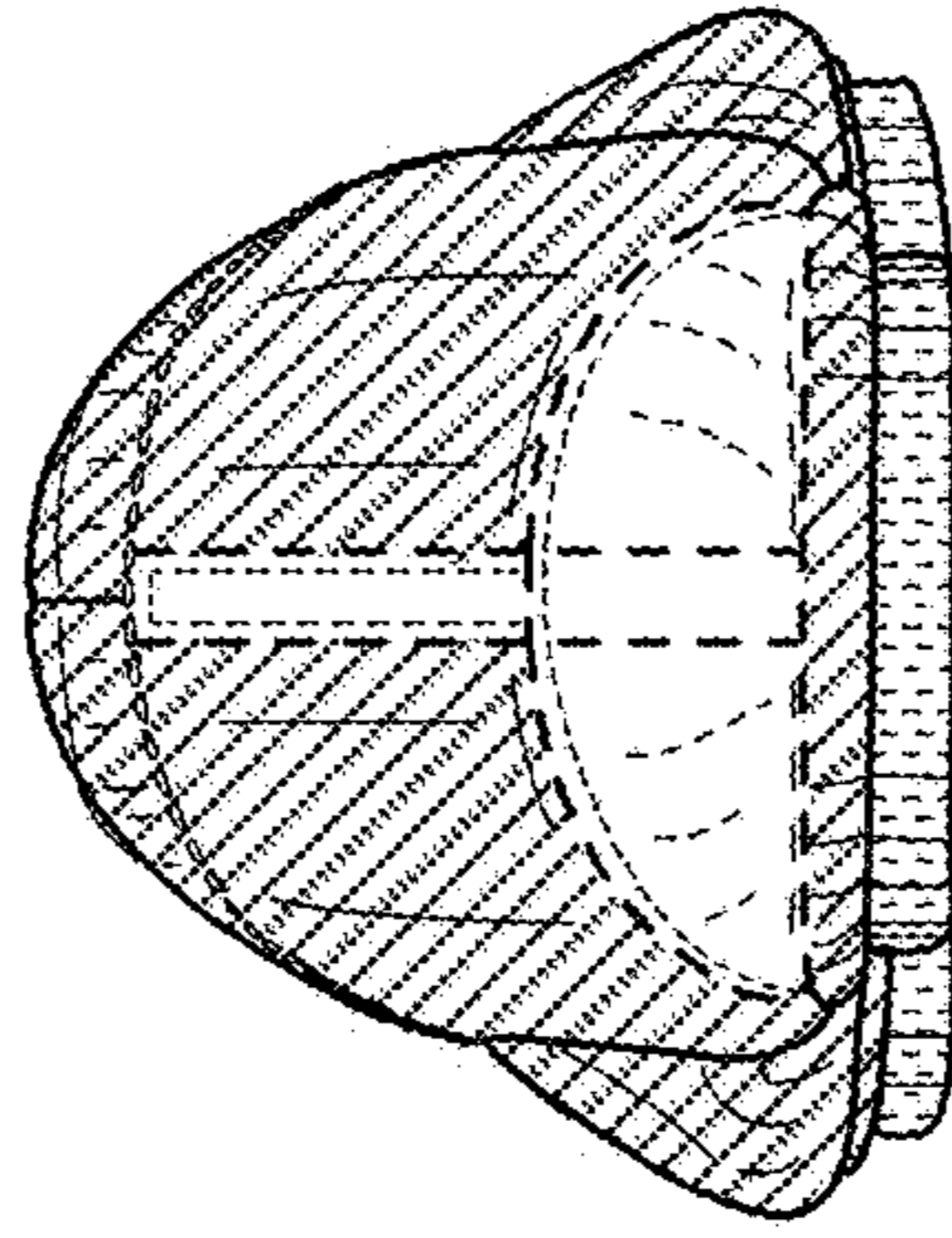

FIG. 14

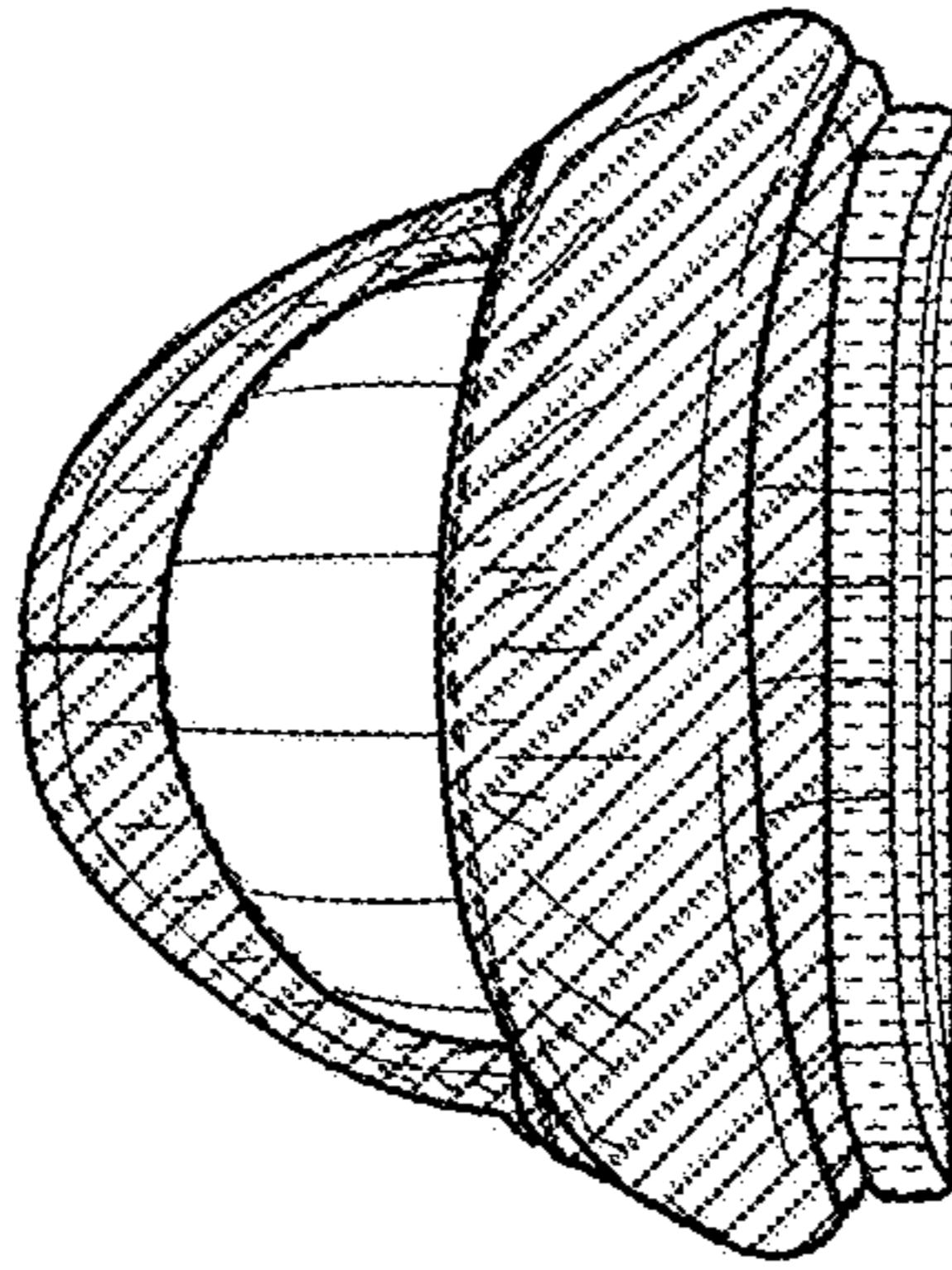

FIG. 13