



US00D853002S

(12) **United States Design Patent**
Petzl

(10) **Patent No.:** **US D853,002 S**
(45) **Date of Patent:** **** Jul. 2, 2019**

(54) **HEADLAMP**

(71) Applicant: **ZEDEL**, Crolles (FR)

(72) Inventor: **Paul Petzl**, Barraux (FR)

(73) Assignee: **ZEDEL**, Crolles (FR)

(**) Term: **15 Years**

(21) Appl. No.: **29/622,101**

(22) Filed: **Oct. 13, 2017**

(30) **Foreign Application Priority Data**

Apr. 13, 2017 (EM) 003855253-0002

(51) **LOC (11) Cl.** **26-02**

(52) **U.S. Cl.**
USPC **D26/39**

(58) **Field of Classification Search**
USPC D26/37-51

CPC F21L 2003/00; F21L 4/00; F21L 4/005;
F21L 4/02; F21L 4/025; F21L 4/027;
F21L 4/04; F21L 4/08; F21L 2005/00;
F21L 7/00; F21L 11/00; F21L 13/00;
F21L 13/04; F21L 13/08; F21L 14/02;
F21L 17/00; F21L 19/00; F21L 25/00

See application file for complete search history.

(56) **References Cited**

U.S. PATENT DOCUMENTS

D566,311 S * 4/2008 Schnell D26/39
D574,986 S * 8/2008 Kumthampinij D26/60

D578,691 S * 10/2008 Lau D26/39
D672,893 S * 12/2012 Inskeep D26/39
D679,041 S * 3/2013 Petzl D26/39
D757,317 S * 5/2016 Henry D26/39
D788,337 S * 5/2017 Koshiba D26/39
D821,007 S * 6/2018 Chen D26/39
D828,596 S * 9/2018 Cao D26/39

* cited by examiner

Primary Examiner — Lakiya G Rogers

Assistant Examiner — Carissa C Fitts

(74) *Attorney, Agent, or Firm* — Oliff PLC

(57) **CLAIM**

The ornamental design for a headlamp, as shown and described.

DESCRIPTION

FIG. 1 is a front, left-side, top perspective view of the headlamp;
FIG. 2 is a front, right-side, top perspective view thereof;
FIG. 3 is a front elevational view thereof;
FIG. 4 is a top plan view thereof;
FIG. 5 is a right-side elevational view thereof;
FIG. 6 is a left-side elevational view thereof;
FIG. 7 is a rear elevational view thereof; and,
FIG. 8 is a bottom plan view thereof.
The broken lines depict unclaimed parts of the headlamp, and thus form no part of the claimed design.

1 Claim, 6 Drawing Sheets

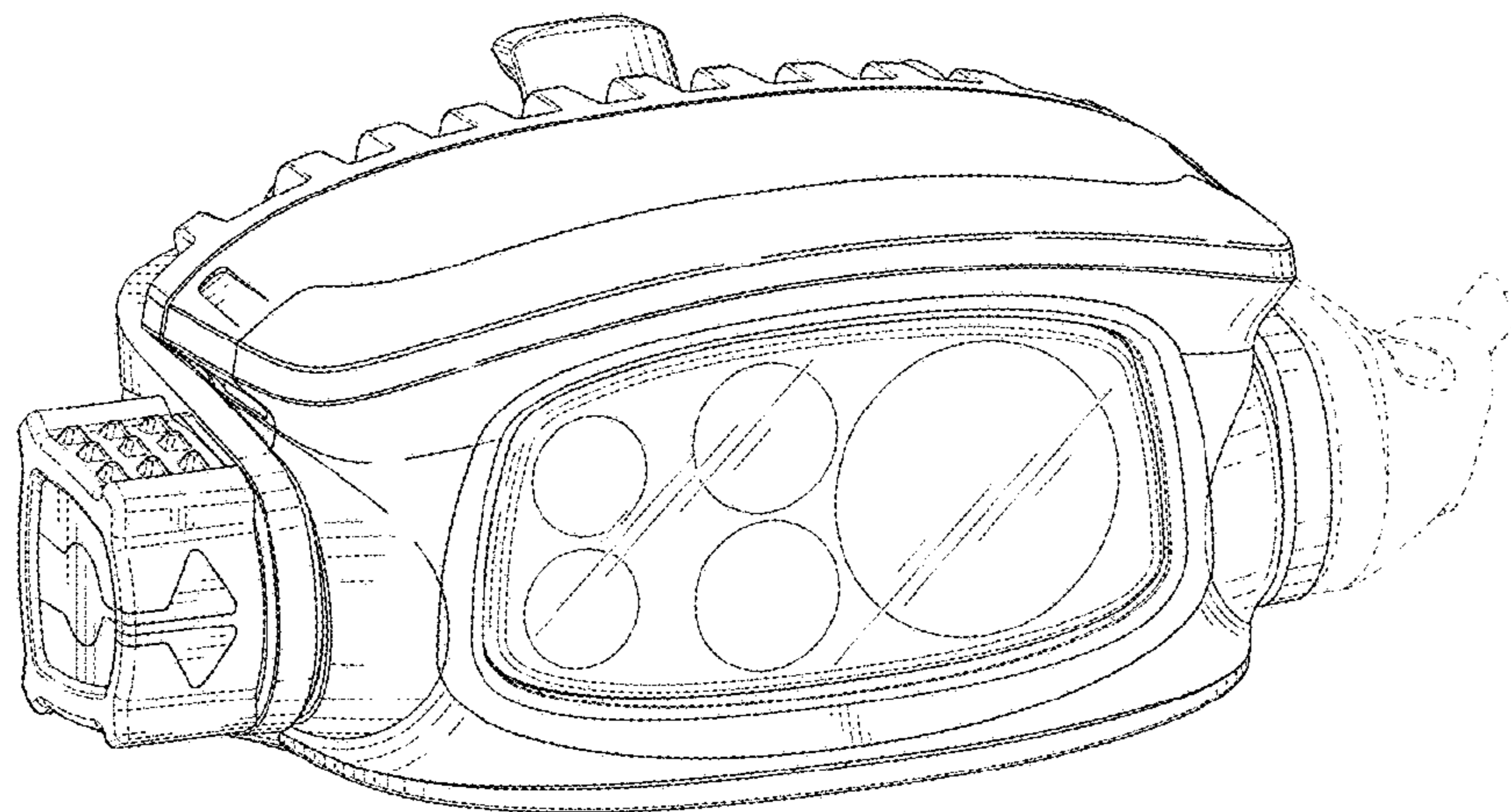

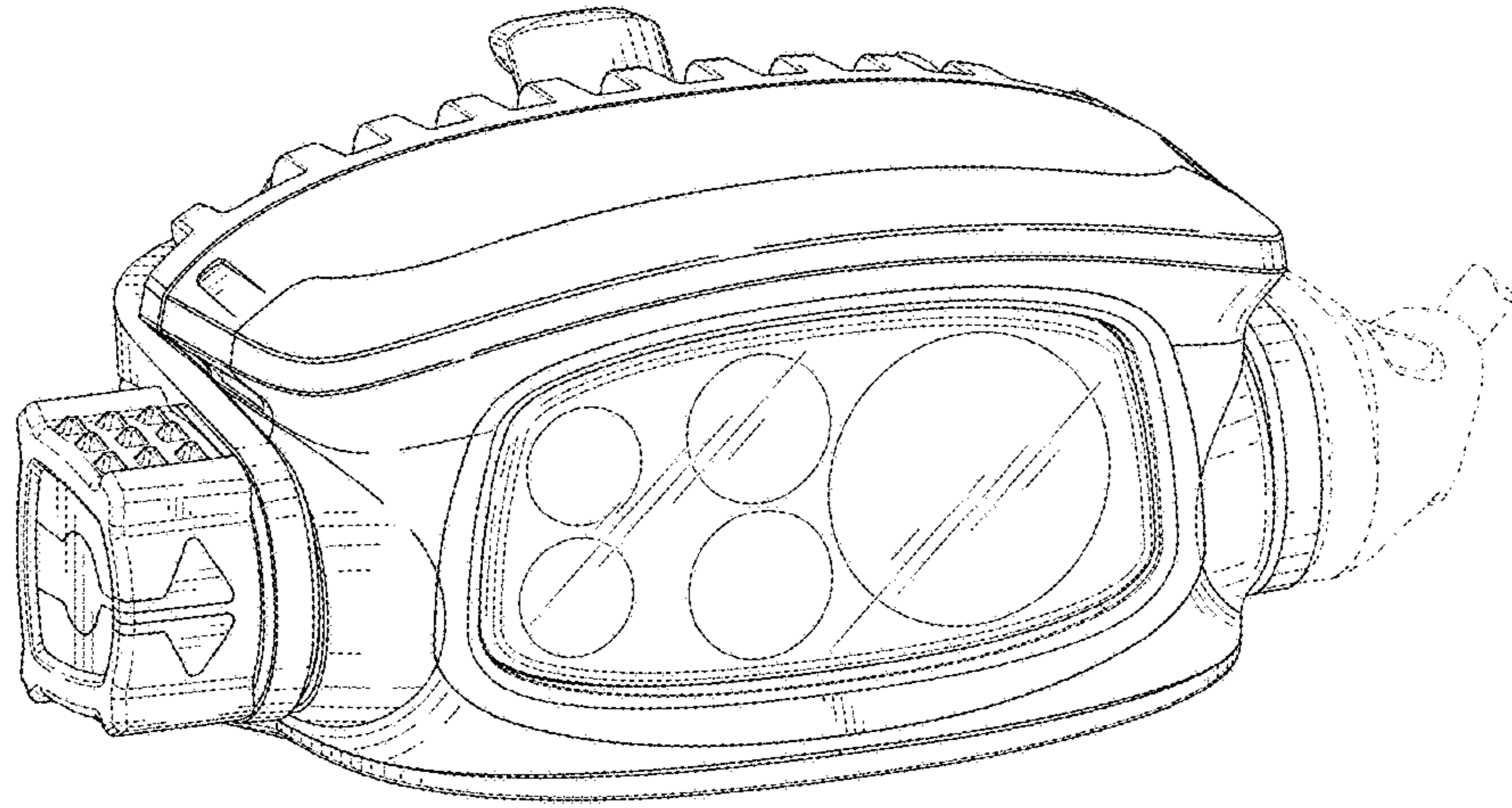

FIG. 1

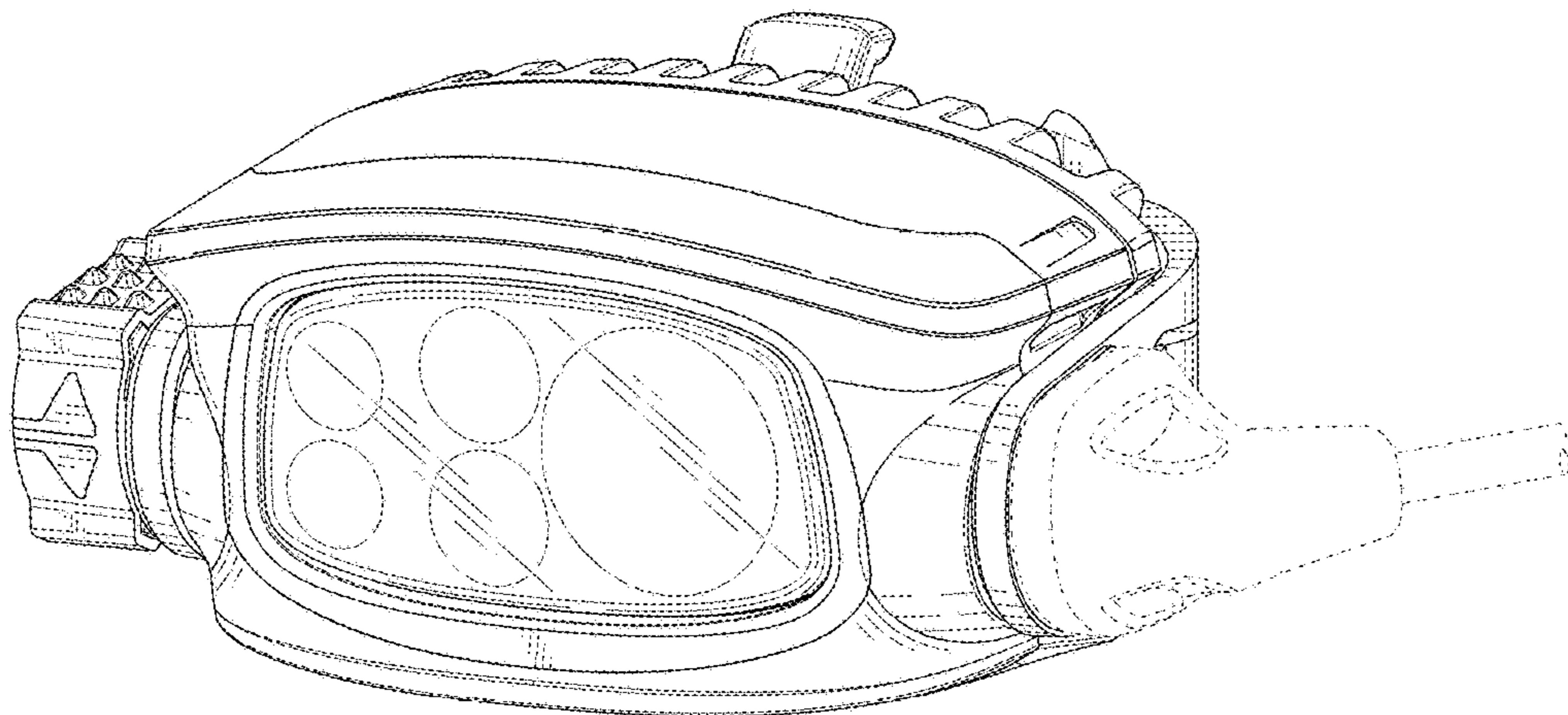

FIG. 2

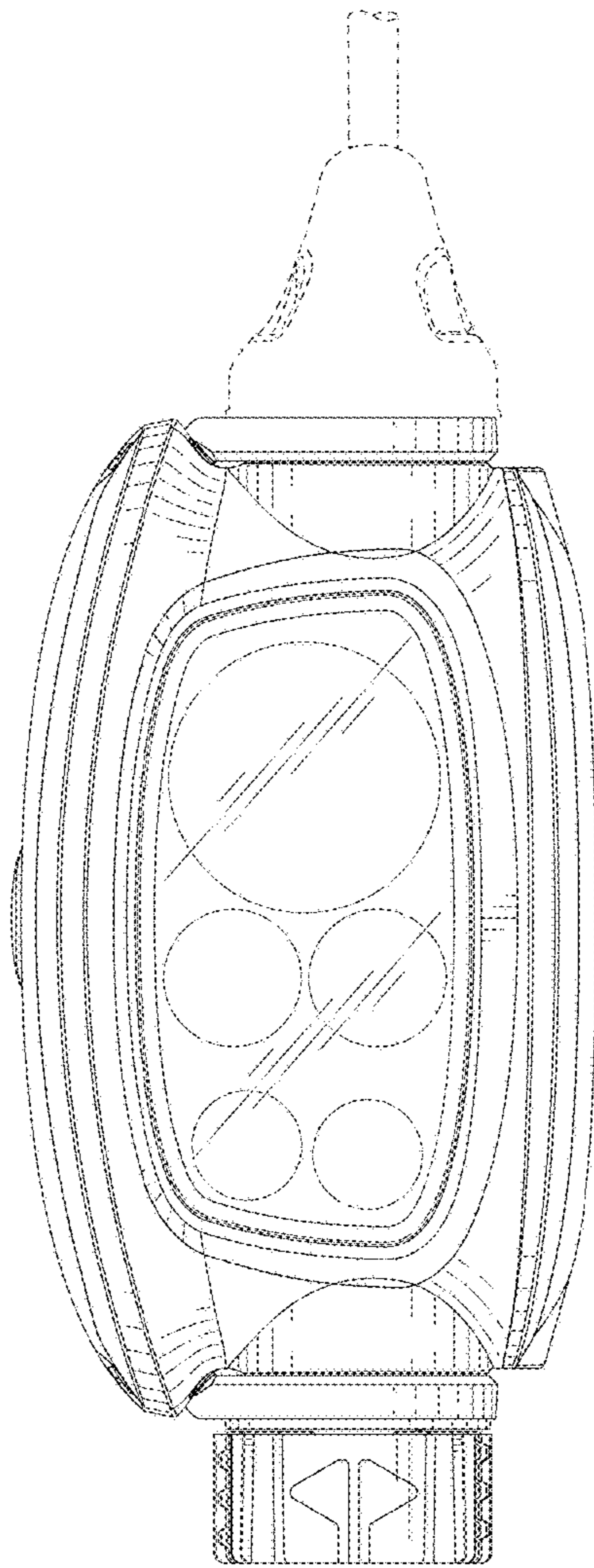

FIG. 3

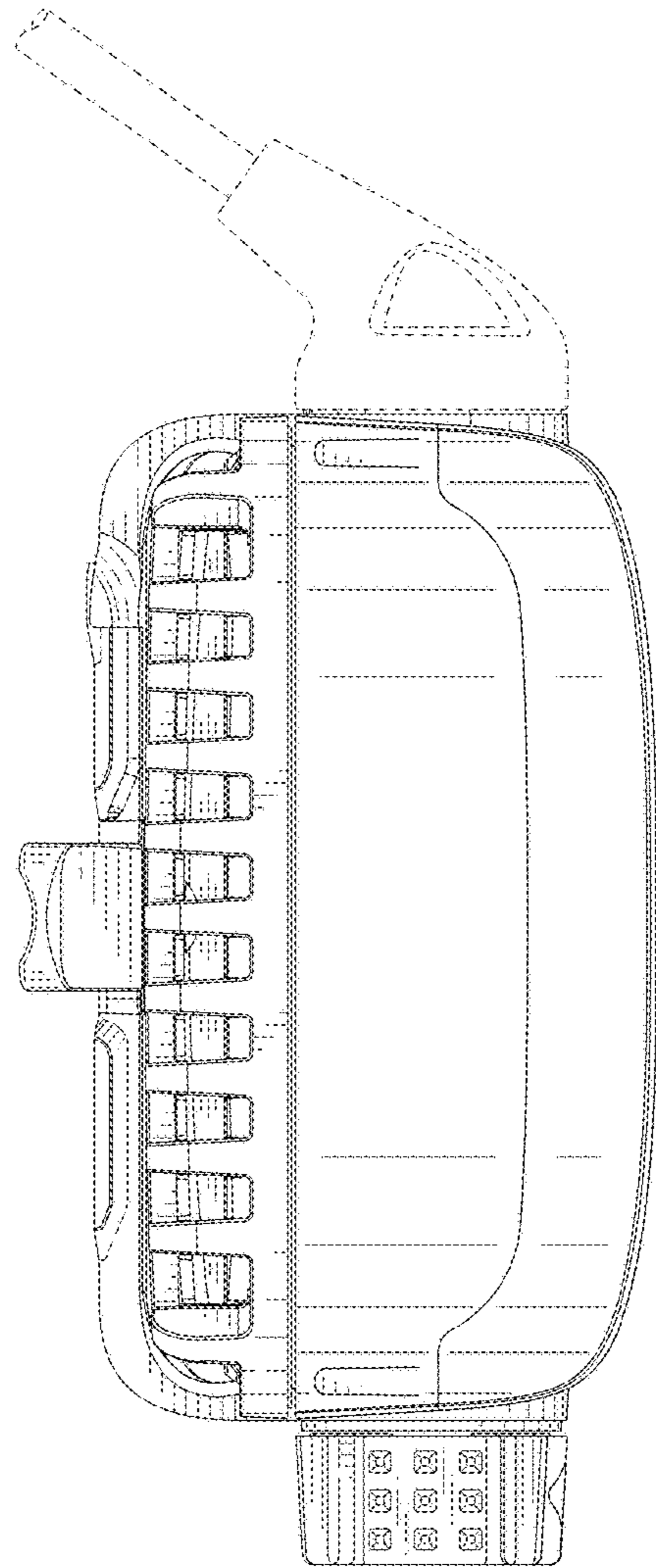

FIG. 4

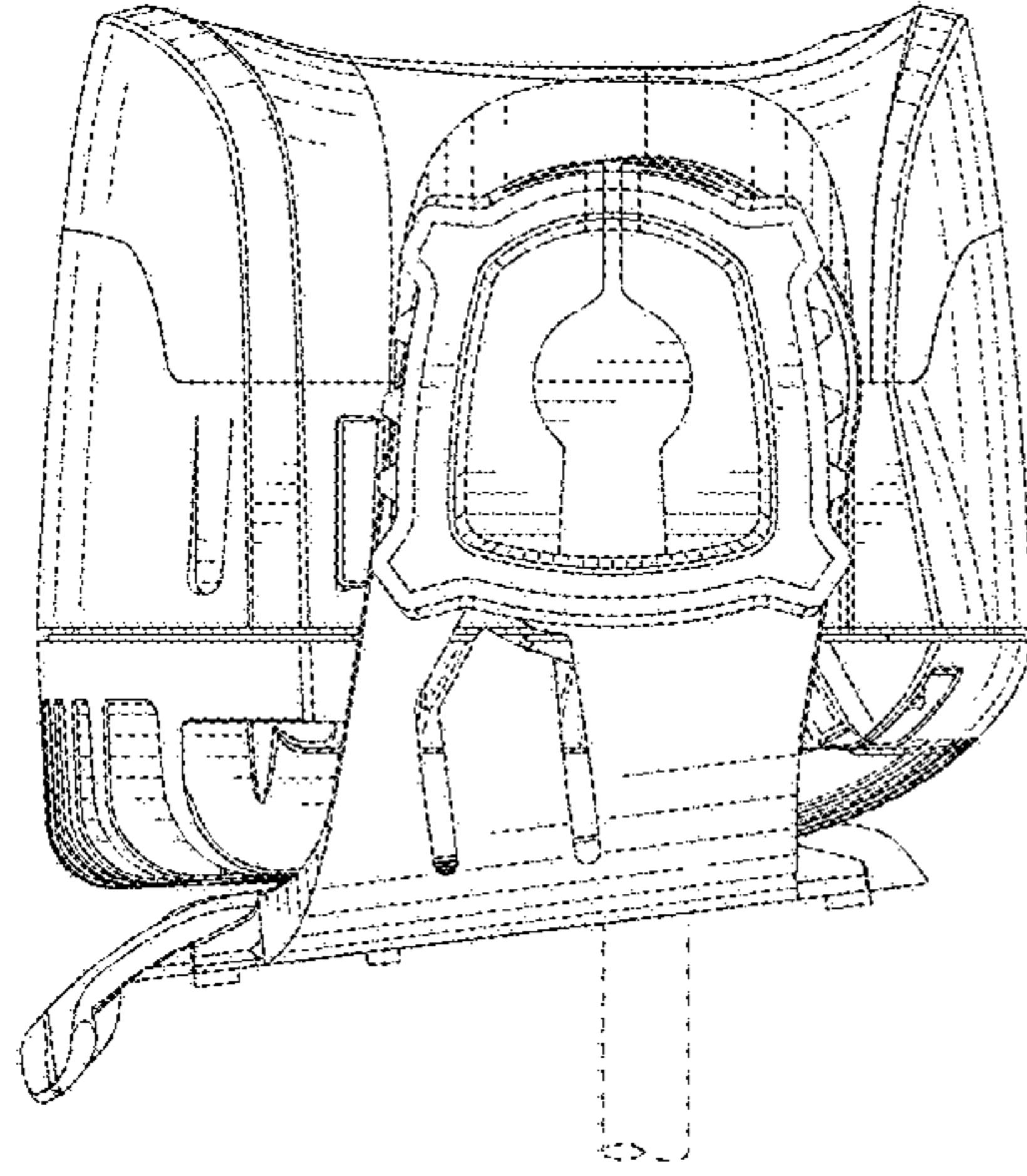

FIG. 6

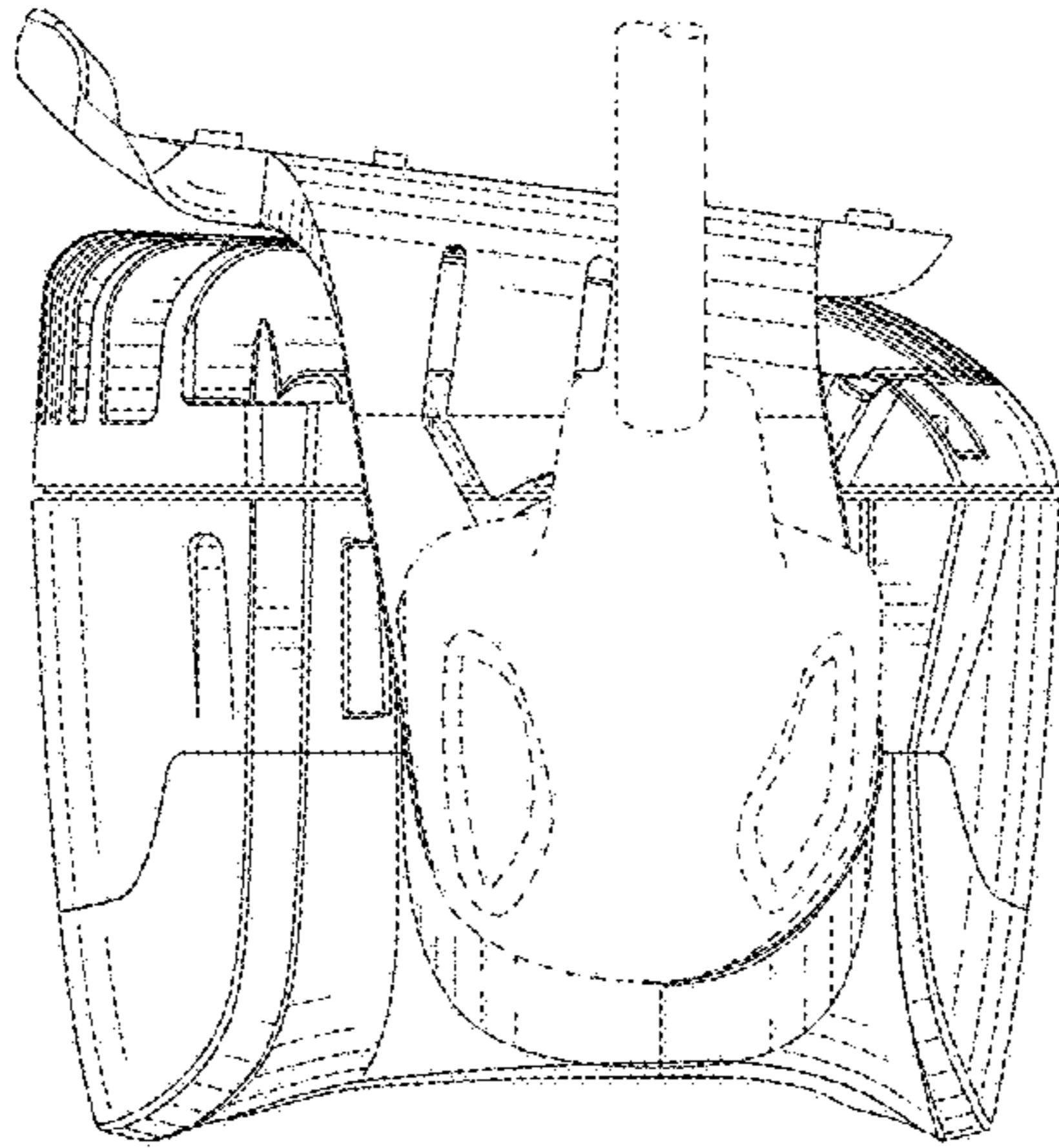

FIG. 5

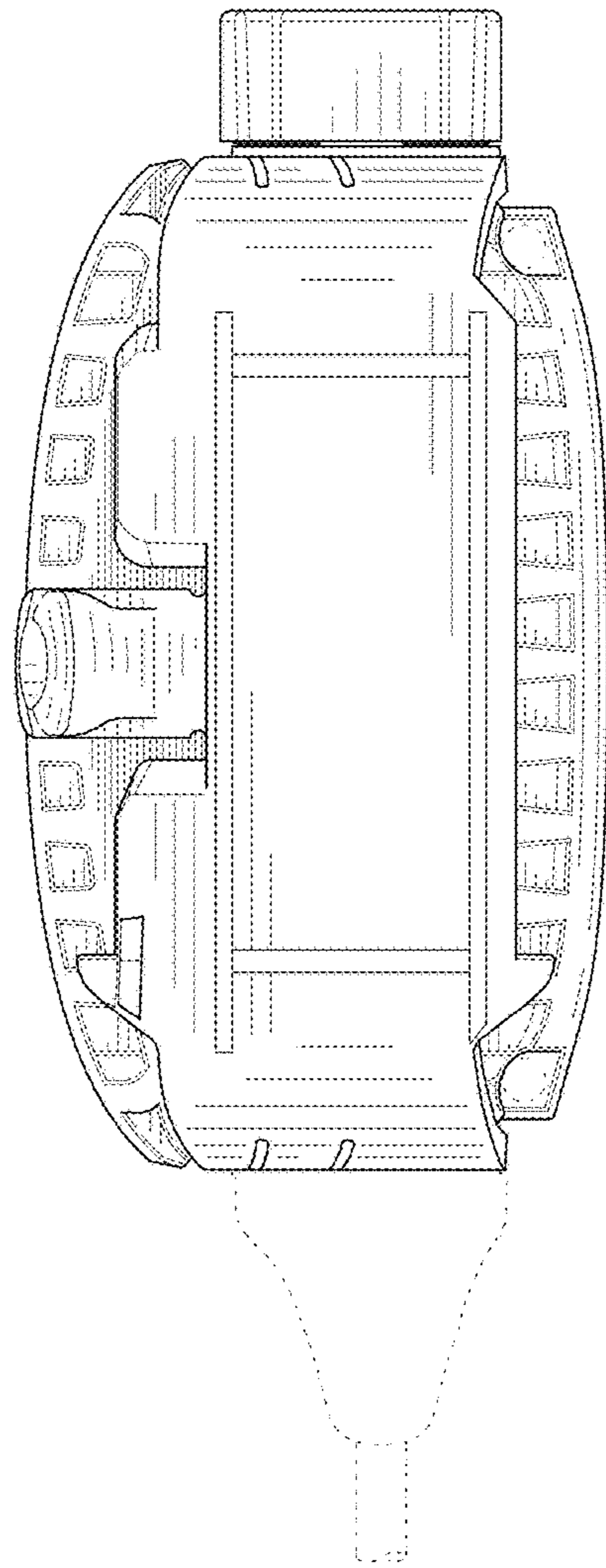

FIG. 7

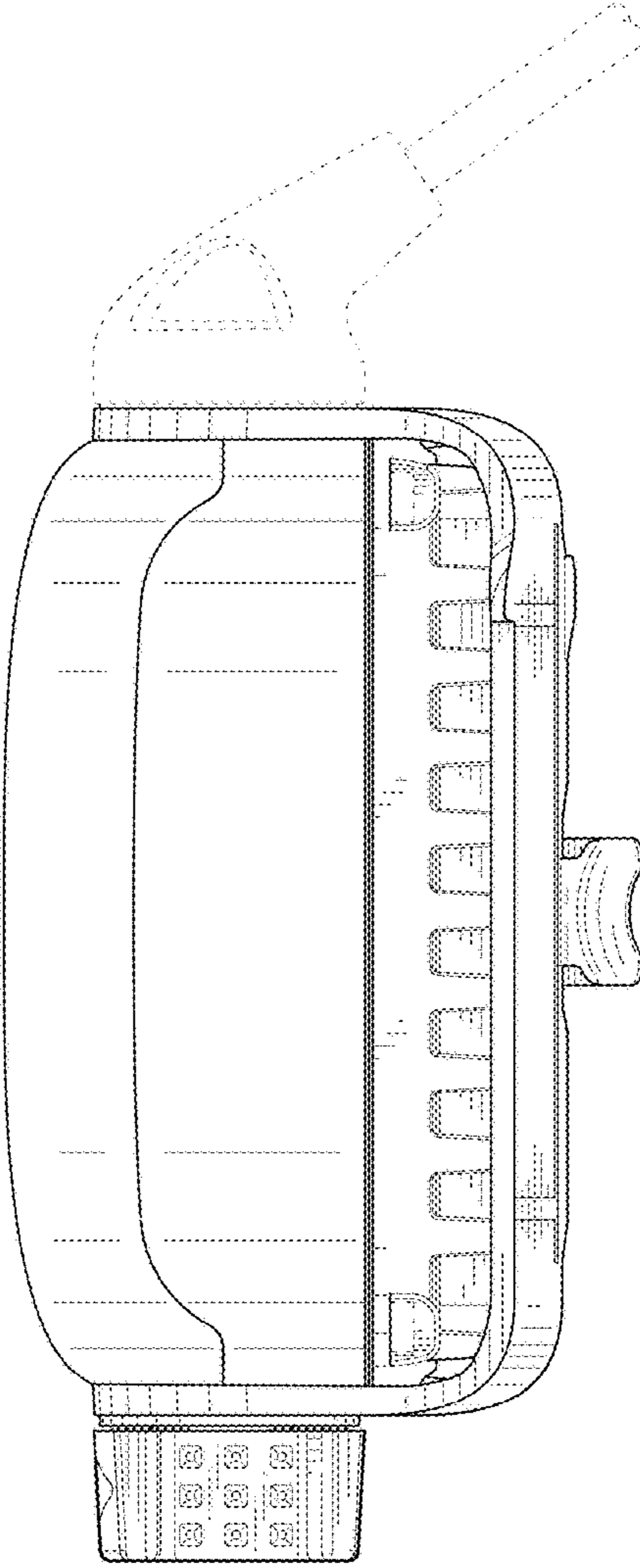

FIG. 8