



US00D852902S

(12) **United States Design Patent** (10) **Patent No.:** **US D852,902 S**
Autore (45) **Date of Patent:** **** Jul. 2, 2019**

(54) **STRETCHABLE RESILIENT TOY FIGURE**

Primary Examiner — Zenia I Bennett

(71) Applicant: **Aqua-Leisure Industries, Inc.**, Avon, MA (US)

(74) *Attorney, Agent, or Firm — Wolf, Greenfield & Sacks, P.C.*

(72) Inventor: **Gregory J. Autore**, Spring Valley, OH (US)

(57) **CLAIM**

(73) Assignee: **Aqua-Leisure Industries, Inc.**, Avon, MA (US)

The ornamental design for a stretchable resilient toy figure, as shown.

(**) Term: **15 Years**

DESCRIPTION

(21) Appl. No.: **29/641,290**

(22) Filed: **Mar. 21, 2018**

(51) **LOC (11) Cl.** **21-01**

(52) **U.S. Cl.**
USPC **D21/634**

(58) **Field of Classification Search**
USPC D21/621, 634, 635, 636, 637, 659
CPC A63H 3/00; A63H 3/04
See application file for complete search history.

FIG. 1 is a perspective view of the front side of a stretchable resilient toy figure in accordance with my new design.
FIG. 2 is a perspective view of the rear side of a stretchable resilient toy figure in accordance with my new design.
FIG. 3 is an front elevational view of the stretchable resilient toy figure of FIG. 1.
FIG. 4. is an cross-sectional view of the right arm of the stretchable resilient toy, as viewed along the line 4-4 of FIG. 3.
FIG. 5 is an elevational view of the left side of the stretchable resilient toy figure of FIG. 3.
FIG. 6 is an elevational view of the right side of the stretchable resilient toy figure of FIG. 3.
FIG. 7 is a rear elevational view of the stretchable resilient toy figure.
FIG. 8 is a bottom plan view of the stretchable resilient toy figure; and,
FIG. 9 is a top plan view of the stretchable resilient toy figure.

(56) **References Cited**

U.S. PATENT DOCUMENTS

| | | | | |
|--------------|---------|----------|-------|---------|
| D257,590 S * | 12/1980 | Jackson | | D21/637 |
| D283,150 S * | 3/1986 | Jensen | | D21/635 |
| D497,400 S * | 10/2004 | Dykstra | | D11/160 |
| D574,445 S * | 8/2008 | Auberger | | D21/621 |
| D574,898 S * | 8/2008 | Auberger | | D21/621 |
| D575,359 S * | 8/2008 | Auberger | | D21/621 |
| D780,855 S * | 3/2017 | Lambert | | D21/621 |

* cited by examiner

1 Claim, 6 Drawing Sheets

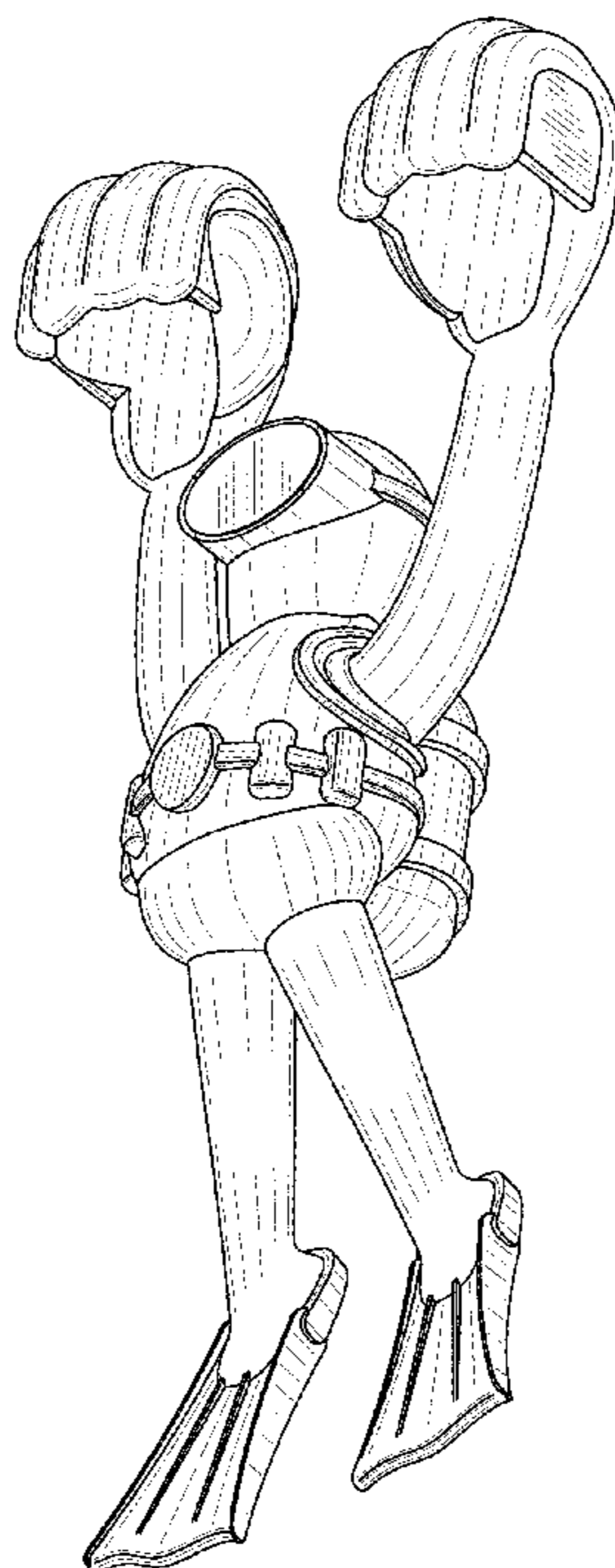

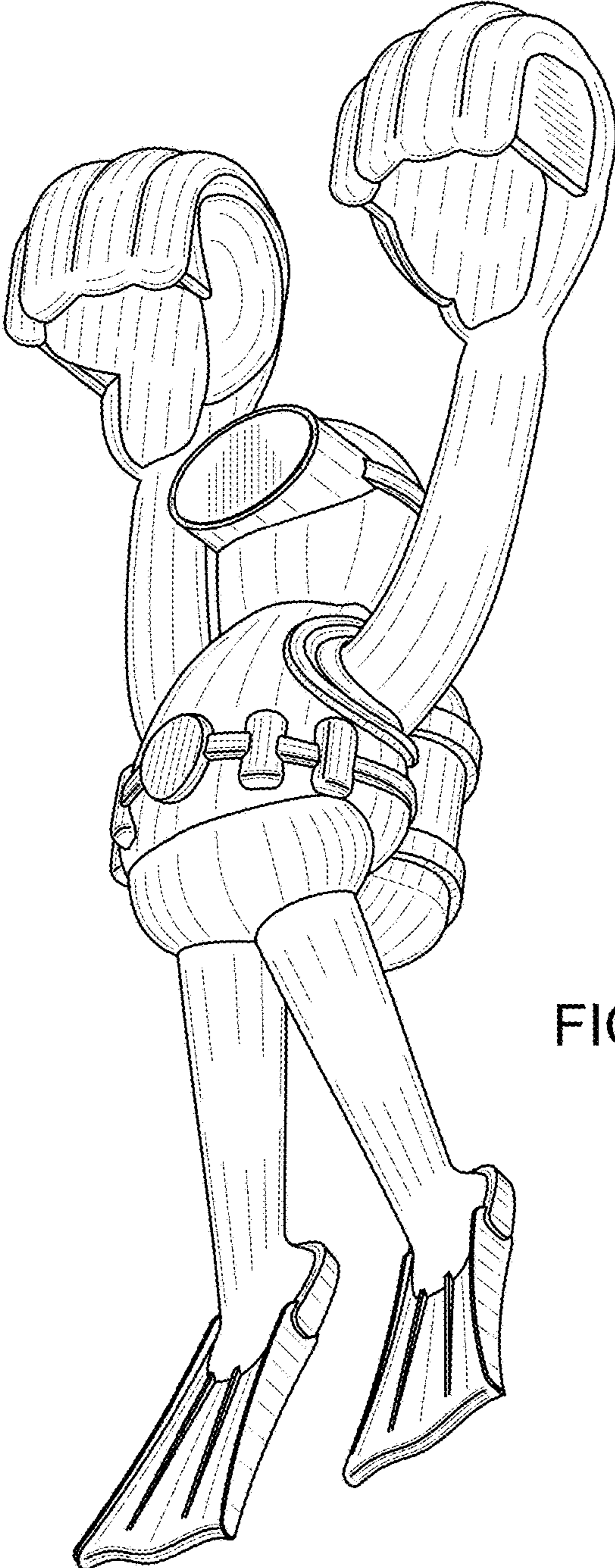

FIG. 1

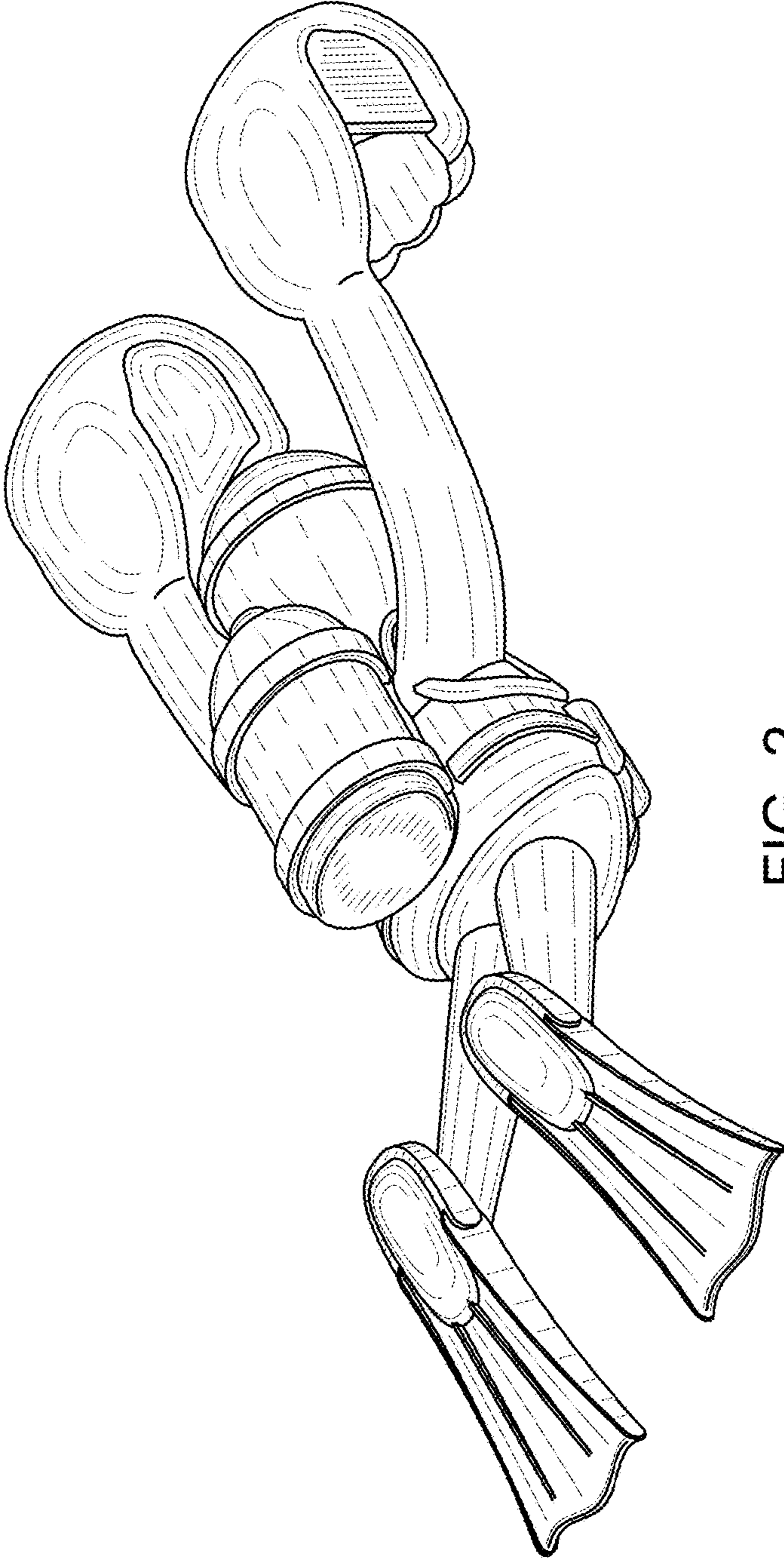

FIG. 2

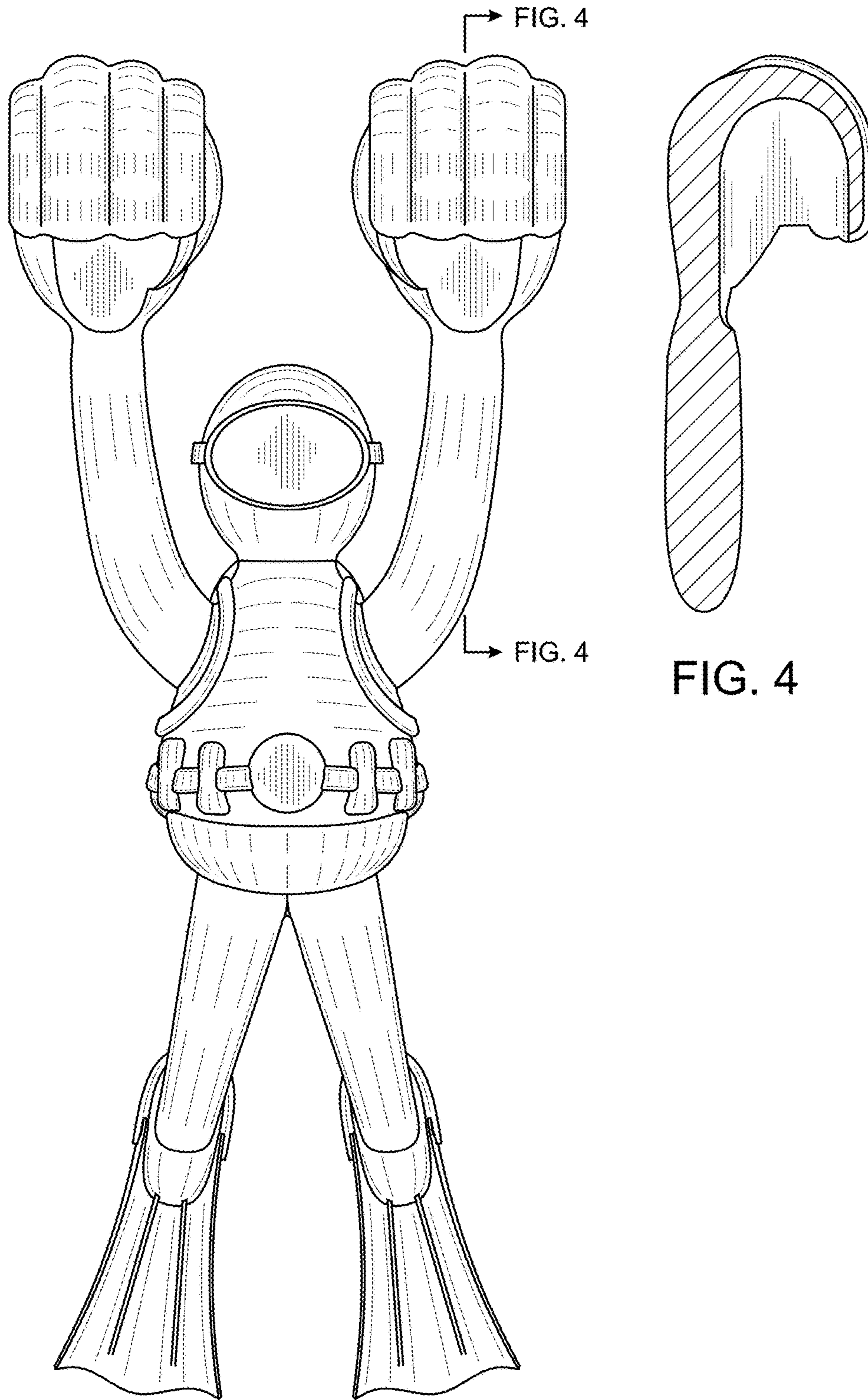

FIG. 4

FIG. 4

FIG. 4

FIG. 3

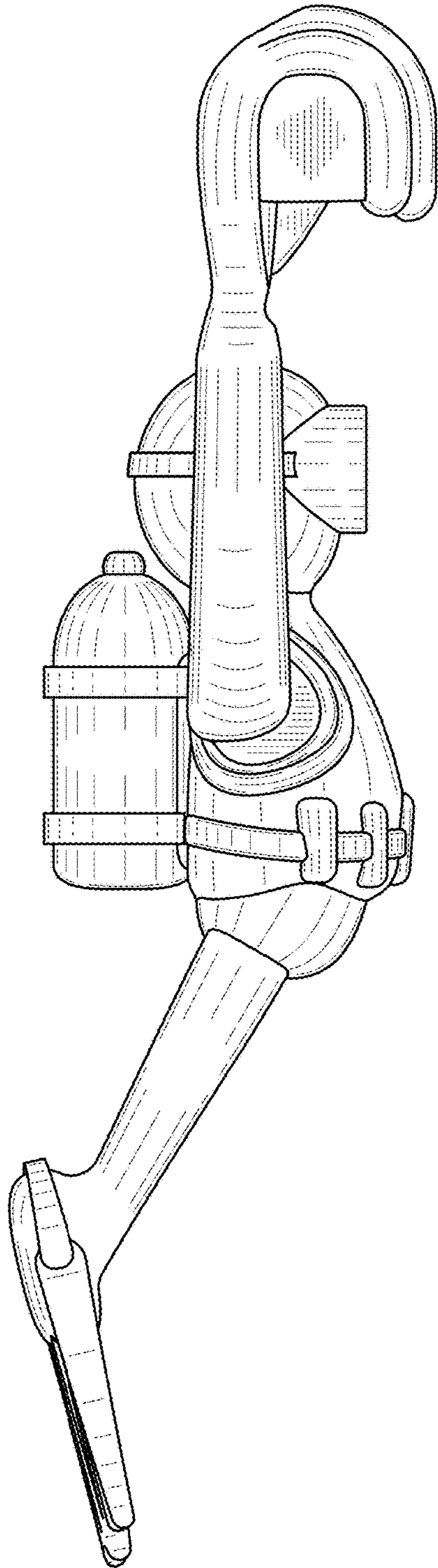

FIG. 5

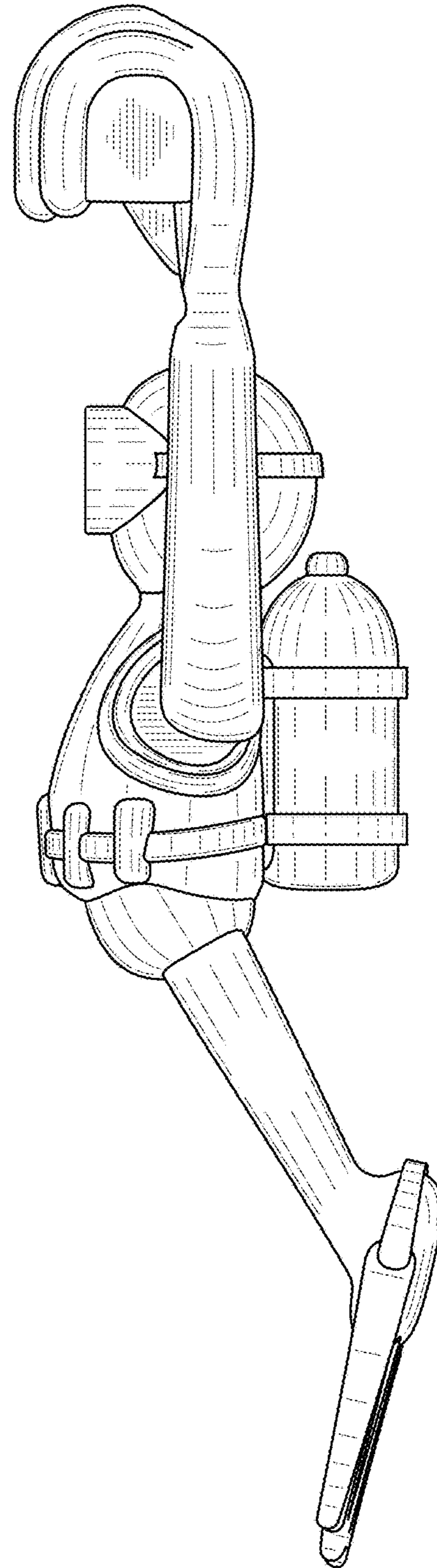

FIG. 6

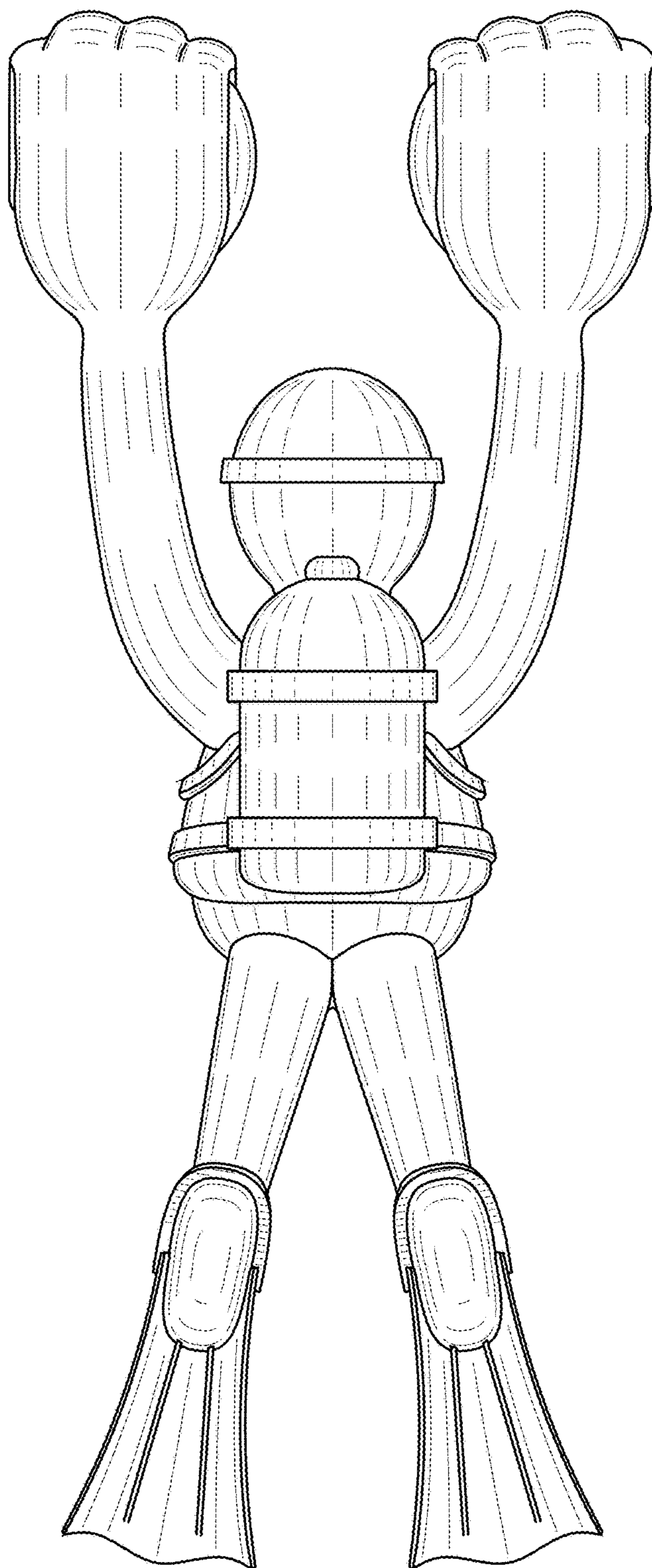

FIG. 7

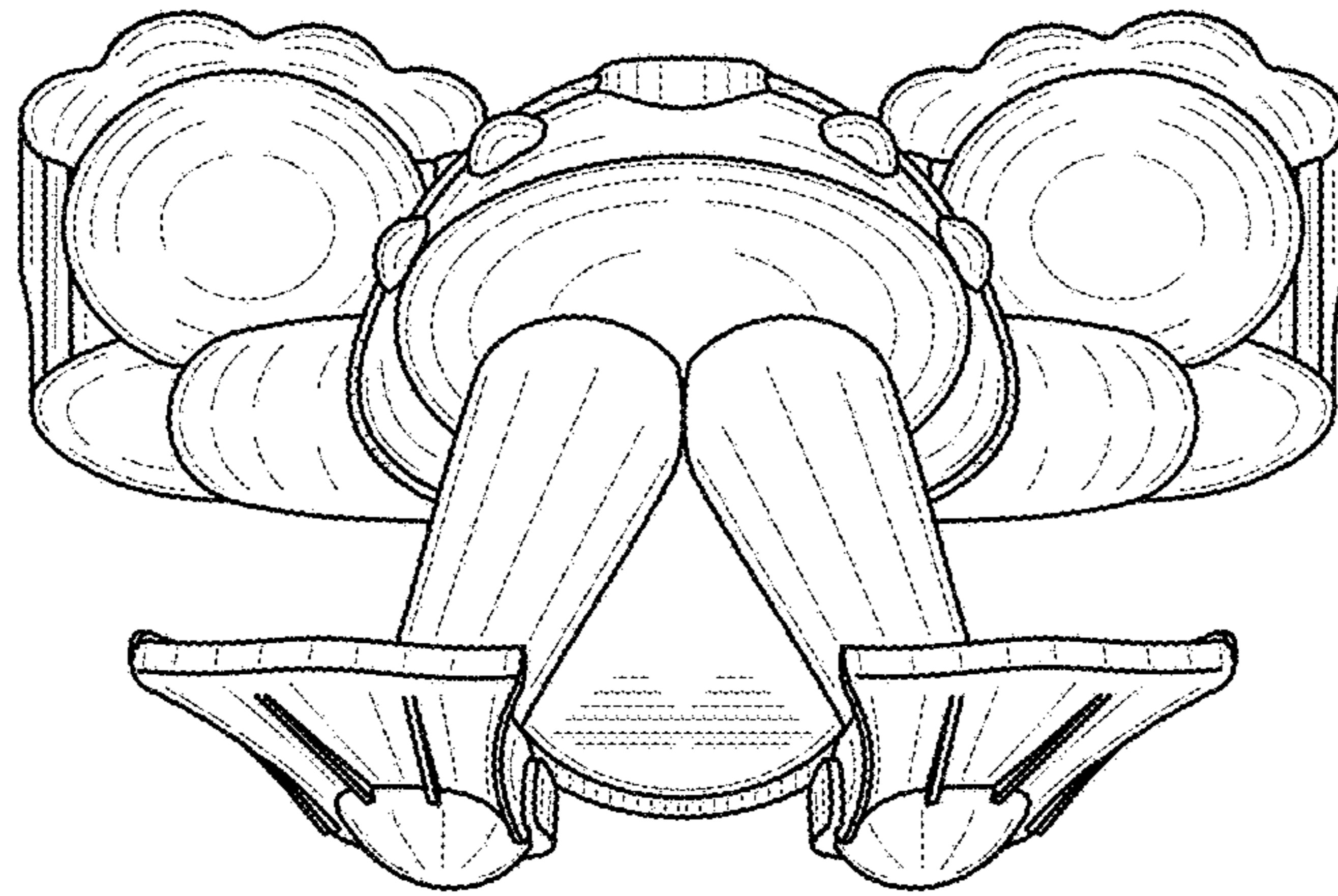

FIG. 8

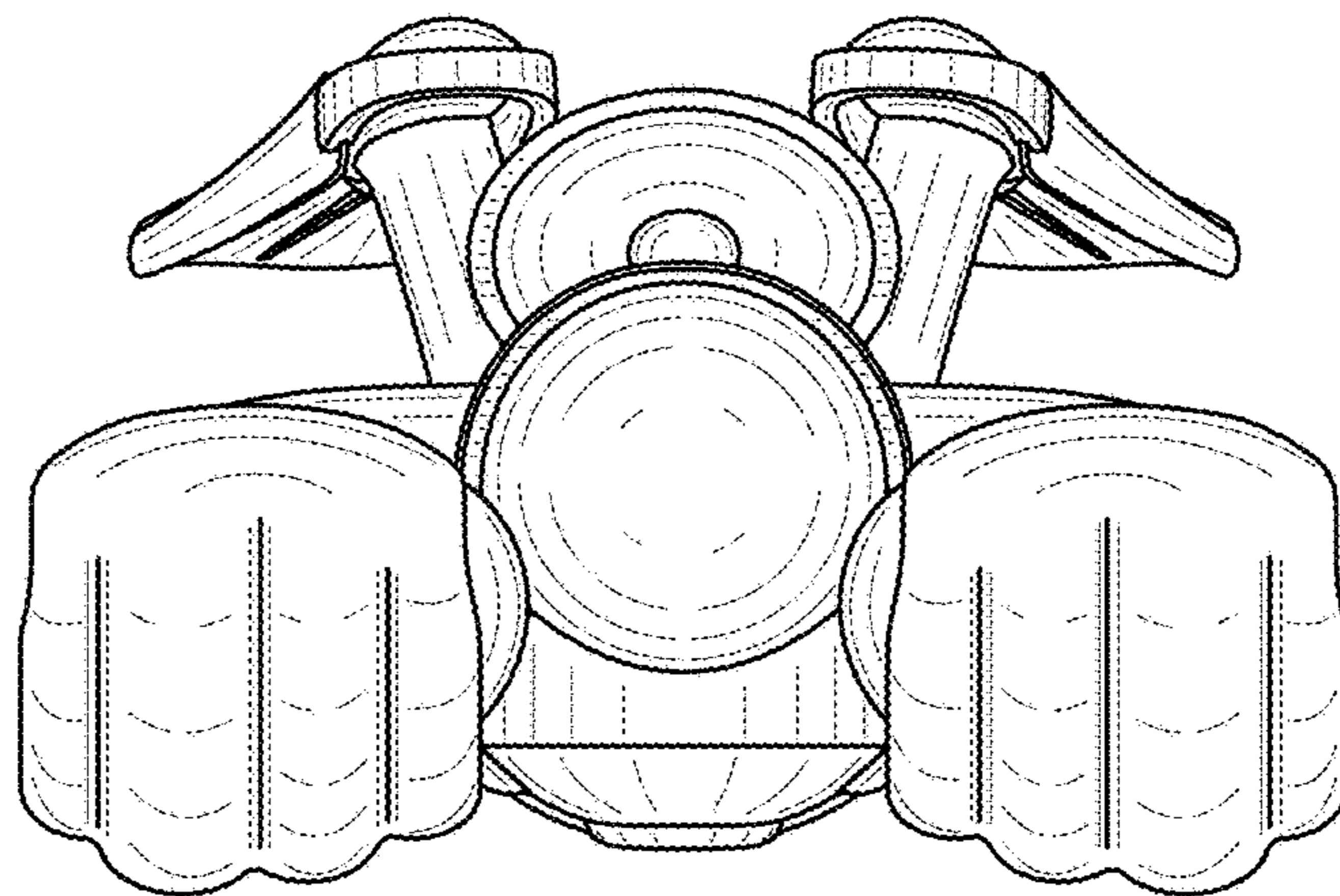

FIG. 9