



US00D852901S

(12) **United States Design Patent**
Matsuyama

(10) **Patent No.:** **US D852,901 S**
(45) **Date of Patent:** **** Jul. 2, 2019**

(54) **TOY BUS**

(71) Applicant: **EPOCH COMPANY, LTD**, Taito-ku,
Tokyo (JP)

(72) Inventor: **Daisuke Matsuyama**, Tokyo (JP)

(73) Assignee: **EPOCH COMPANY LTD**, Tokyo (JP)

(**) Term: **15 Years**

(21) Appl. No.: **29/645,147**

(22) Filed: **Apr. 24, 2018**

(30) **Foreign Application Priority Data**

Oct. 25, 2017 (JP) 2017-023697

(51) **LOC (11) Cl.** **21-01**

(52) **U.S. Cl.**
USPC **D21/552**

(58) **Field of Classification Search**
USPC D21/419, 434, 533, 548, 551, 552, 558,
D21/559; D12/1, 14, 16, 93, 96
CPC A63H 17/26; A63H 17/262; A63H 17/264;
A63H 17/266; A63H 17/36; A63H 17/38;
A63H 29/00; A63H 29/22; A63H 29/24;
A63H 30/04

See application file for complete search history.

(56) **References Cited**

U.S. PATENT DOCUMENTS

D231,665 S * 5/1974 Spiegel D21/470
D364,893 S * 12/1995 Willard D12/84

D389,658 S * 1/1998 Holt D6/632
D432,596 S * 10/2000 Rosen D21/552
D445,466 S * 7/2001 Ma D21/552
D673,624 S * 1/2013 Kasahara D21/434
D710,460 S * 8/2014 Hattori D21/552
D714,880 S * 10/2014 Hattori D21/551
D724,158 S * 3/2015 Tsuchiya D21/559
D760,325 S * 6/2016 Sano D21/552

* cited by examiner

Primary Examiner — Cynthia M. Chin

(74) *Attorney, Agent, or Firm* — Fitzgerald IP Law; John
K Fitzgerald

(57) **CLAIM**

The ornamental design for a toy bus, as shown and
described.

DESCRIPTION

FIG. 1 is a front perspective view of a toy bus showing my
new design;
FIG. 2 is a rear perspective view thereof;
FIG. 3 is a front view thereof;
FIG. 4 is a rear view thereof;
FIG. 5 is a top plan view thereof;
FIG. 6 is a left side view thereof; and
FIG. 7 is a right side view thereof; and,
FIG. 8 is a reference view of usage thereof in a state that a
roof part is detached.
The broken lines shown are included for the purpose of
illustrating portions of the article which form no part of the
claimed design.

1 Claim, 8 Drawing Sheets

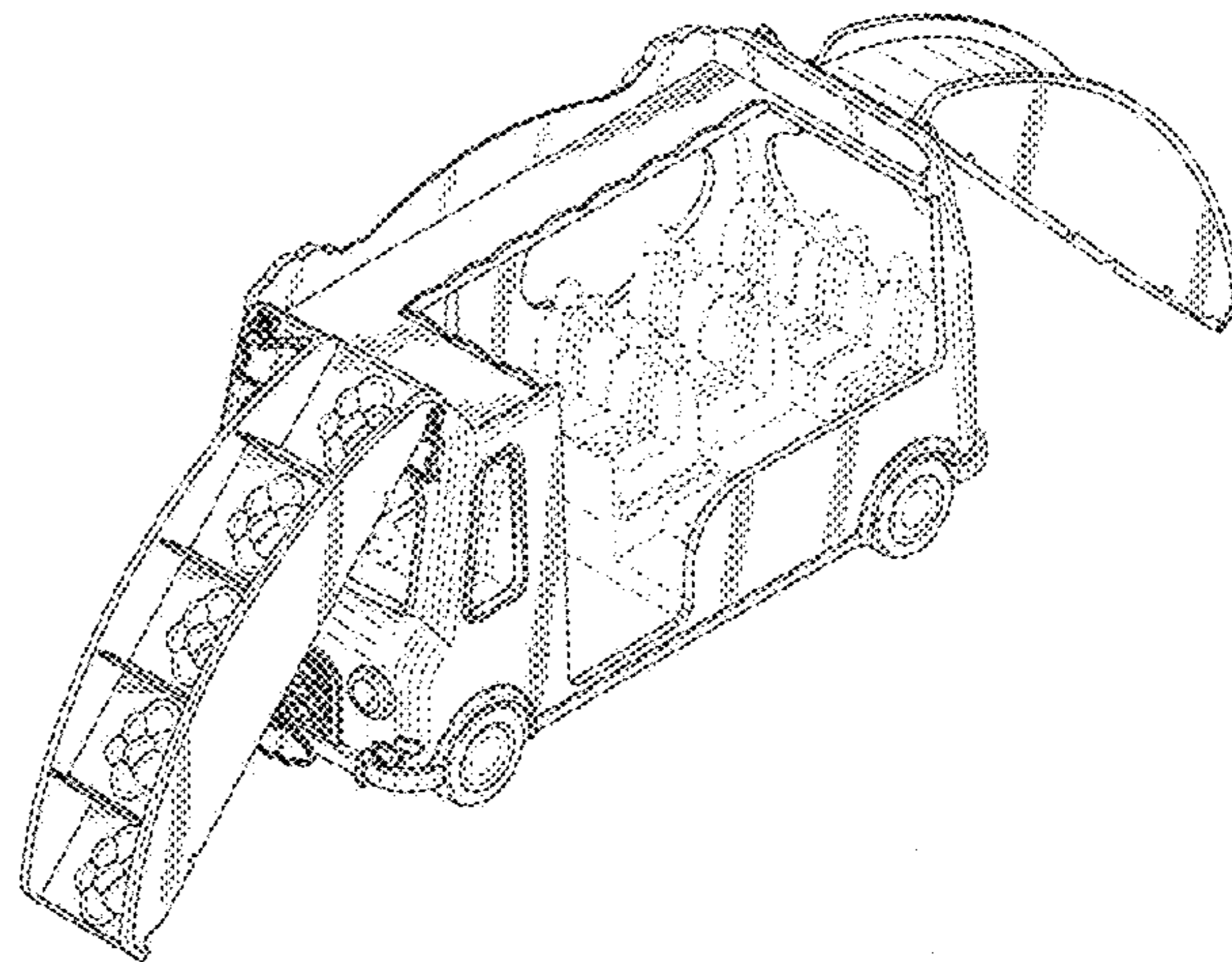
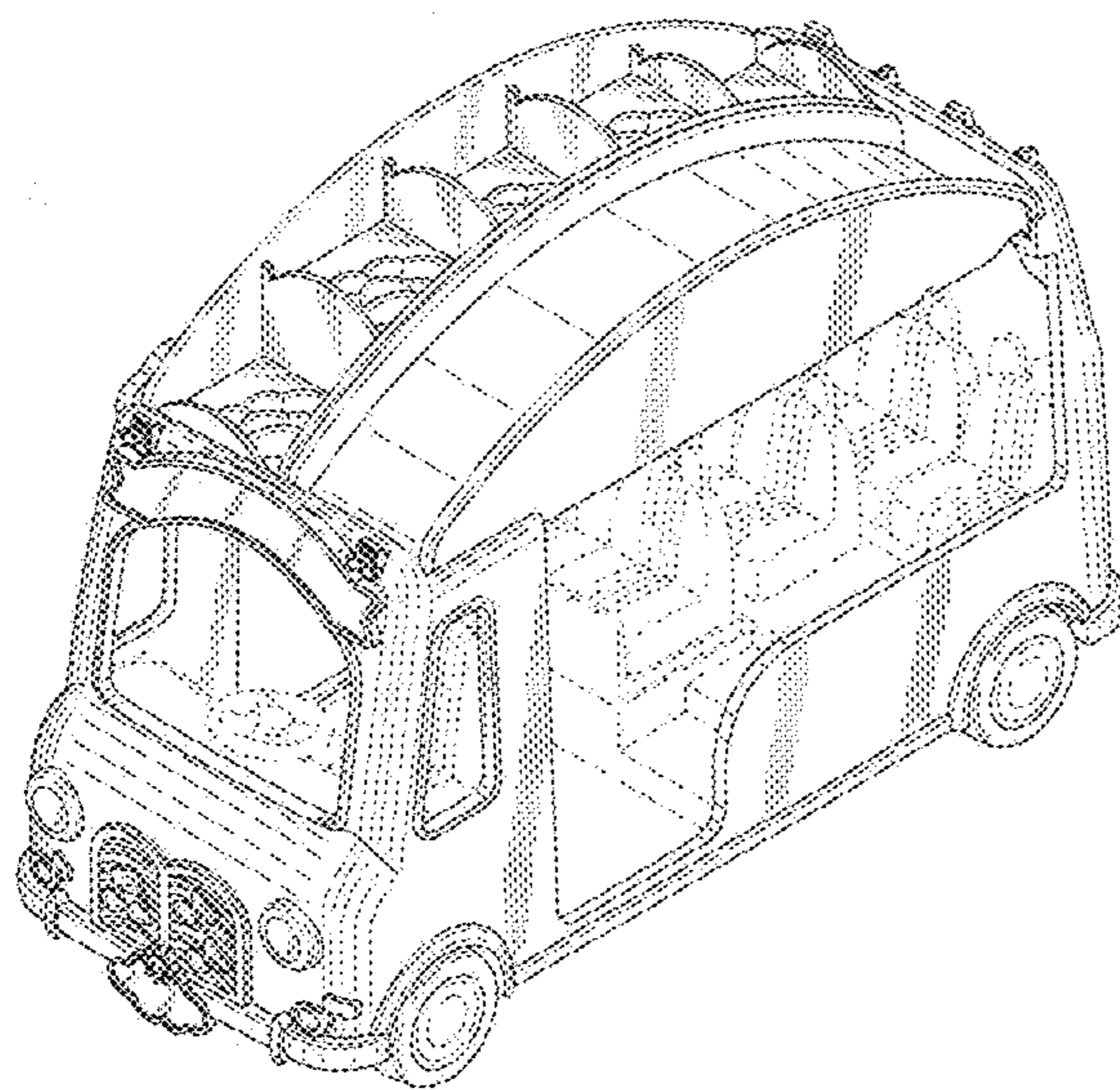

FIG. 1

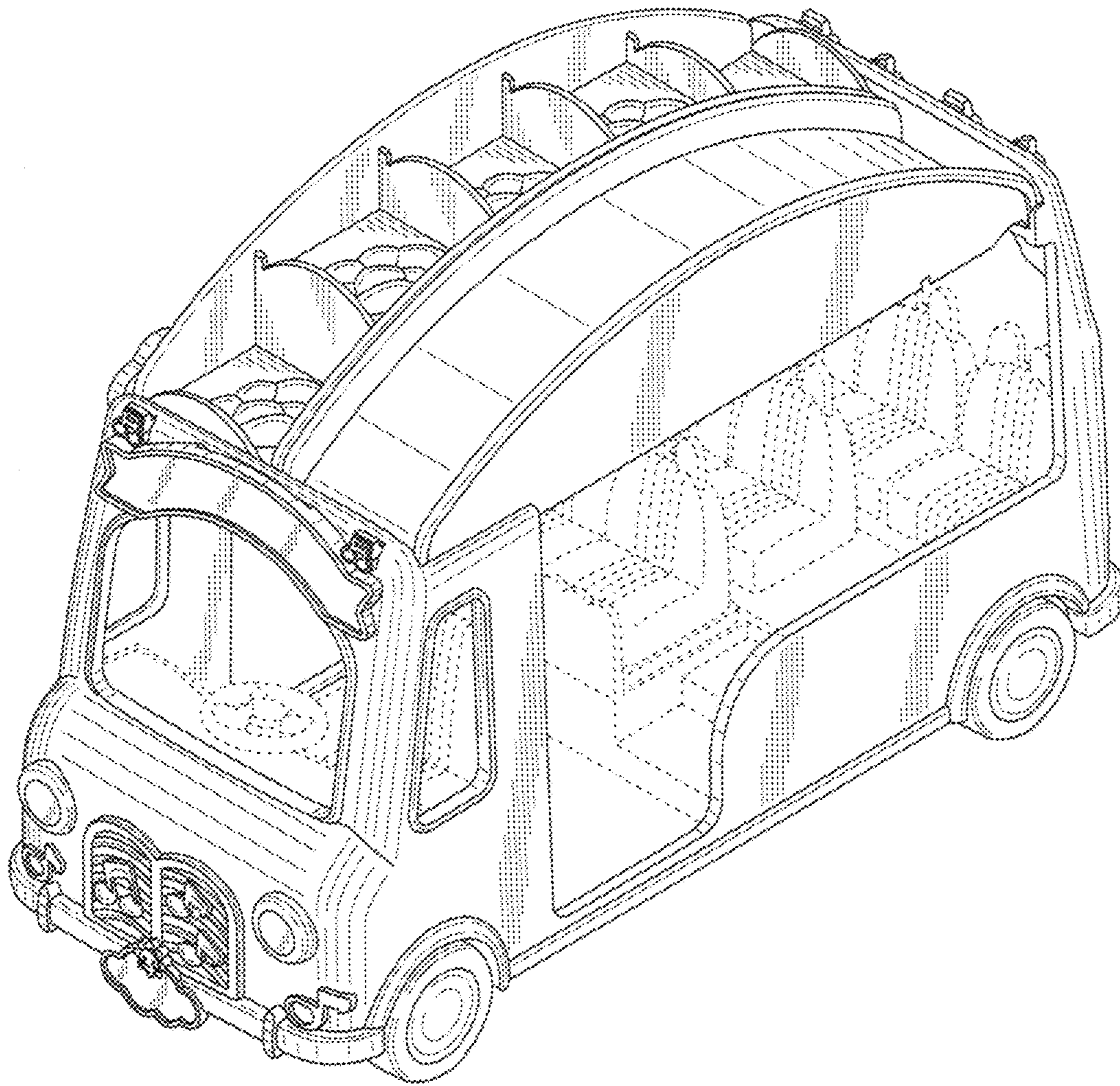

FIG. 2

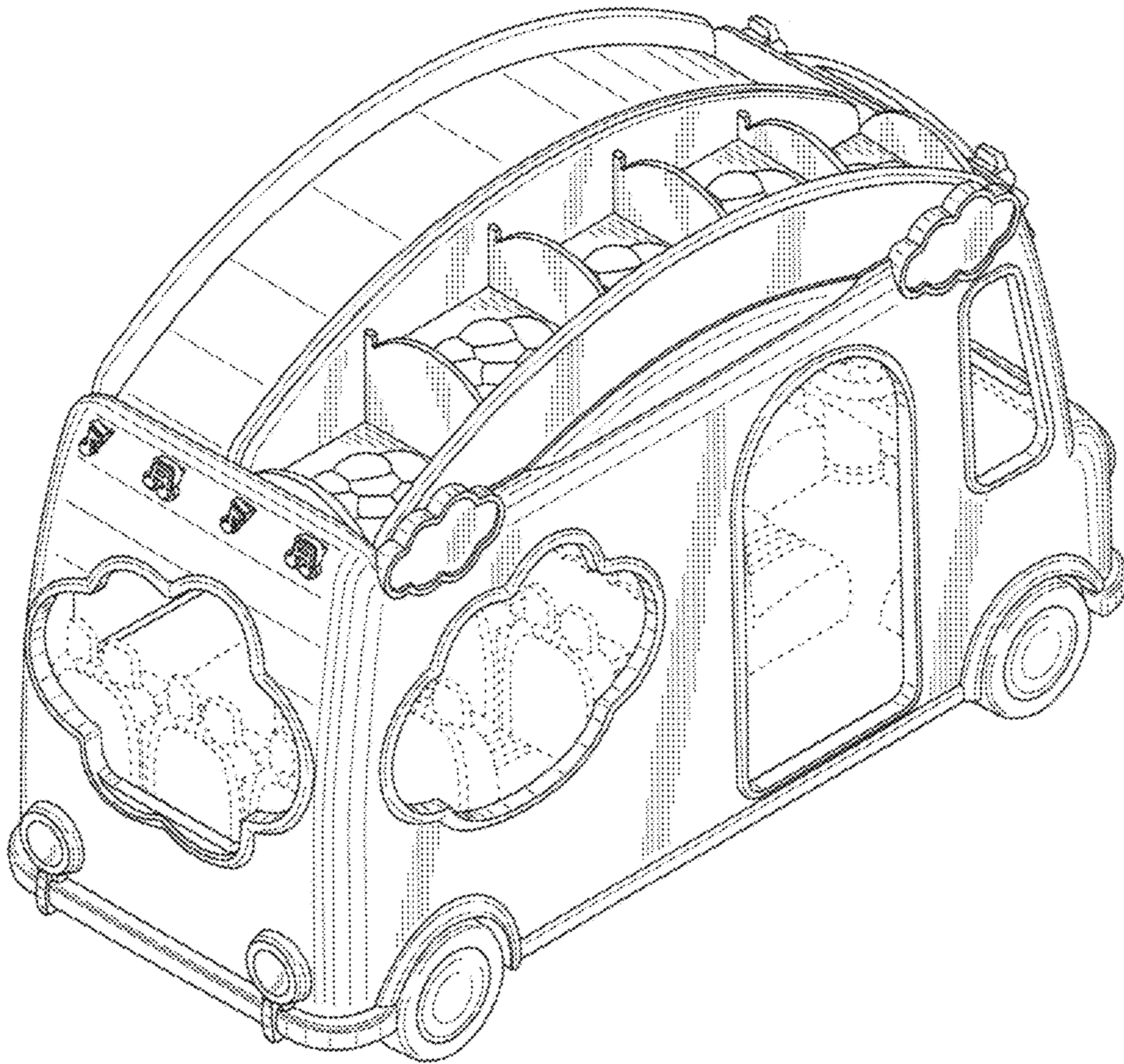

FIG. 3

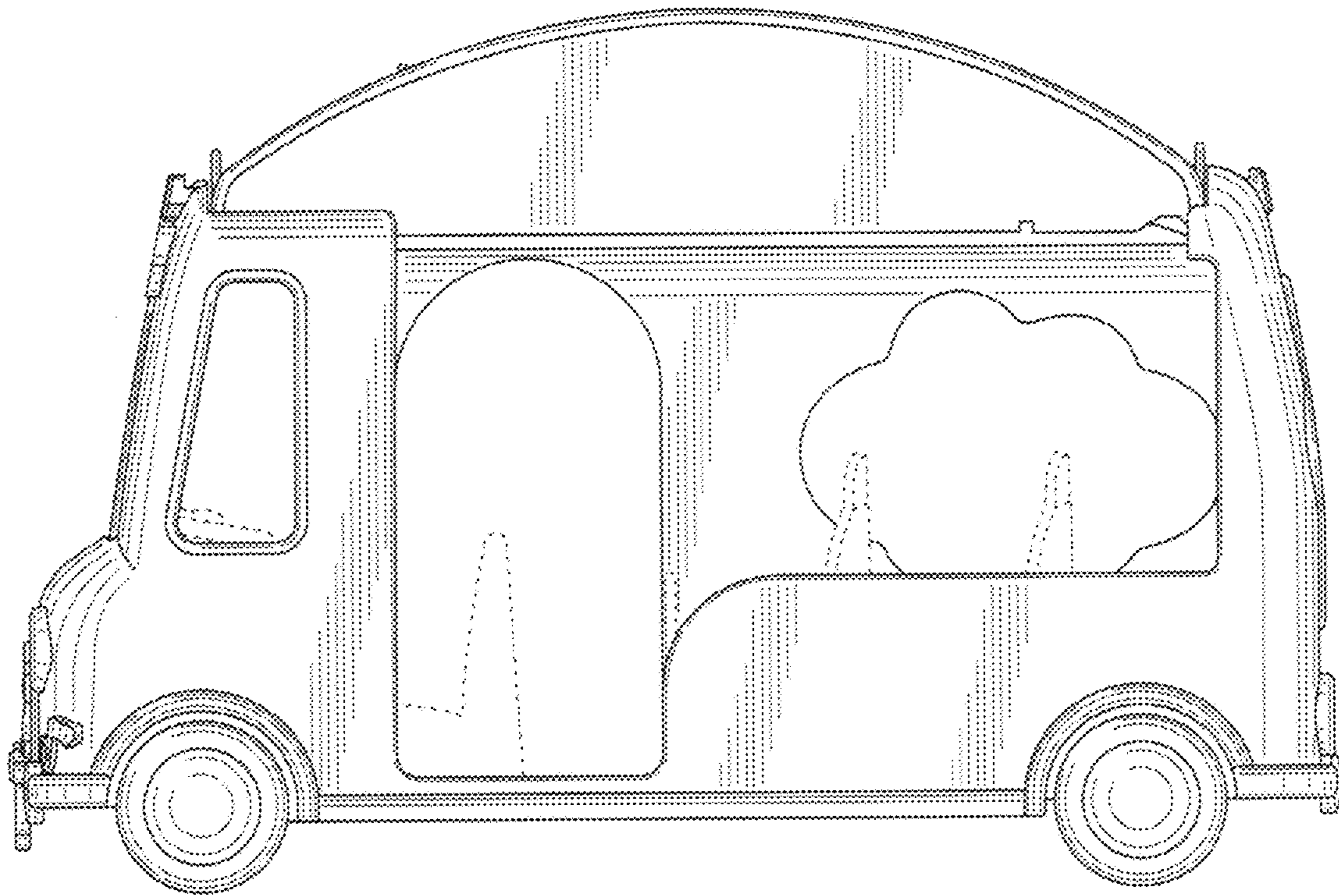

FIG. 4

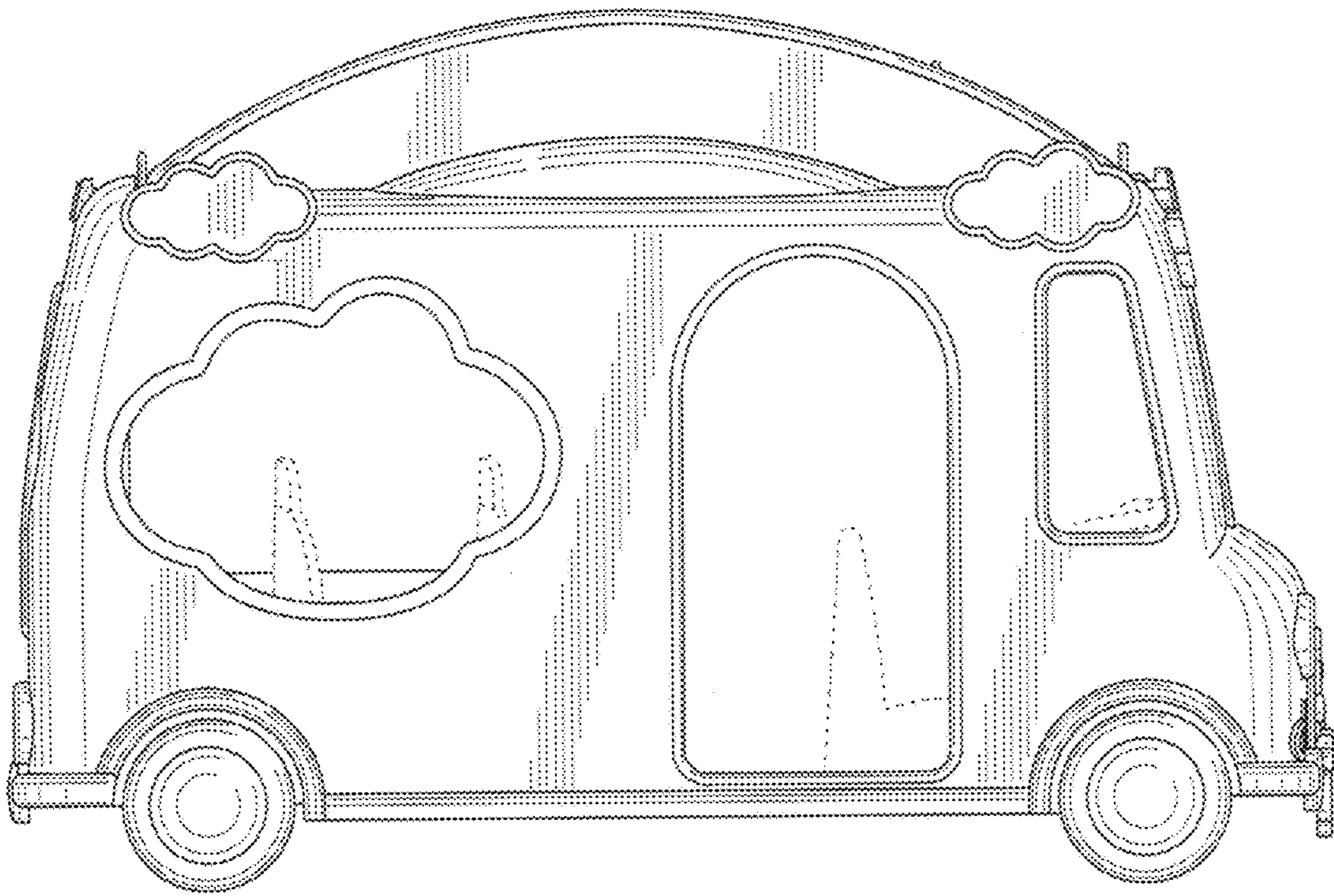

FIG. 5

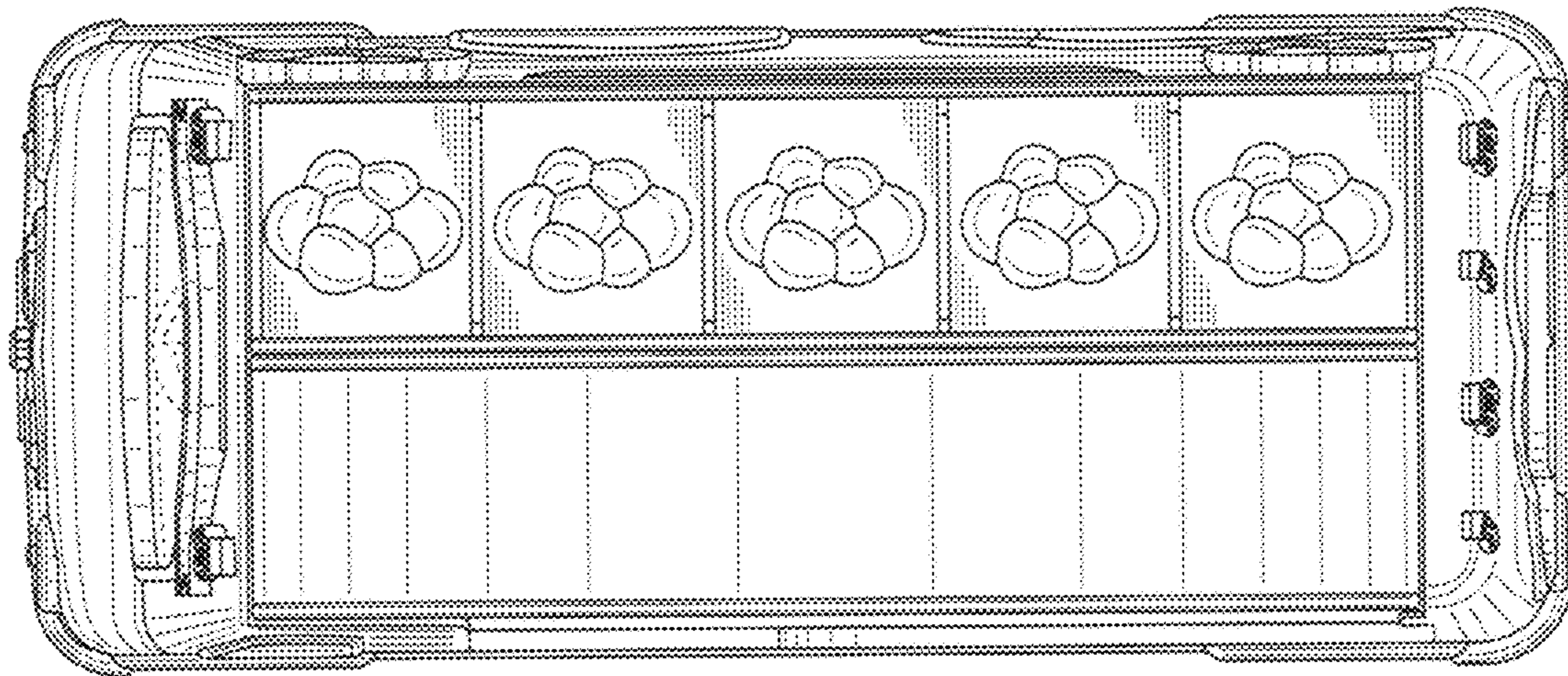

FIG. 6

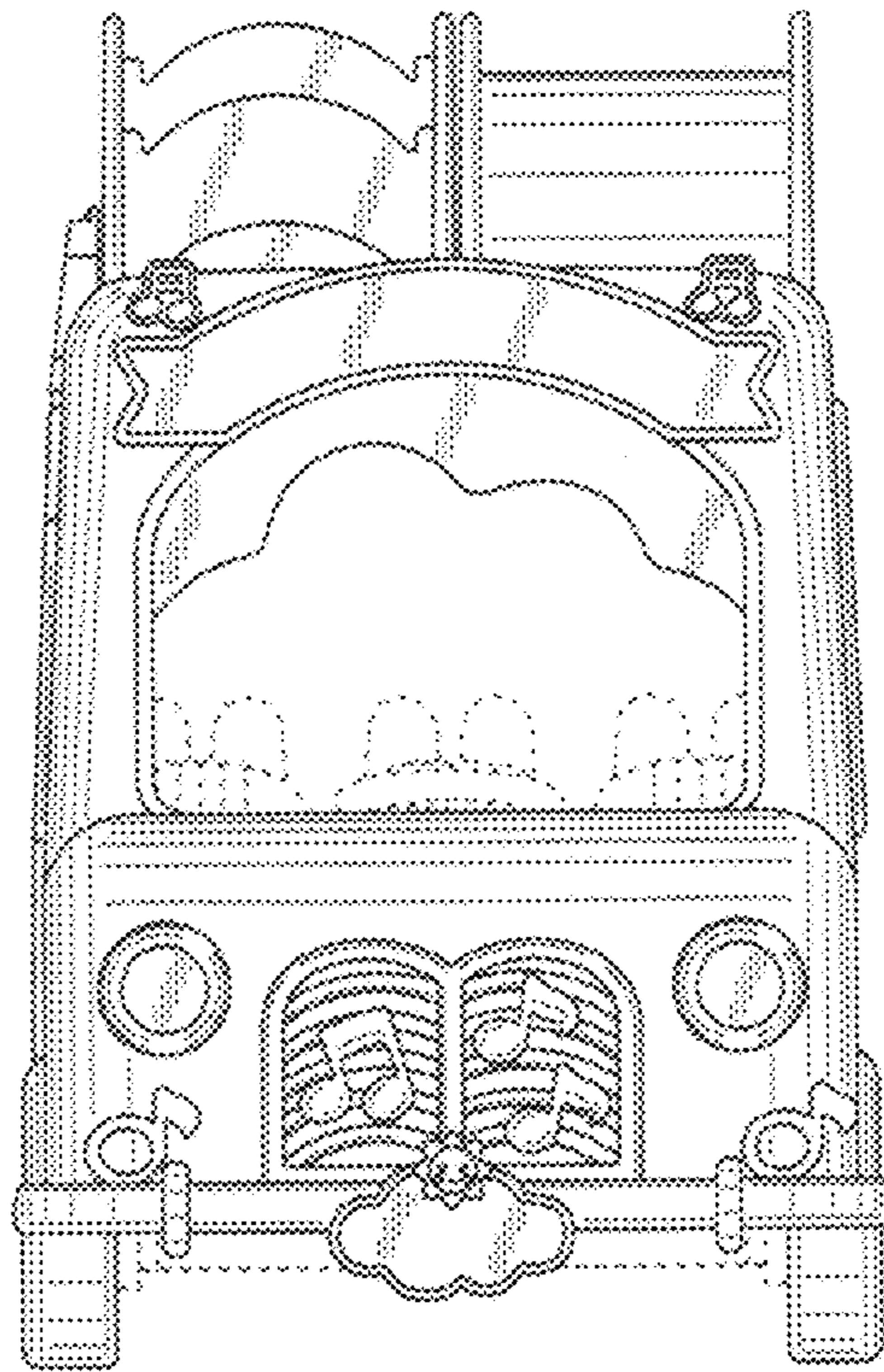

FIG. 8

