



US00D852788S

(12) **United States Design Patent**
Kanter

(10) **Patent No.:** **US D852,788 S**
(45) **Date of Patent:** **** Jul. 2, 2019**

- (54) **MOUNT ADAPTER BRACKET**
- (71) Applicant: **HumanCentric Ventures LLC**, Skokie, IL (US)
- (72) Inventor: **Simcha Kanter**, Chicago, IL (US)
- (73) Assignee: **HUMANCENTRIC VENTURES LLC**, Skokie, IL (US)

- D565,938 S 4/2008 Massoumi et al.
- D576,633 S 9/2008 Muday et al.
- D560,677 S 11/2008 Wohlford et al.
- D587,100 S 2/2009 Allsopp
- 7,544,889 B1 6/2009 Sanchez
- D612,226 S 3/2010 Dinh
- D628,539 S 12/2010 Tezak et al.
- D628,566 S 12/2010 Molter
- D645,902 S 9/2011 Tsai

(Continued)

(**) Term: **15 Years**

FOREIGN PATENT DOCUMENTS

(21) Appl. No.: **29/641,700**

GB 2433196 A 6/2007

(22) Filed: **Mar. 23, 2018**

OTHER PUBLICATIONS

(51) **LOC (11) Cl.** **14-03**

(52) **U.S. Cl.**
USPC **D14/238**

(58) **Field of Classification Search**
USPC D8/354, 349, 355, 363, 373, 380, 387,
D8/388, 389; D20/22, 27, 42, 43;
D6/315, 320, 328, 319; D14/238
CPC H05K 5/0204; H05K 7/14; F16M 13/02;
H04N 5/655; H04N 5/64; G06F 1/1601;
G06F 1/16; A45F 5/00; A45F 5/021;
A45F 2200/0516; A45F 2200/0508; A45F
2200/0525

Amazon.com, Vesa Mount Adapter, Date Made Available Dec. 26, 2017, Amazon, [https://www.amazon.com/Mount-Adapter-Monitors-Patent-Pending/dp/B078MN77TD/ref=sr_1_17?ie=UTF8&qid=1546415020&sr=8-17&keywords=vesa+mount+adapter+\(Year:2017\).*](https://www.amazon.com/Mount-Adapter-Monitors-Patent-Pending/dp/B078MN77TD/ref=sr_1_17?ie=UTF8&qid=1546415020&sr=8-17&keywords=vesa+mount+adapter+(Year:2017).*)

(Continued)

Primary Examiner — Janice Hallmark
Assistant Examiner — Harold E Blackwell, II
(74) *Attorney, Agent, or Firm* — DLA Piper LLP (US)

See application file for complete search history.

(57) **CLAIM**

The ornamental design for a mount adapter bracket, as shown and described.

(56) **References Cited**

DESCRIPTION

U.S. PATENT DOCUMENTS

- D158,122 S 4/1949 Pennington
- 5,810,303 A 9/1998 Bourassa
- D442,469 S 5/2001 Roozen et al.
- 6,749,162 B2 6/2004 Nicolides et al.
- D504,701 S 5/2005 Chen
- D536,240 S 2/2007 Vejmarker
- D557,126 S 12/2007 Worrall et al.
- D558,560 S 1/2008 Ciungan
- D560,221 S 1/2008 Hoglan et al.
- D560,222 S 1/2008 Anderson
- D560,674 S 1/2008 Wohlford et al.

FIG. 1 is a perspective view of the mount adapter bracket. FIG. 2 is a front view of the mount adapter bracket. FIG. 3 is a back view of the mount adapter bracket. FIG. 4 is a left side view of the mount adapter bracket, the right side view of the mount adapter bracket being a mirror image thereof. FIG. 5 is a top view of the mount adapter bracket; and, FIG. 6 is a bottom view of the mount adapter bracket.

1 Claim, 4 Drawing Sheets

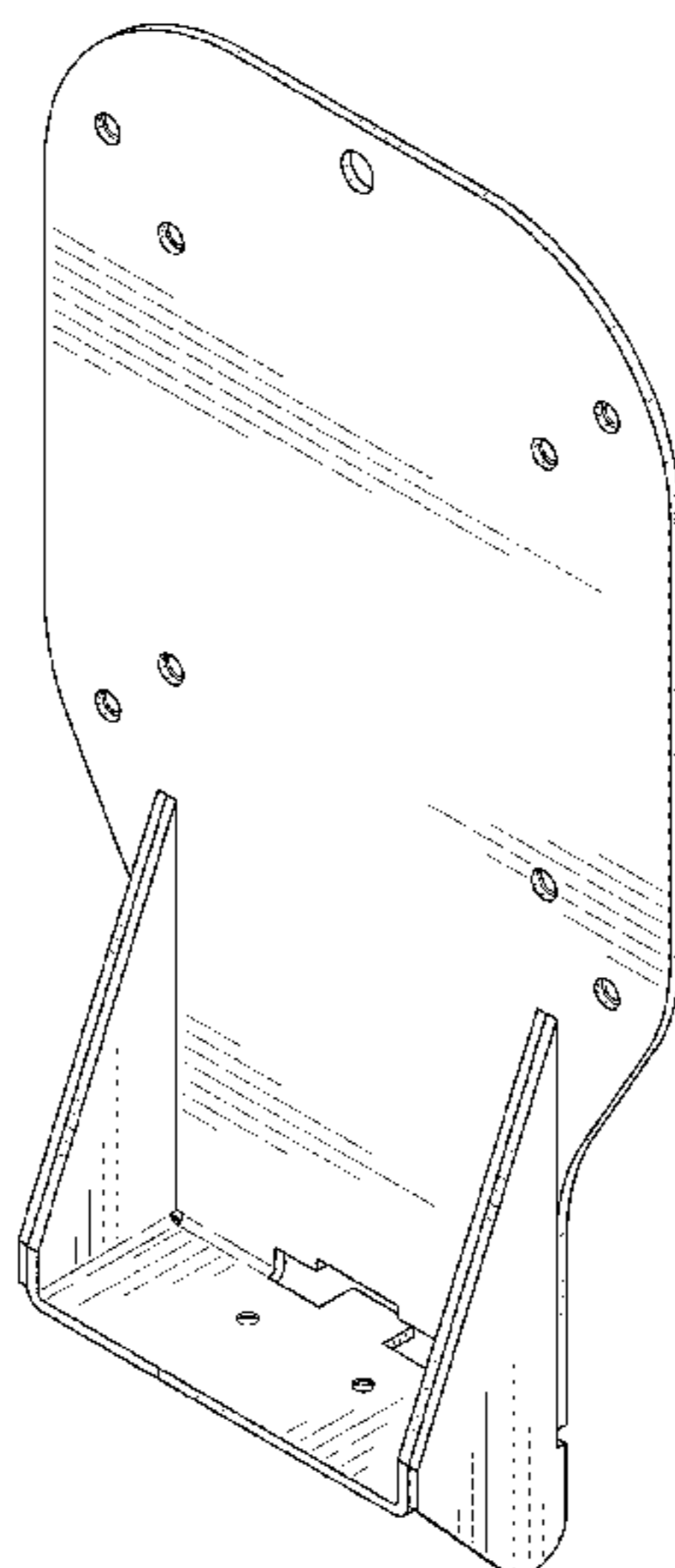

(56)

References Cited

U.S. PATENT DOCUMENTS

D650,987	S	12/2011	Rothbauer	
D652,411	S	1/2012	Crawford et al.	
D667,249	S	9/2012	London	
D667,288	S	9/2012	Preda	
D677,263	S	3/2013	Luijben et al.	
D682,079	S	5/2013	Chou	
D688,670	S	8/2013	Huang	
8,511,032	B2	8/2013	Abdei-Rahman et al.	
D689,045	S	9/2013	Mardas	
RE44,515	E	10/2013	Ciungan et al.	
RE44,740	E	2/2014	Ciungan	
D729,611	S	5/2015	Schmidt	
D743,955	S	11/2015	Wu	
D749,399	S	2/2016	Jenkins	
D750,603	S *	3/2016	Venghaus	D14/238
D760,066	S	6/2016	Krenek	
D761,236	S	7/2016	Wengreen	
D767,575	S	9/2016	Green	
D769,024	S	10/2016	Montoya	
D788,951	S	6/2017	Lopez	
D789,565	S	6/2017	Lopez	
D794,420	S	8/2017	Emmons	
D794,424	S	8/2017	Thompson et al.	
D807,152	S	1/2018	Hansen	
D810,091	S	2/2018	Cho	
D813,020	S	3/2018	DeDios-Shirley	
9,929,549	B2	3/2018	Witherbee et al.	
D822,453	S *	7/2018	Kanter	D8/354
D822,454	S *	7/2018	Kanter	D8/354
D823,093	S *	7/2018	Kanter	D8/354
D823,094	S *	7/2018	Kanter	D8/354
D829,531	S *	10/2018	Kanter	D8/354
D829,533	S *	10/2018	Kanter	D8/354
D833,851	S *	11/2018	Kanter	D8/354
2012/0025046	A1	2/2012	Yen	
2015/0264823	A1	9/2015	Shirley	

OTHER PUBLICATIONS

Vesa Mount Adapter Bracket for Samsung CF591, posted at amazon.com, posting date Mar. 30, 2017, [online], [site visited Mar. 27, 2018]. Available from Internet, U RL: <https://www.arnazon.com/Adapter-Bracket-Sarnsung-27-inch-LC27F591FDNXZA/dp/B06XXPJZH 1/> (Year:2017).

Vesa Mount Adapter Bracket for Samsung Monitors, posted at amazon.com, posting date Oct. 26, 2015, [online], [site visited Mar.

27, 2018]. Available from Internet, U RL: <https://www.arnazon.com/Monitors-S27D390H-S24D390HL-S27D360H-S24D360HL/dp/B01771PV3K/> (Year:2015).

Vesa Mount Adapter for Acer H2 Monitors, posted at amazon.com, posting date Mar. 22, 2016, [online], [site visited Mar. 27, 2018]. Available from Internet, U RL: <https://www.amazon.com/Mount-Adapter-H277H-U-H257H-U-Monitors/dp/B01DAYRVG8/> (Year: 2016).

Vesa Mount Adapter for Asus MX Monitors, posted at amazon.com, posting date Feb. 3, 2016, [online], [site visited Mar. 27, 2018]. Available from Internet, URL: <https://www.arnazon.com/Adapter-Monitors-MX239H-MX259H-MX279H/dp/B01BFWROZU/> (Year: 2016)

Vesa Mount Adapter for Asus VX-Series Monitors, posted at amazon.com, posting date Mar. 22, 2016, [online], [site visited Mar. 28, 2018]. Available from Internet, U RL: <https://www.amazon.com/Adapter-SE2416HX-SE2717HX-SE2717H-SE2417HG/dp/B01DAYR3ZM/> (Year: 2016).

Related U.S. Appl. No. 29/591,809 electronically captured on Jun. 19, 2018.

Related U.S. Appl. No. 29/594,376 electronically captured on Jun. 19, 2018.

Related U.S. Appl. No. 29/594,765 electronically captured on Jun. 19, 2018.

Related U.S. Appl. No. 29/594,429 electronically captured on Jun. 19, 2018.

Related U.S. Appl. No. 29/594,766 electronically captured on Jun. 19, 2018.

Related U.S. Appl. No. 29/594,362 electronically captured on Jun. 19, 2018.

Related U.S. Appl. No. 29/599,976 electronically captured on Jun. 19, 2018.

Related U.S. Appl. No. 29/599,971 electronically captured on Jun. 19, 2018.

Related U.S. Appl. No. 29/614,613 electronically captured on Jun. 19, 2018.

U.S. Appl. No. 29/591,809, filed Jan. 24, 2017, Pending.

U.S. Appl. No. 29/594,376, filed Feb. 17, 2017, Allowed.

U.S. Appl. No. 29/594,765, filed Feb. 22, 2017, Allowed.

U.S. Appl. No. 29/594,429, filed Feb. 17, 2017, Allowed.

U.S. Appl. No. 29/594,766, filed Feb. 22, 2017, Pending.

U.S. Appl. No. 29/594,362, filed Feb. 17, 2017, Allowed.

U.S. Appl. No. 29/599,976, filed Apr. 7, 2017, Allowed.

U.S. Appl. No. 29/599,971, filed Apr. 7, 2017, Pending.

U.S. Appl. No. 29/614,613, filed Aug. 21, 2017, Pending.

U.S. Appl. No. 29/641,700, filed Mar. 23, 2018, Pending.

* cited by examiner

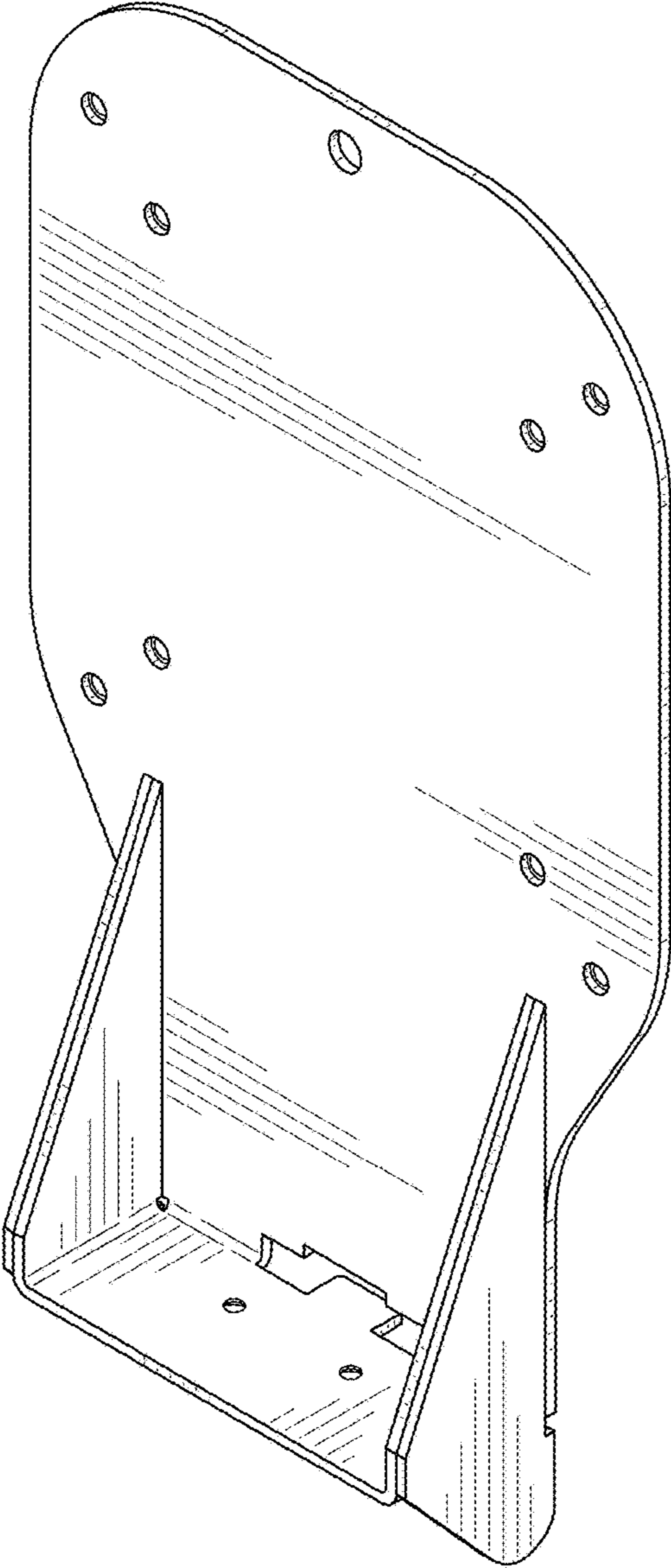

FIG. 1

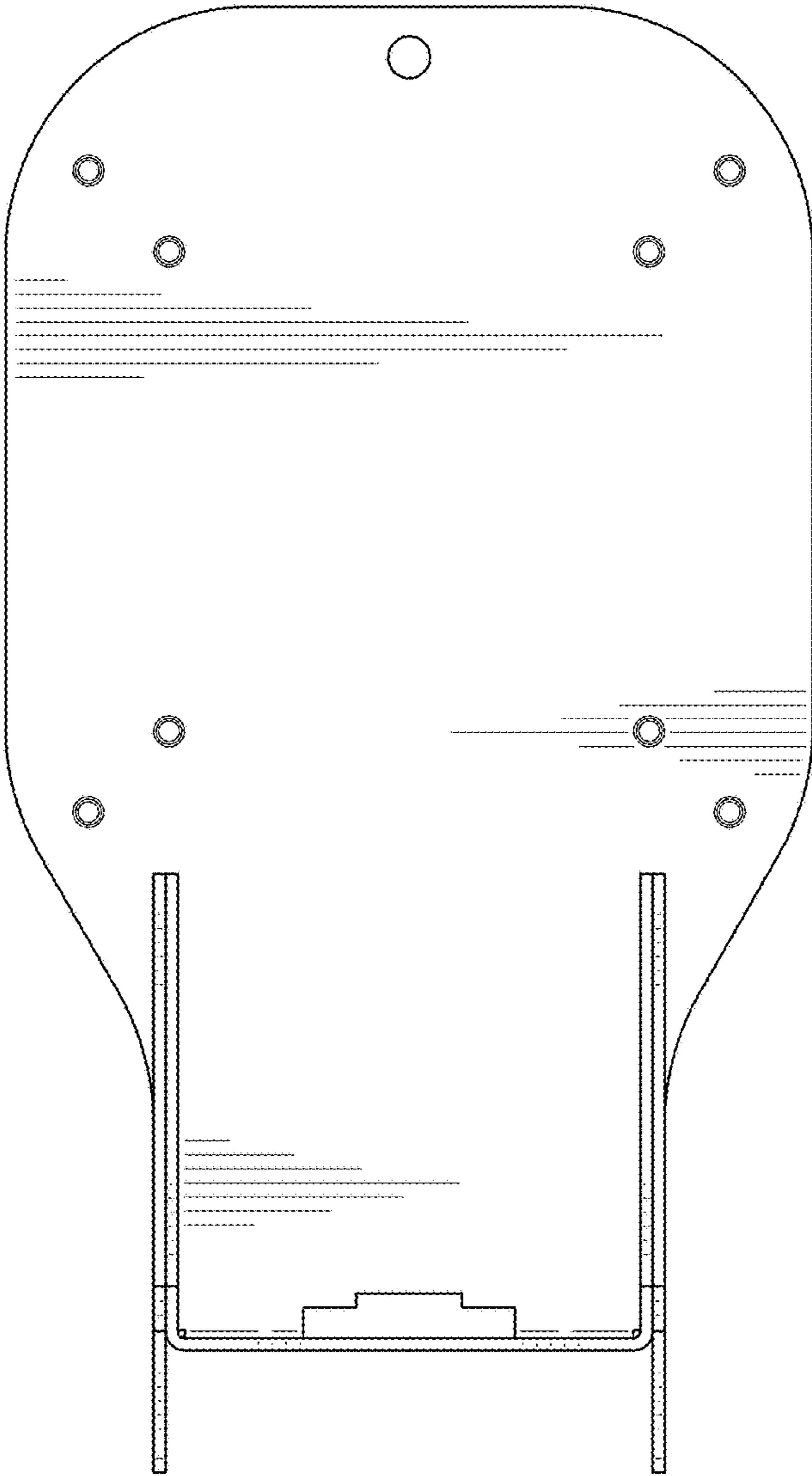

FIG. 2

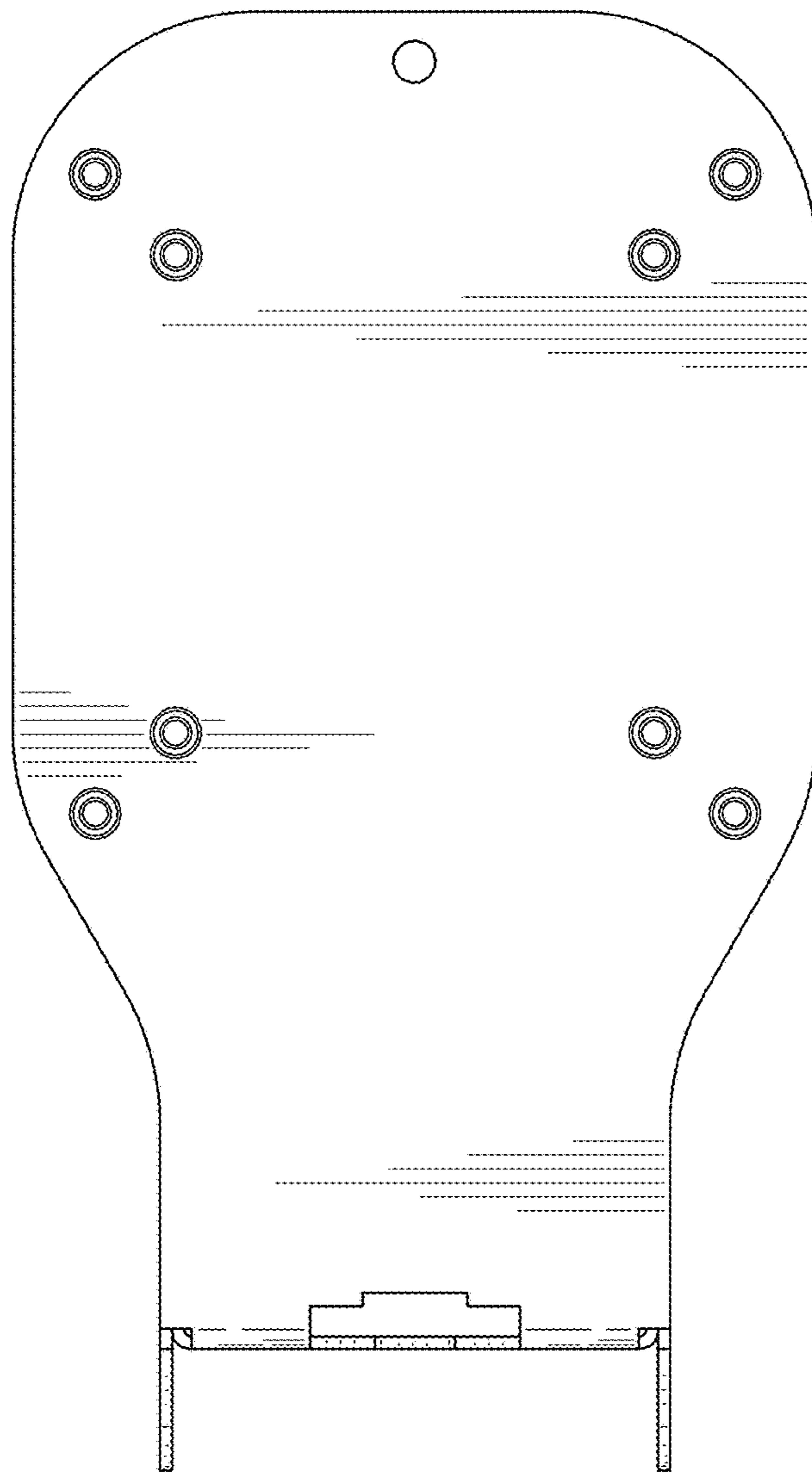

FIG. 3

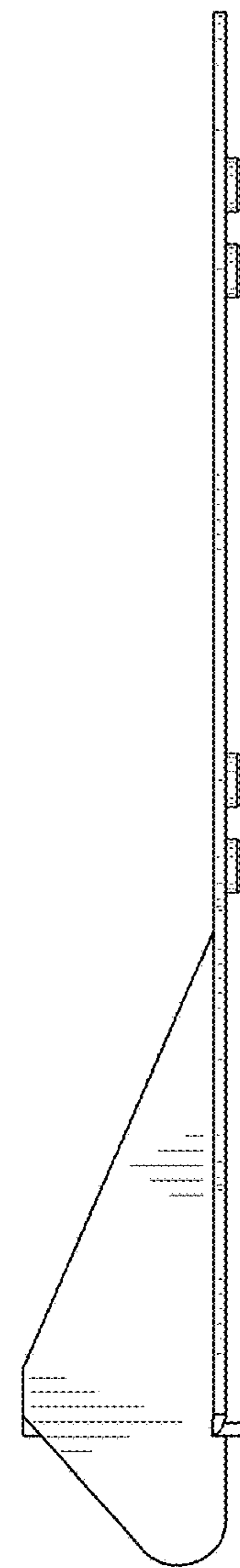

FIG. 4

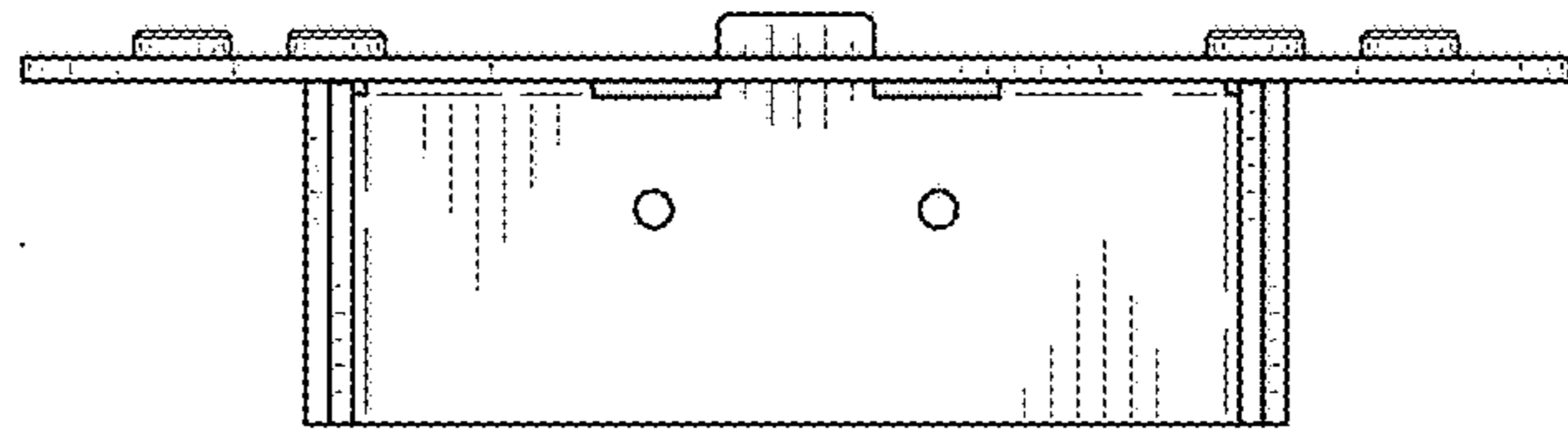

FIG. 5

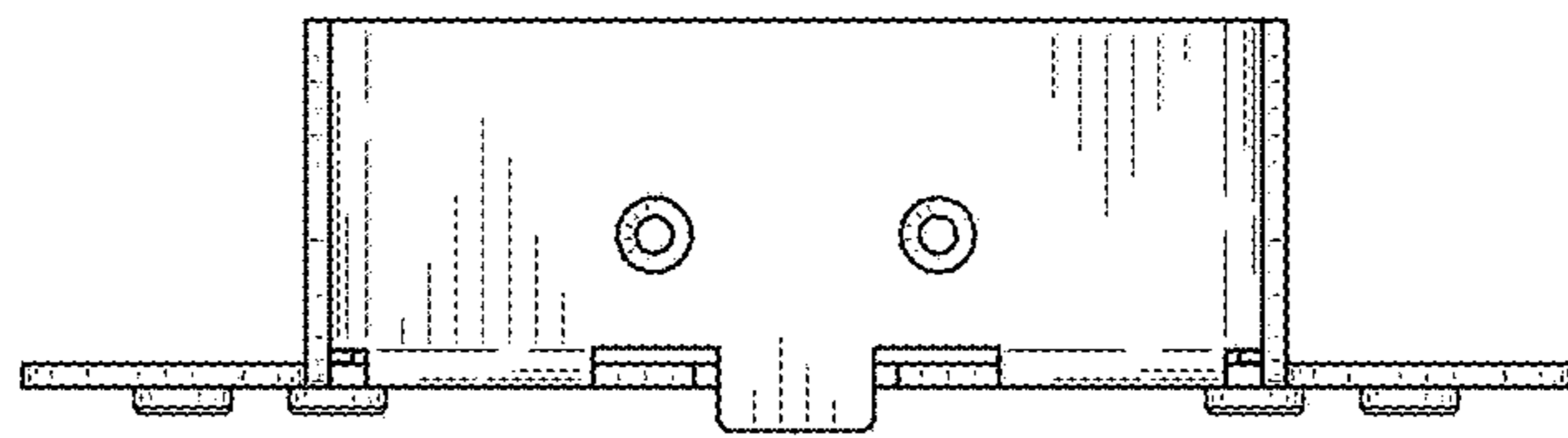

FIG. 6