



US00D852767S

(12) **United States Design Patent**  
**Kim et al.**

(10) **Patent No.:** **US D852,767 S**  
(45) **Date of Patent:** **\*\* Jul. 2, 2019**

(54) **TELEVISION APPARATUS**  
(71) Applicant: **LG ELECTRONICS INC**, Seoul (KR)  
(72) Inventors: **Huisik Kim**, Seoul (KR); **Hodong Hwang**, Seoul (KR)  
(73) Assignee: **LG ELECTRONICS INC.**, Seoul (KR)

D484,471 S \* 12/2003 Lin ..... D14/126  
D487,742 S \* 3/2004 Huang ..... D14/341  
D490,420 S \* 5/2004 Solomon ..... D14/341  
D567,777 S \* 4/2008 Lin ..... D14/126  
D568,285 S \* 5/2008 Lee ..... D14/138 G  
D568,618 S \* 5/2008 Harrington ..... D6/300  
(Continued)

(\*\*) Term: **15 Years**

(21) Appl. No.: **35/503,826**

(22) Filed: **Apr. 12, 2017**

(80) **Hague Agreement Data**

Int. Filing Date: **Apr. 12, 2017**  
Int. Reg. No.: **DM/095753**  
Int. Reg. Date: **Apr. 12, 2017**  
Int. Reg. Pub. Date: **Oct. 13, 2017**

(30) **Foreign Application Priority Data**

Oct. 18, 2016 (KR) ..... 30-2016-0049933

(51) **LOC (11) Cl.** ..... **14-03**

(52) **U.S. Cl.**  
USPC ..... **D14/126**

(58) **Field of Classification Search**  
USPC ..... D14/125-134, 239, 314-316, 322, 326,  
D14/334-336, 339-341, 371, 373-374,  
D14/448, 450; D21/329, 332, 515  
CPC ..... G06F 1/16; G06F 1/1601; G06F 1/1637;  
H04N 5/64; H05K 5/0204; H05K 5/0017;  
H05K 5/0217

See application file for complete search history.

(56) **References Cited**

**U.S. PATENT DOCUMENTS**

D370,355 S \* 6/1996 Kenney ..... D6/310  
6,212,069 B1 \* 4/2001 Janik ..... G06F 1/1616  
165/86

**OTHER PUBLICATIONS**

32 Inch DLED LED TV 2017, posted at Dhgate, posting date not available. [site visited Jul. 8, 2018] [Available from internet] URL: <<https://www.dhgate.com/product/32-inch-dled-led-tv-2017-new-style-design/412022215.html>>.\*

(Continued)

*Primary Examiner* — George D. Kirschbaum  
*Assistant Examiner* — Kathleen L Jones  
(74) *Attorney, Agent, or Firm* — Birch, Stewart, Kolasch & Birch, LLP

(57) **CLAIM**

The ornamental design for a television apparatus, as shown and described.

**DESCRIPTION**

- 1. Television apparatus
- 1.1 : Perspective
- 1.2 : Front
- 1.3 : Back
- 1.4 : Left
- 1.5 : Right
- 1.6 : Top
- 1.7 : Bottom
- 1.8 : Enlarged
- 1.9 : Enlarged

The evenly-spaced broken lines show portions of the article; the smaller unevenly-spaced broken lines define the bounds of the claimed design; the larger unevenly-spaced broken lines are used to indicate the sections of the views shown enlarged; all broken lines form no part of the claimed design.

**1 Claim, 8 Drawing Sheets**

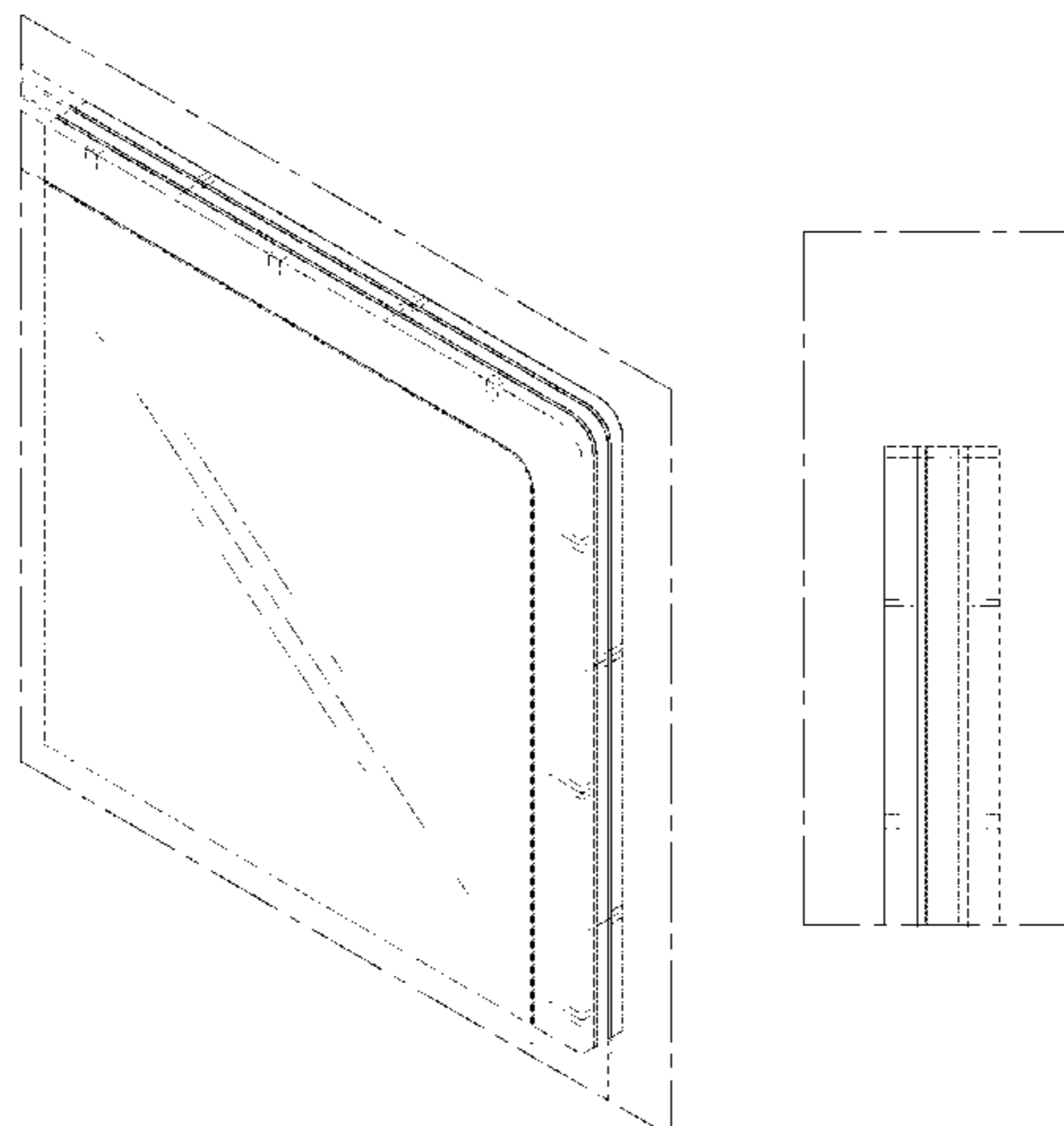

(56)

References Cited

OTHER PUBLICATIONS

U.S. PATENT DOCUMENTS

D595,712 S \* 7/2009 Guery ..... D14/341  
 D625,307 S \* 10/2010 Cheng ..... D14/341  
 D626,437 S \* 11/2010 Lee ..... D10/65  
 D673,950 S \* 1/2013 Li ..... D14/341  
 D696,246 S \* 12/2013 Kim ..... D14/341  
 D712,400 S \* 9/2014 Kim ..... D14/341  
 D723,552 S \* 3/2015 Clegg ..... D14/341  
 D783,554 S \* 4/2017 Kim ..... D14/126  
 D793,985 S \* 8/2017 Lee ..... D14/138 G  
 D796,465 S \* 9/2017 Kim ..... D14/126  
 D805,490 S \* 12/2017 Lim ..... D14/126  
 D810,075 S \* 2/2018 Liu ..... D14/341  
 D813,833 S \* 3/2018 Won ..... D14/126  
 D815,633 S \* 4/2018 Akana ..... D14/341  
 D819,018 S \* 5/2018 Tsai ..... D14/341  
 D820,231 S \* 6/2018 Cha ..... D14/126  
 D820,253 S \* 6/2018 Kim ..... D14/341  
 D820,827 S \* 6/2018 Seoc ..... D14/315  
 2013/0258212 A1 \* 10/2013 Ooe ..... H04N 5/64  
 348/836  
 2014/0233167 A1 \* 8/2014 Rayner ..... H01H 13/06  
 361/679.3

Nextbook Flexx 10.1\_2-in-1 Tablet, posted at Walmart, review posted Nov. 26, 2015. [site visited Jul. 8, 2018] [Available from internet] URL: <<https://www.walmart.com/ip/Nextbook-Flexx-10-1-2-in-1-Tablet-32GB-Intel-Atom-Z3735F-Quad-Core-Processor-Windows-10-Black/46664255>> (Year: 2015).\*

Teoh, Vincent, Sony Bravia XE85, posted at Expert Reviews, posting date Jan. 12, 2018. [site visited Jul. 8, 2018] [Available from internet] URL: <<http://www.expertreviews.co.uk/tvs/1406640/sony-bravia-xe85-kd-55xe8596-review-good-but-not-great>> (Year: 2018).\*

Archer, John, Toshiba 32AV555DB 32in LCD TV, posting date Feb. 5, 2011. [site visited Jul. 8, 2018] [Available from internet] URL: <<https://www.trustedreviews.com/reviews/toshiba-32av555db-32in-lcd-tv>> (Year: 2011).\*

\* cited by examiner

1.1

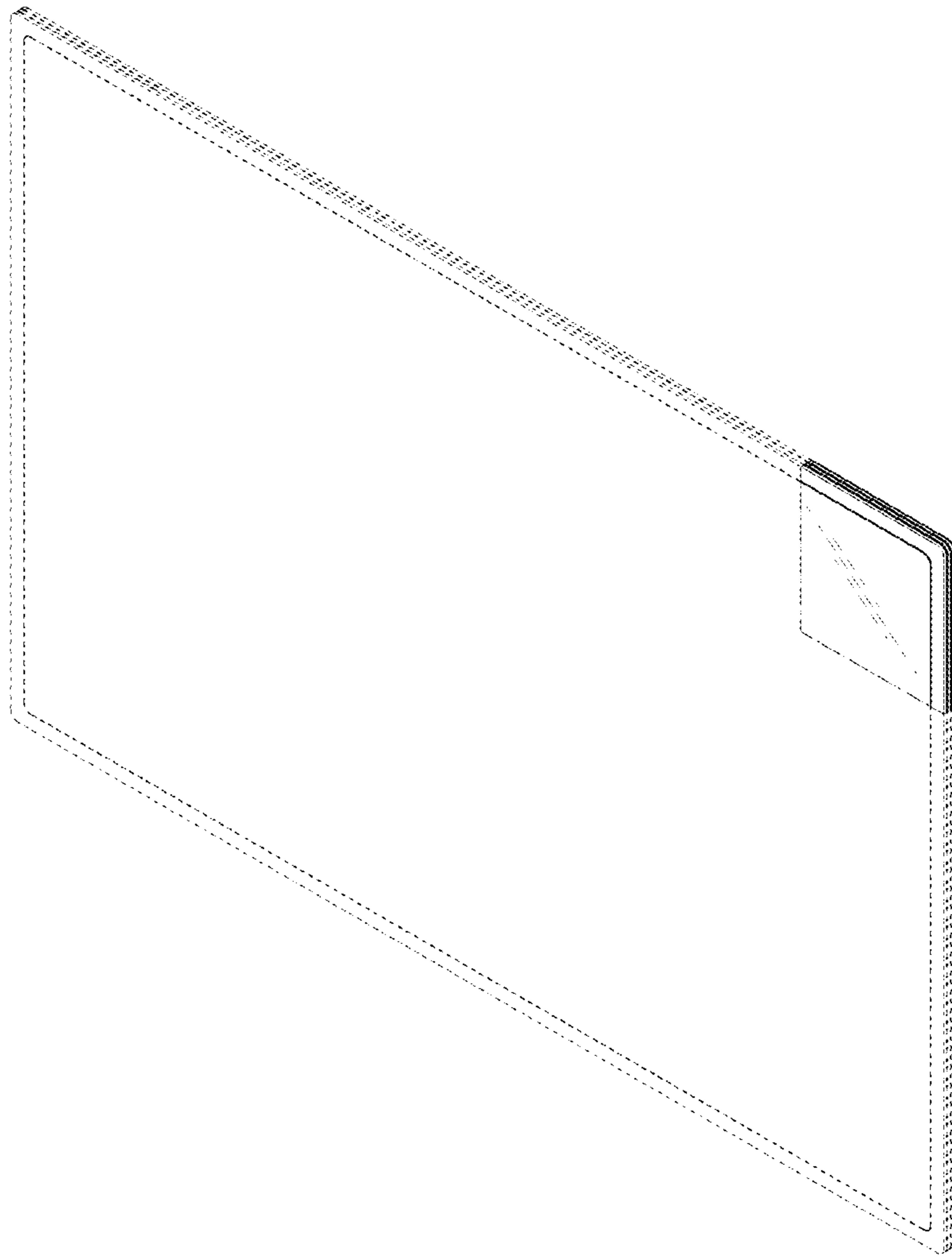

1.2



1.3

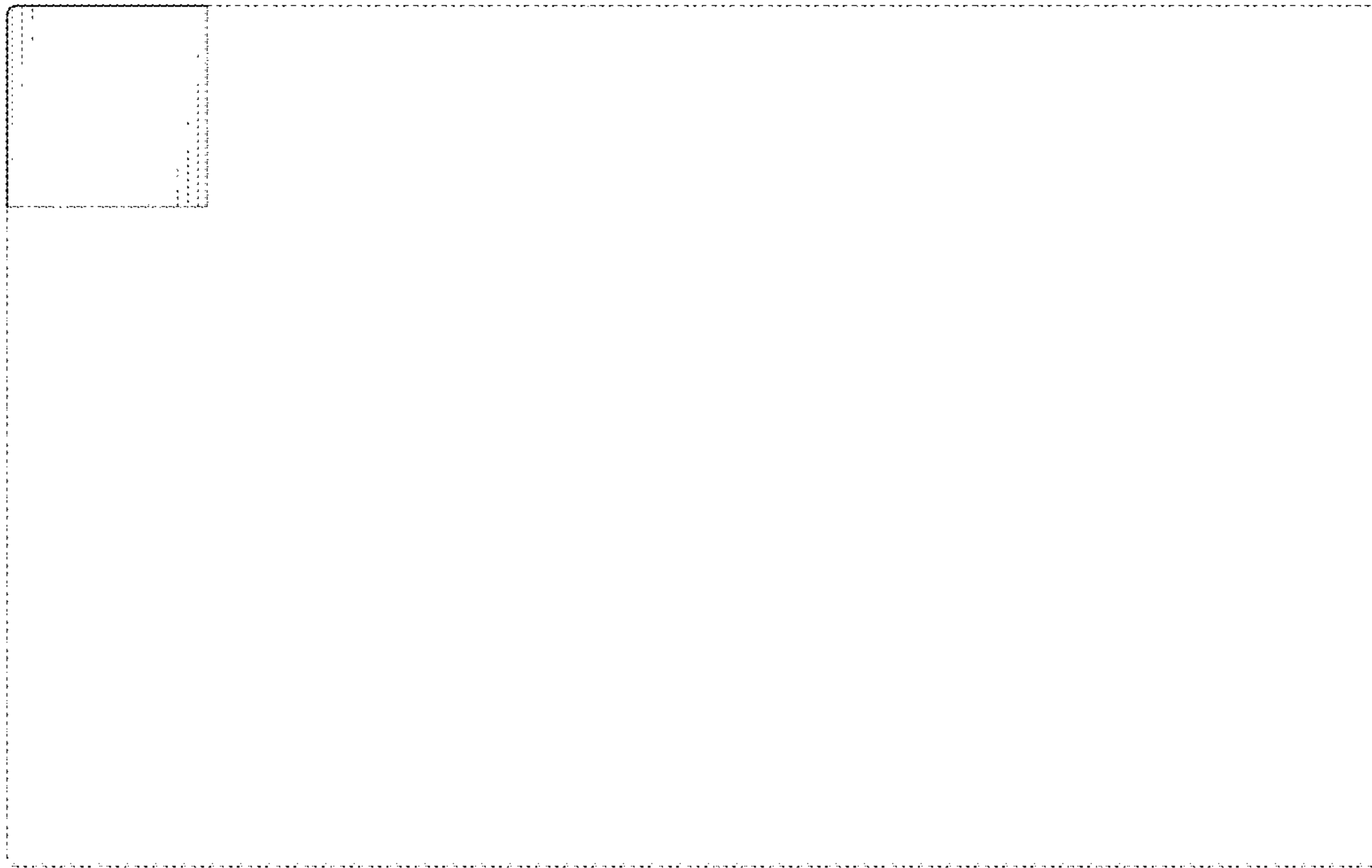

1.4

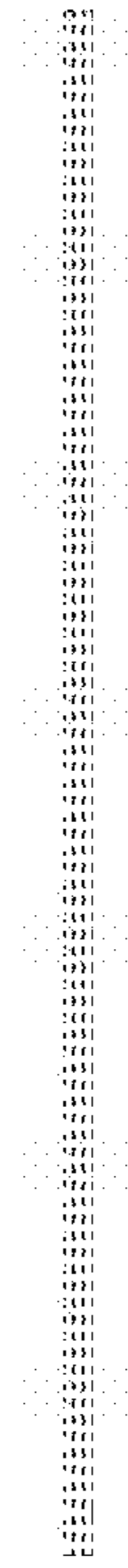

1.5

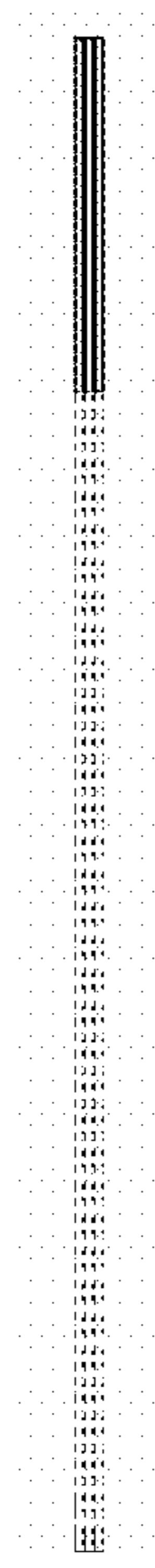

1.6

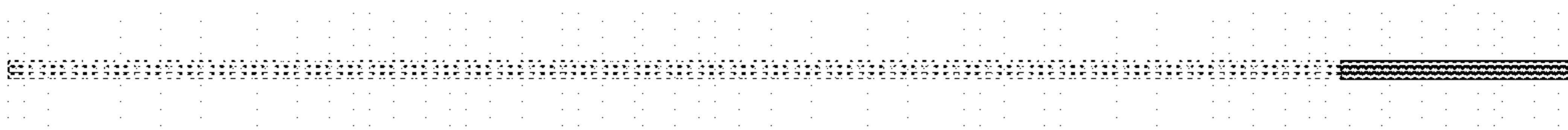

1.7

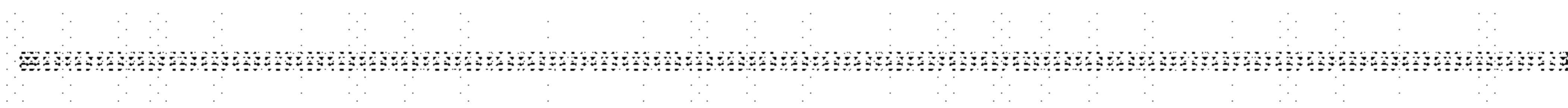



1.8

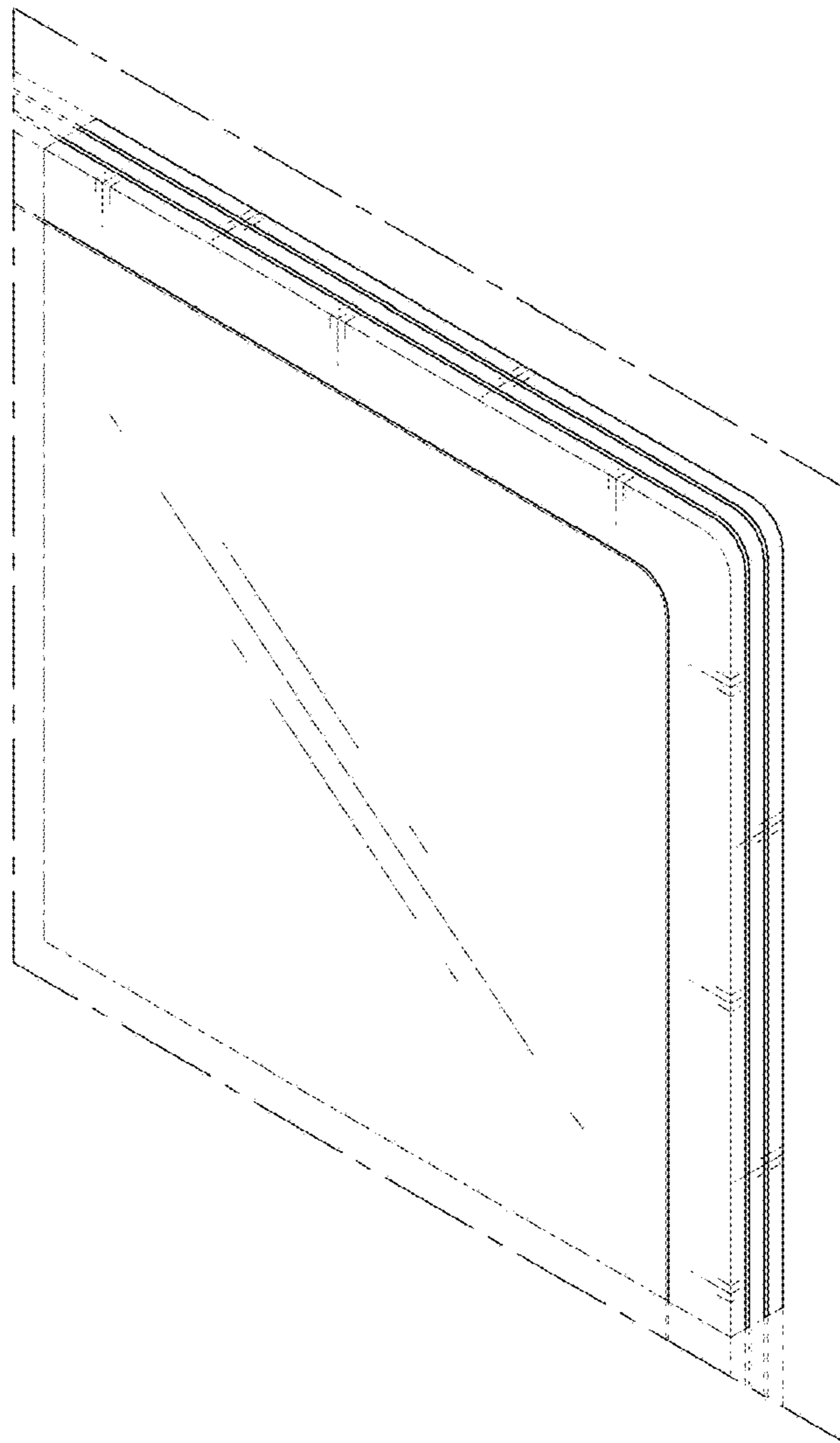

1.9

