



US00D852573S

(12) **United States Design Patent** (10) **Patent No.:** **US D852,573 S**  
**Bassill** (45) **Date of Patent:** **\*\* Jul. 2, 2019**

(54) **INDUCTION WARMER**  
(71) Applicant: **HATCO CORPORATION**,  
Milwaukee, WI (US)  
(72) Inventor: **Nicholas Bassill**, Malibu, CA (US)  
(73) Assignee: **HATCO CORPORATION**,  
Milwaukee, WI (US)  
(\*\*) Term: **15 Years**  
(21) Appl. No.: **29/604,242**  
(22) Filed: **May 16, 2017**  
(51) **LOC (11) Cl.** ..... **07-02**  
(52) **U.S. Cl.**  
USPC ..... **D7/363**  
(58) **Field of Classification Search**  
USPC ..... D7/354-365, 367, 402-404, 407-409,  
D7/417, 339, 346, 347, 332-334  
CPC ..... A47J 47/02; A47J 47/14; A47J 2027/043;  
A47J 27/04; A47J 27/05; A47J 27/17;  
A47J 27/16; A47J 33/00; A23L 5/13;  
B65D 39/00; B65D 43/00; B65D 43/02;  
B65D 43/14; F24C 15/10; F24C 15/101;  
F24C 15/102; F24C 15/107; F24C  
15/108; F24C 15/26; F24C 3/14; F24C  
1/16; F24C 5/20; F23D 14/06; F23D  
14/38; F23D 14/56; F23D 14/465; F23D  
14/52; F23D 2900/14062; F23D  
2900/14063; H05B 6/02; H05B 6/06;  
H05B 6/062; H05B 6/12; H05B 6/1209;  
H05B 2213/07  
See application file for complete search history.

(56) **References Cited**  
U.S. PATENT DOCUMENTS  
D204,070 S \* 3/1966 Kramer ..... D7/363  
D249,917 S \* 10/1978 Collins ..... D7/356  
D285,523 S \* 9/1986 Ayukawa ..... D7/367  
D296,509 S \* 7/1988 Fuke ..... D7/363

D438,423 S \* 3/2001 Bassill ..... D7/367  
D501,117 S \* 1/2005 Bassill ..... D7/367  
D685,605 S \* 7/2013 Xin ..... D7/352

(Continued)

*Primary Examiner* — Barbara Fox  
*Assistant Examiner* — Messina L Smith  
(74) *Attorney, Agent, or Firm* — Ryan Kromholz &  
Manion, S.C.

(57) **CLAIM**  
The ornamental design for an induction warmer, as shown  
and described.

**DESCRIPTION**

FIG. 1 is a perspective view of a first embodiment of an  
induction warmer, showing the new design;  
FIG. 2 is a right side elevation view thereof;  
FIG. 3 is a left side elevation view thereof;  
FIG. 4 is a front elevation view thereof;  
FIG. 5 is a rear elevation view thereof;  
FIG. 6 is a top plan view thereof;  
FIG. 7 is a bottom plan view thereof;  
FIG. 8 is a perspective view of a second embodiment of the  
induction warmer;  
FIG. 9 is a right side elevation view thereof;  
FIG. 10 is a left side elevation view thereof;  
FIG. 11 is a front elevation view thereof;  
FIG. 12 is a rear elevation view thereof;  
FIG. 13 is a top plan view thereof;  
FIG. 14 is a bottom plan view thereof;  
FIG. 15 is a perspective view of a third embodiment of the  
induction warmer;  
FIG. 16 is a right side elevation view thereof;  
FIG. 17 is a left side elevation view thereof;  
FIG. 18 is a front elevation view thereof;  
FIG. 19 is a rear elevation view thereof;  
FIG. 20 is a top plan view thereof; and,  
FIG. 21 is a bottom plan view thereof.

The broken lines in the drawings depict portions of the  
induction warmer that form no part of the claimed design.

**1 Claim, 6 Drawing Sheets**

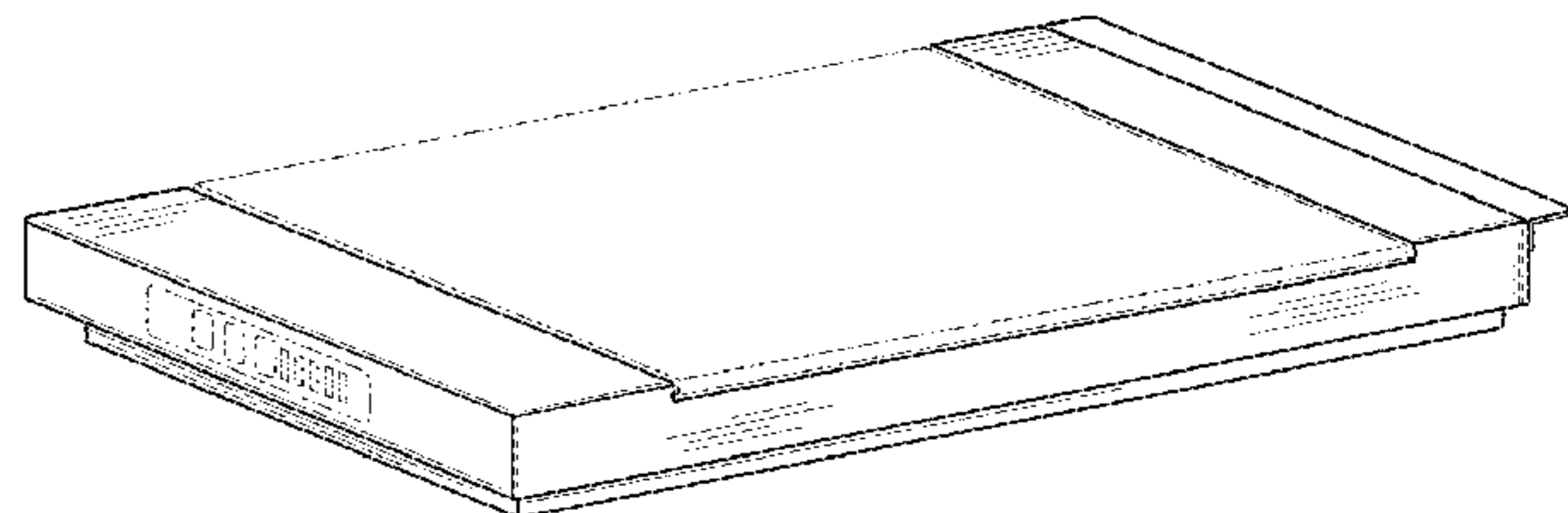
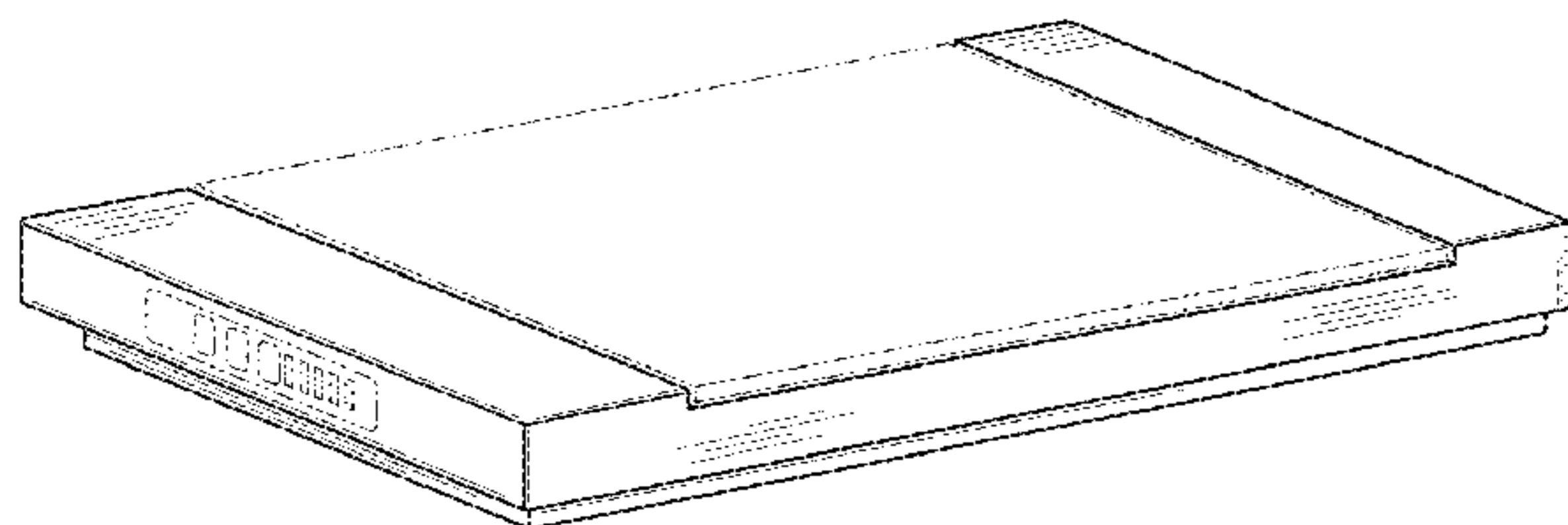

(56)

**References Cited**

U.S. PATENT DOCUMENTS

D751,855 S	*	3/2016	Bassill .....	D7/367
D793,801 S	*	8/2017	Bassill .....	D7/362
D814,848 S	*	4/2018	Bassill .....	D7/367
D817,704 S	*	5/2018	Kim .....	D7/402
D817,710 S	*	5/2018	Kim .....	D7/409

\* cited by examiner

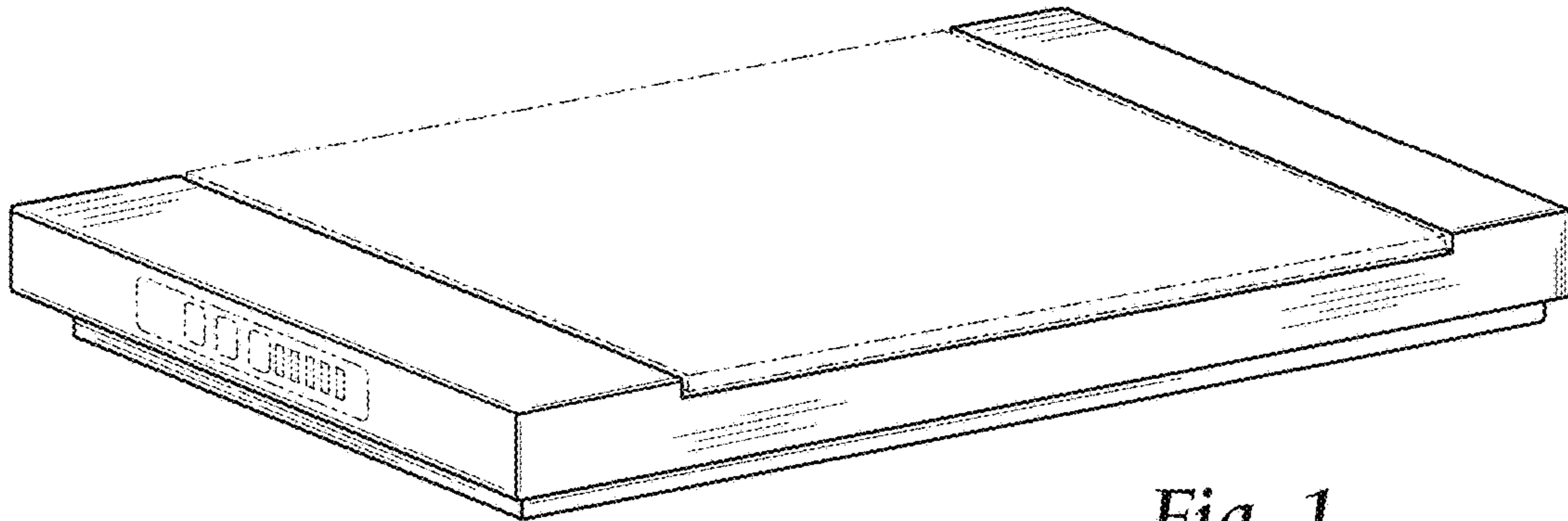

*Fig. 1*

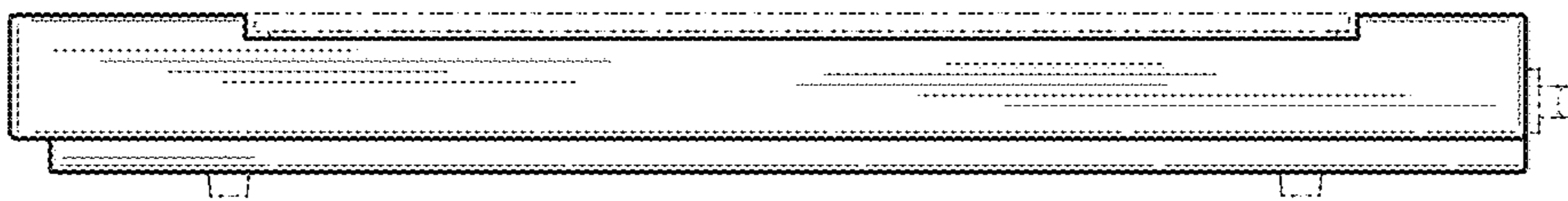

*Fig. 2*

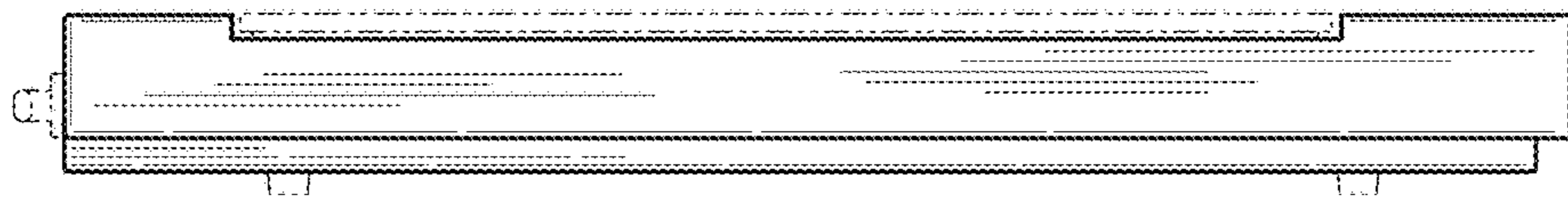

*Fig. 3*

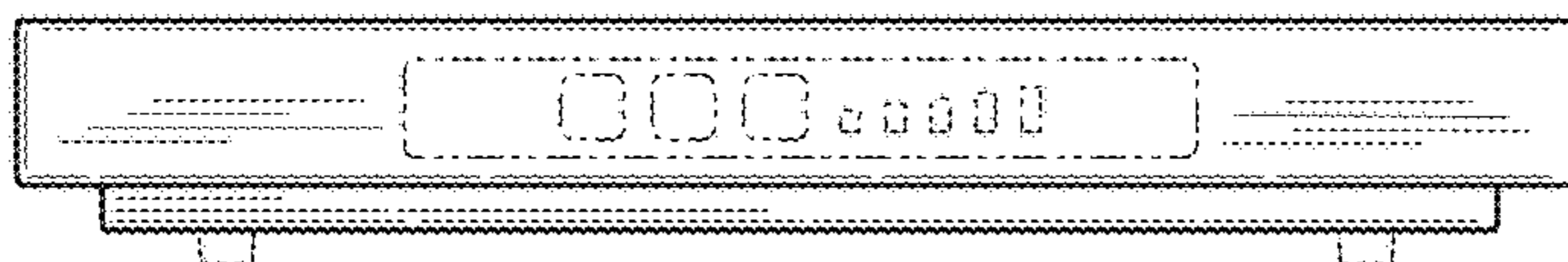

*Fig. 4*

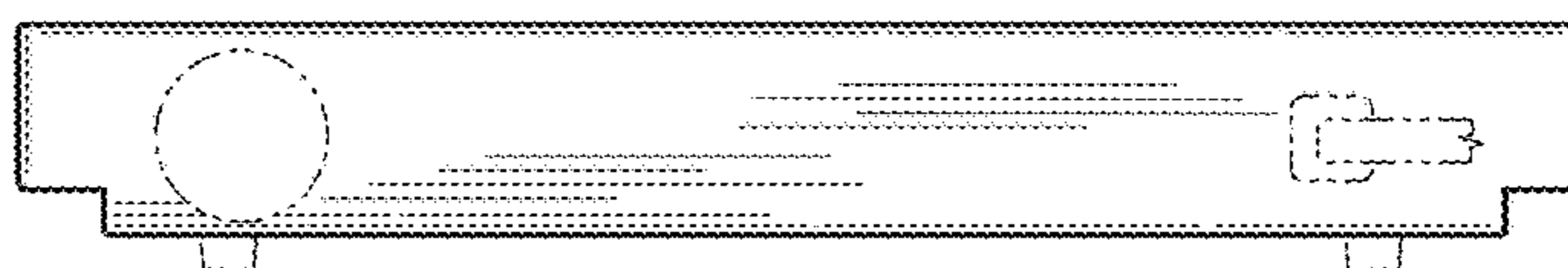

*Fig. 5*

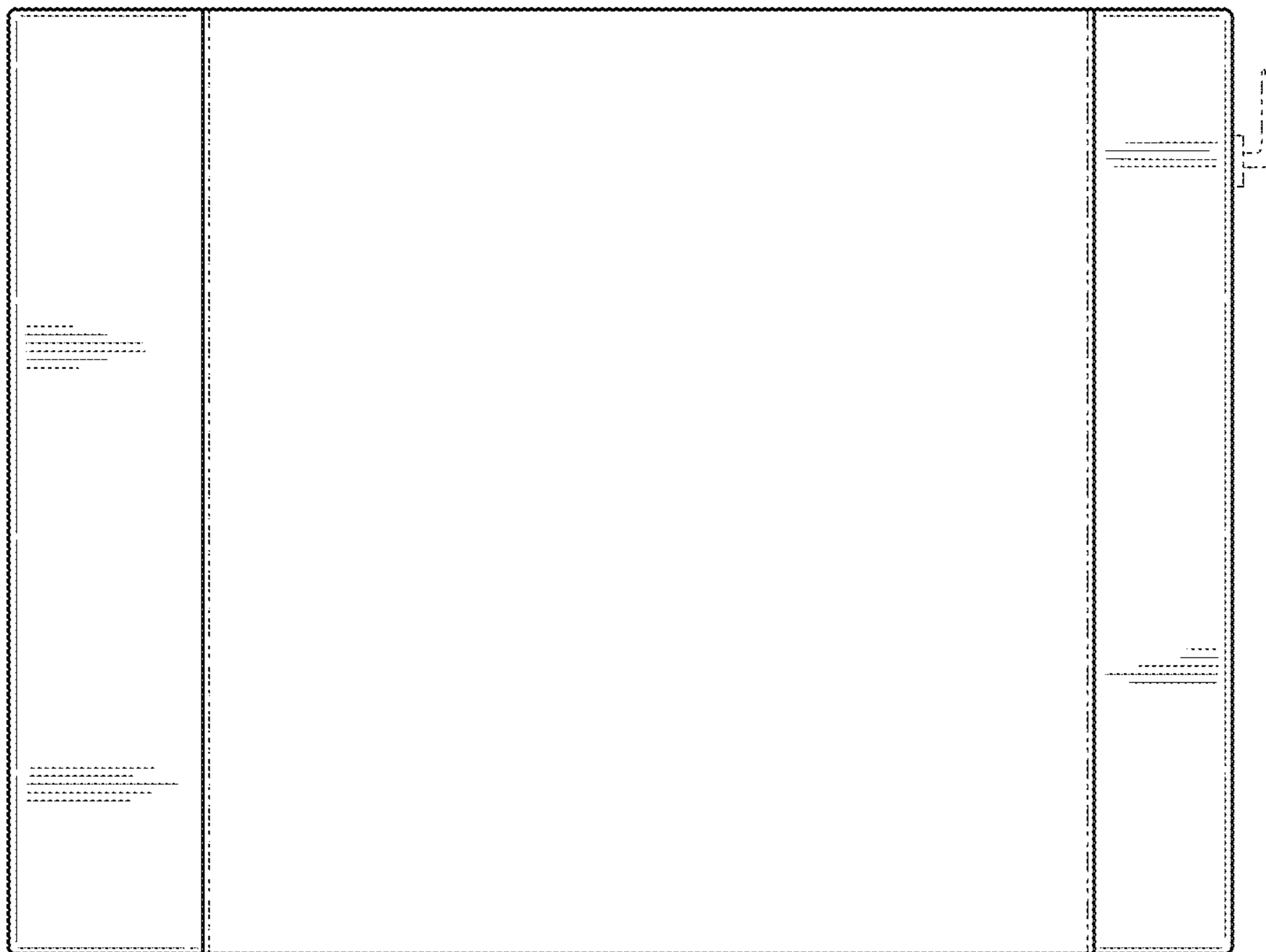

*Fig. 6*

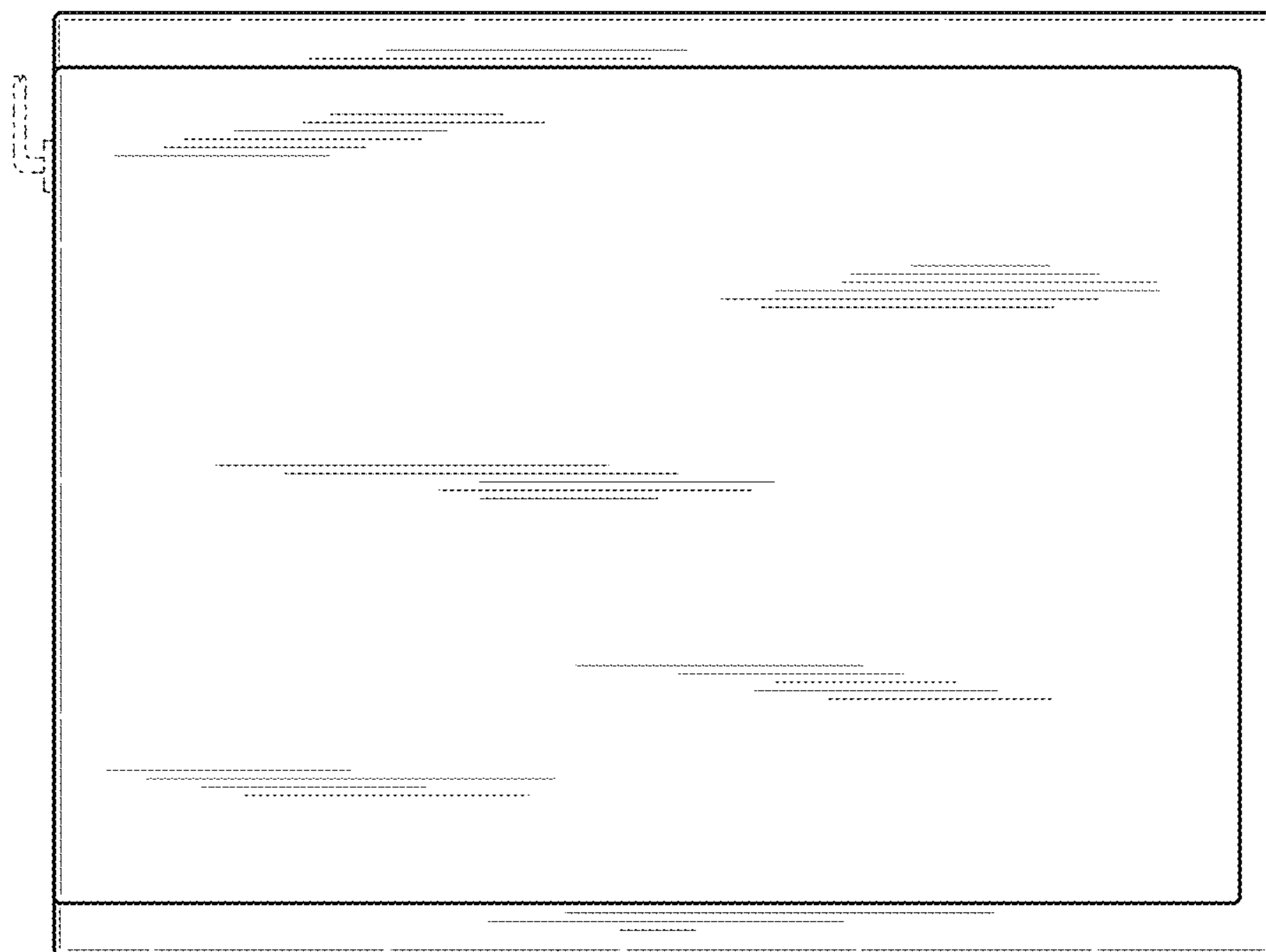

*Fig. 7*

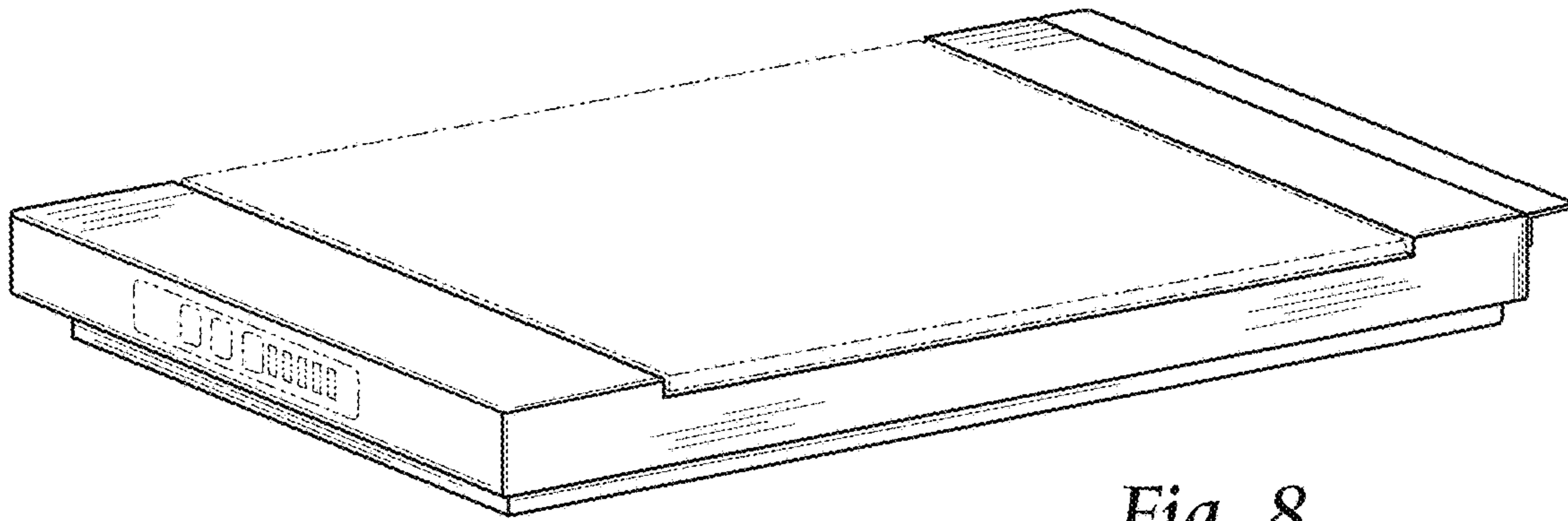

*Fig. 8*

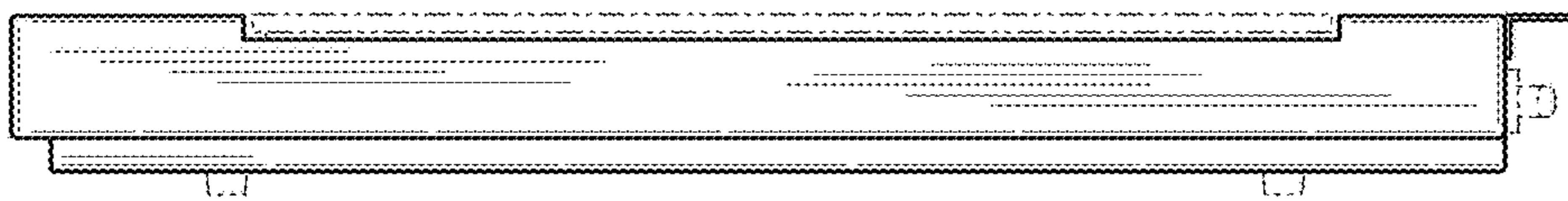

*Fig. 9*

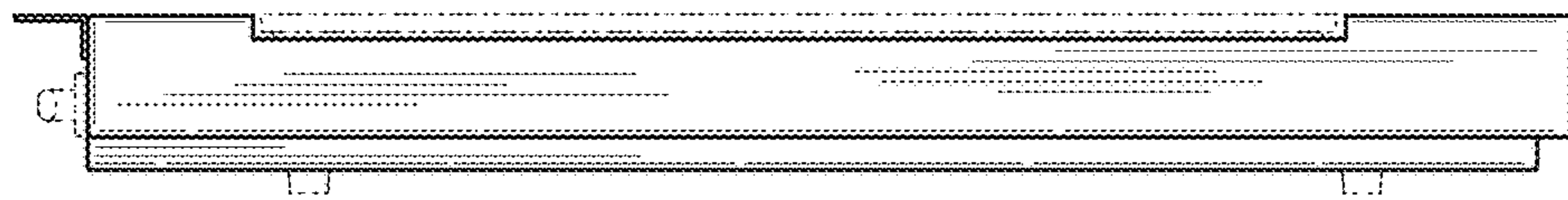

*Fig. 10*

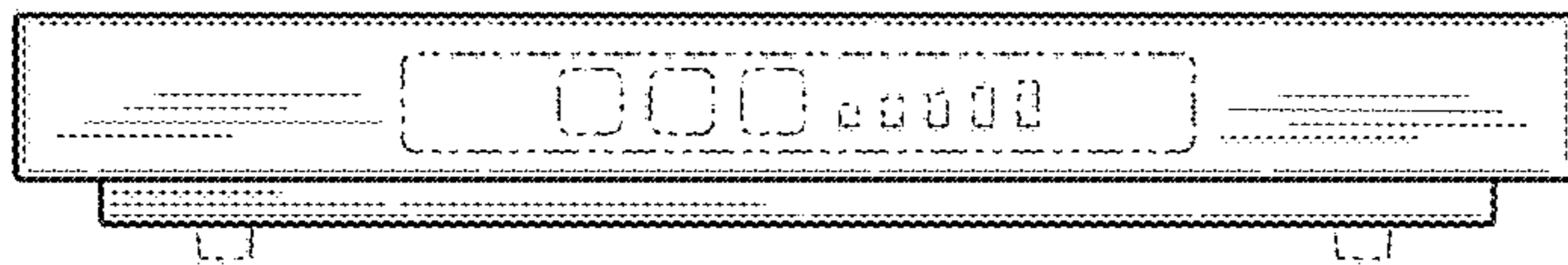

*Fig. 11*

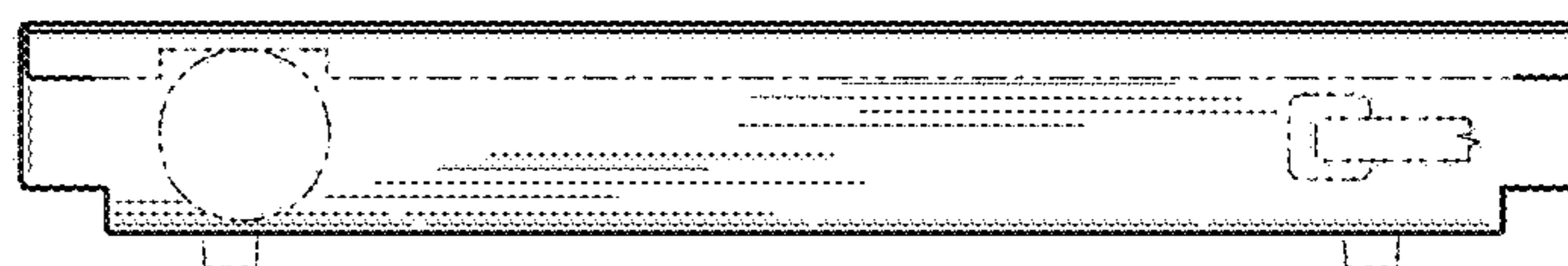

*Fig. 12*

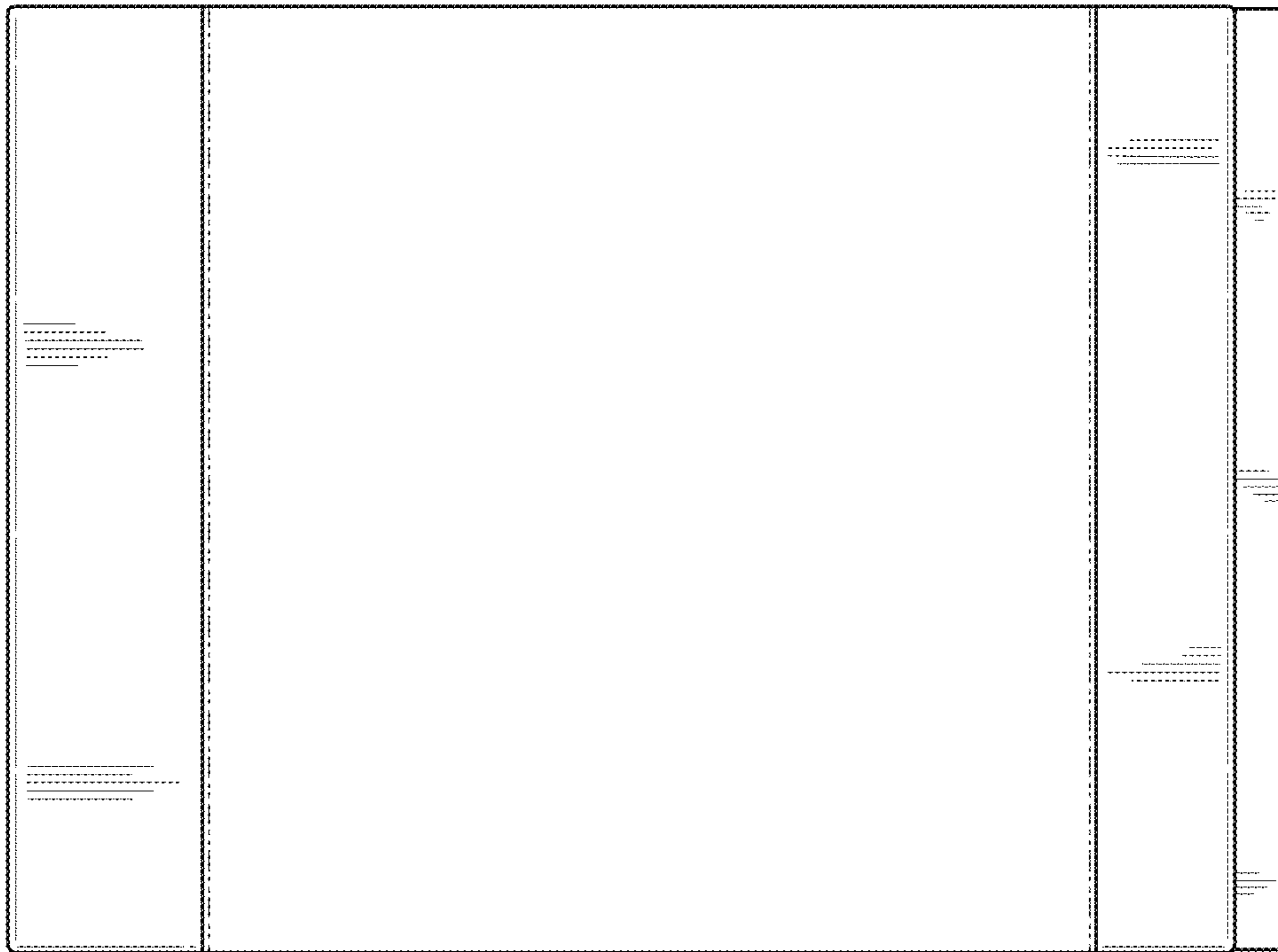

*Fig. 13*

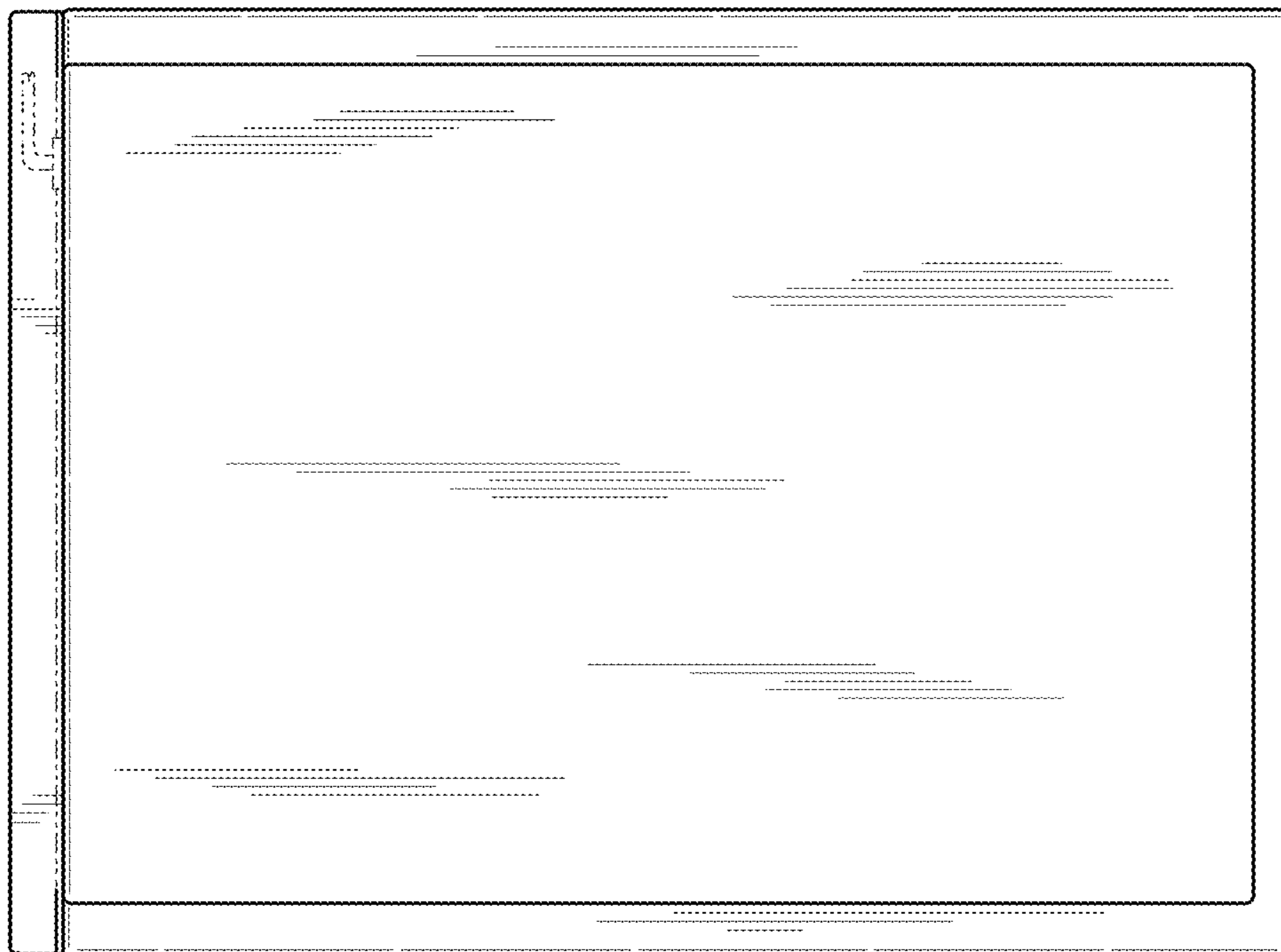

*Fig. 14*

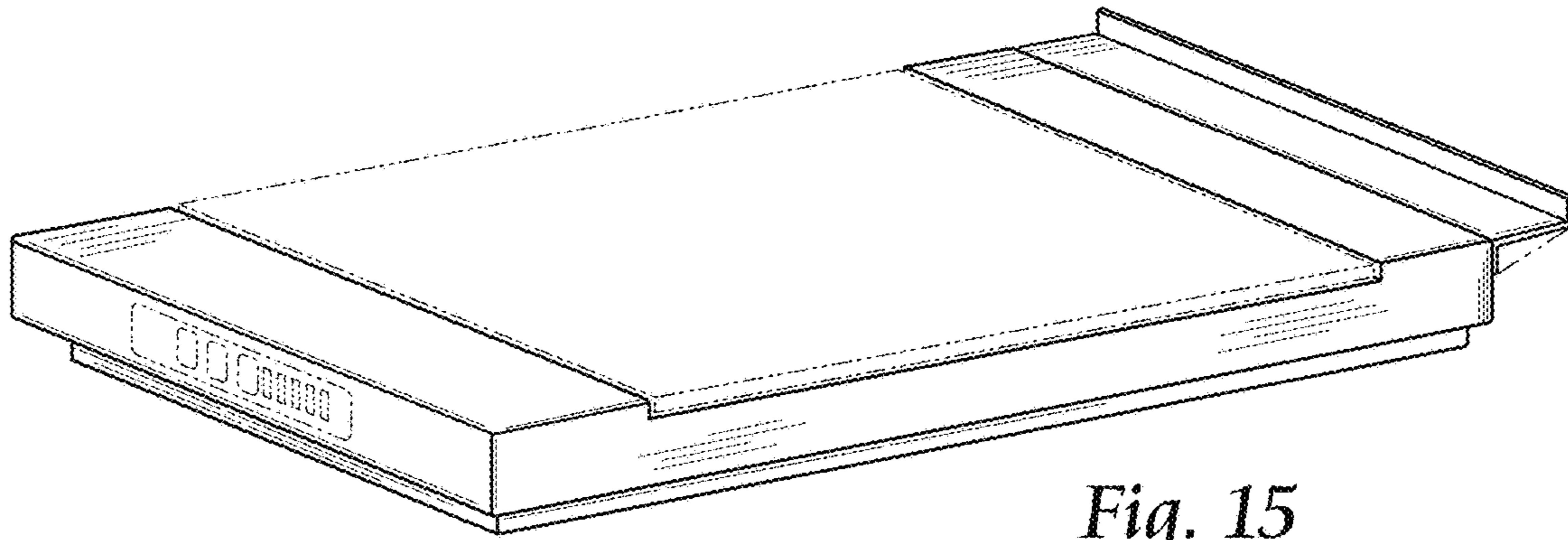

*Fig. 15*

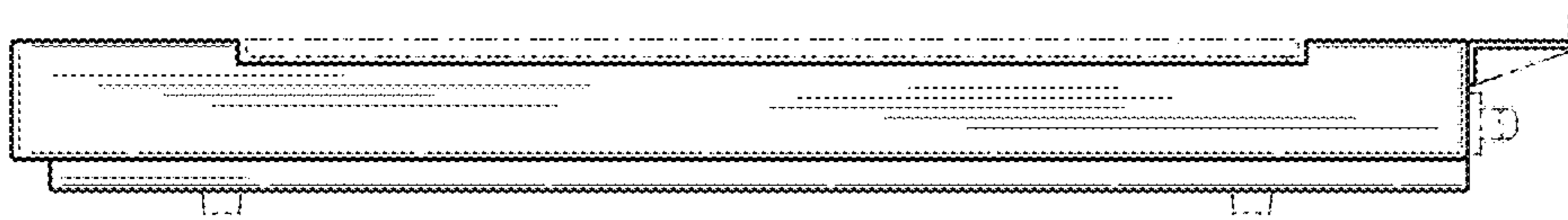

*Fig. 16*

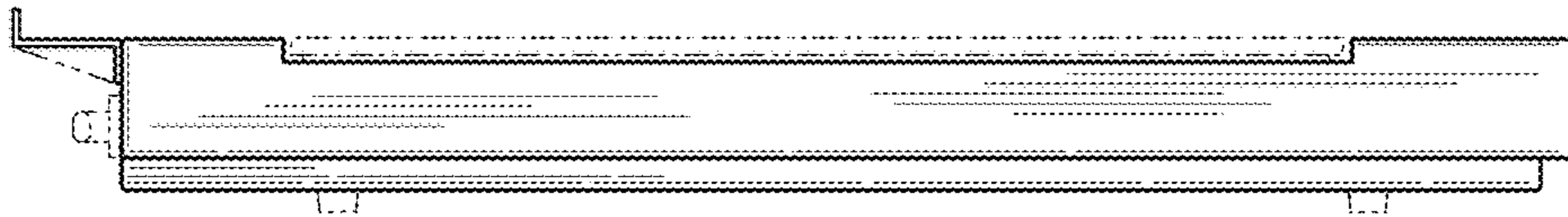

*Fig. 17*

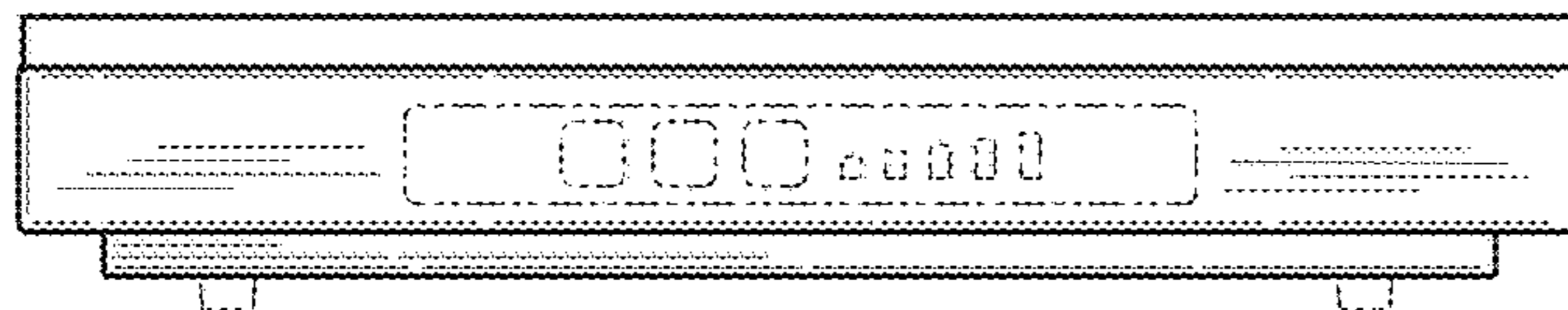

*Fig. 18*

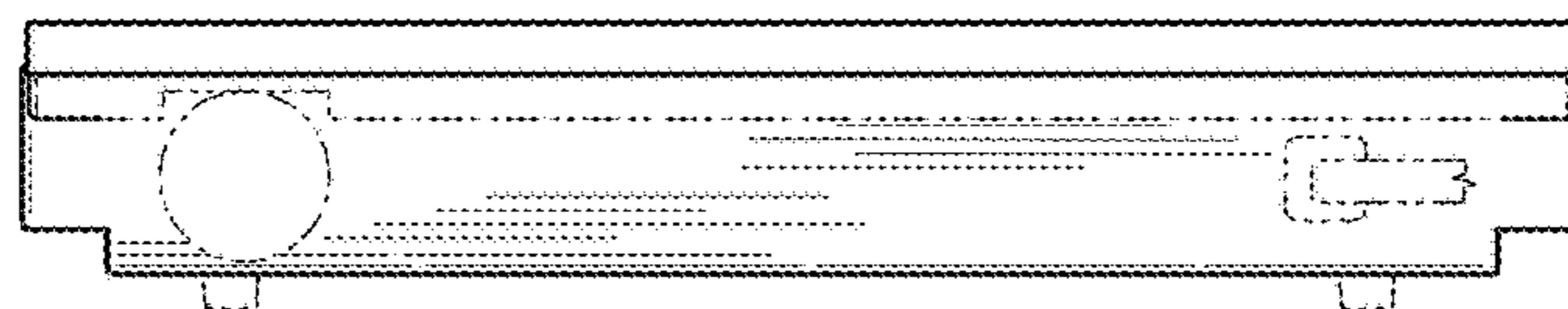

*Fig. 19*

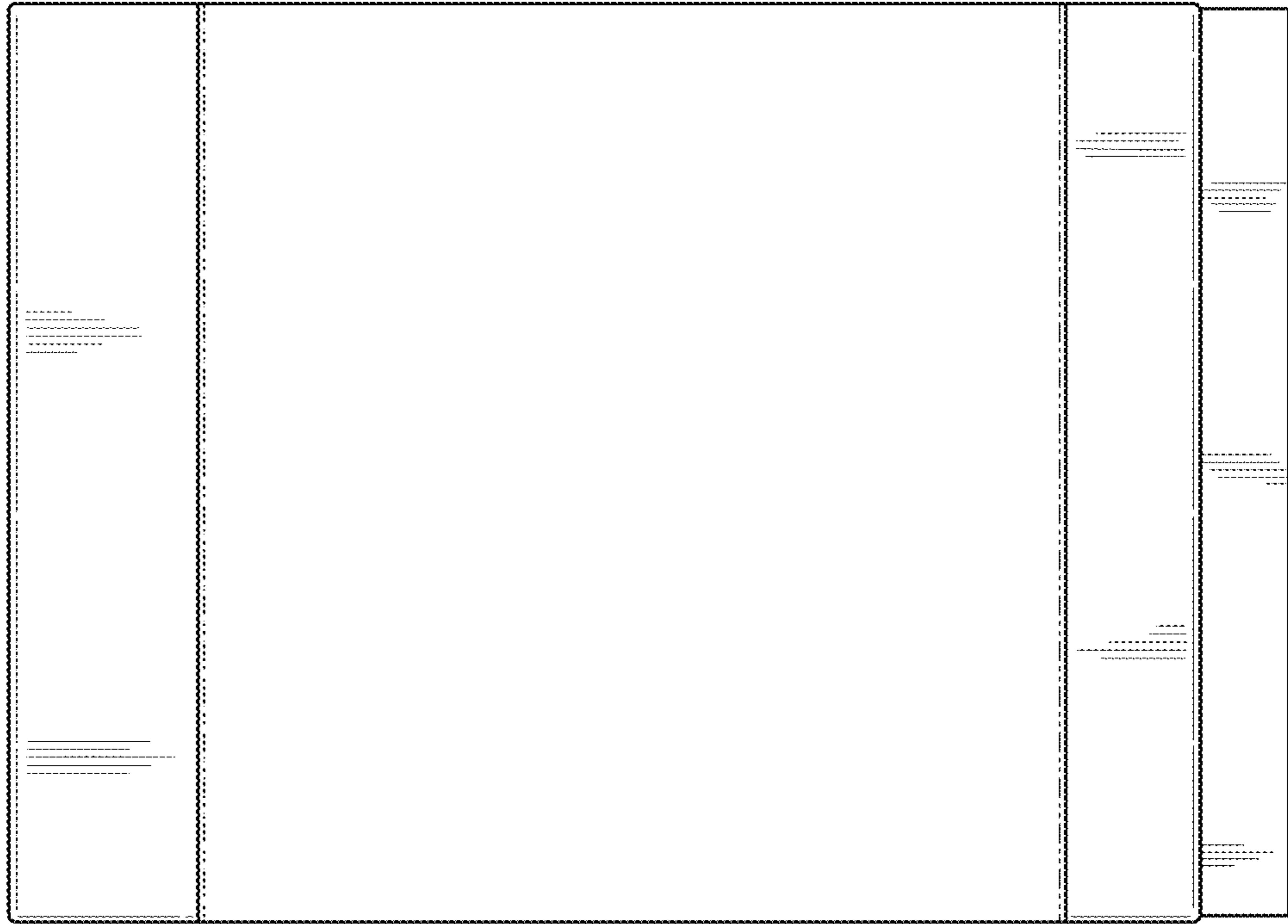

*Fig. 20*

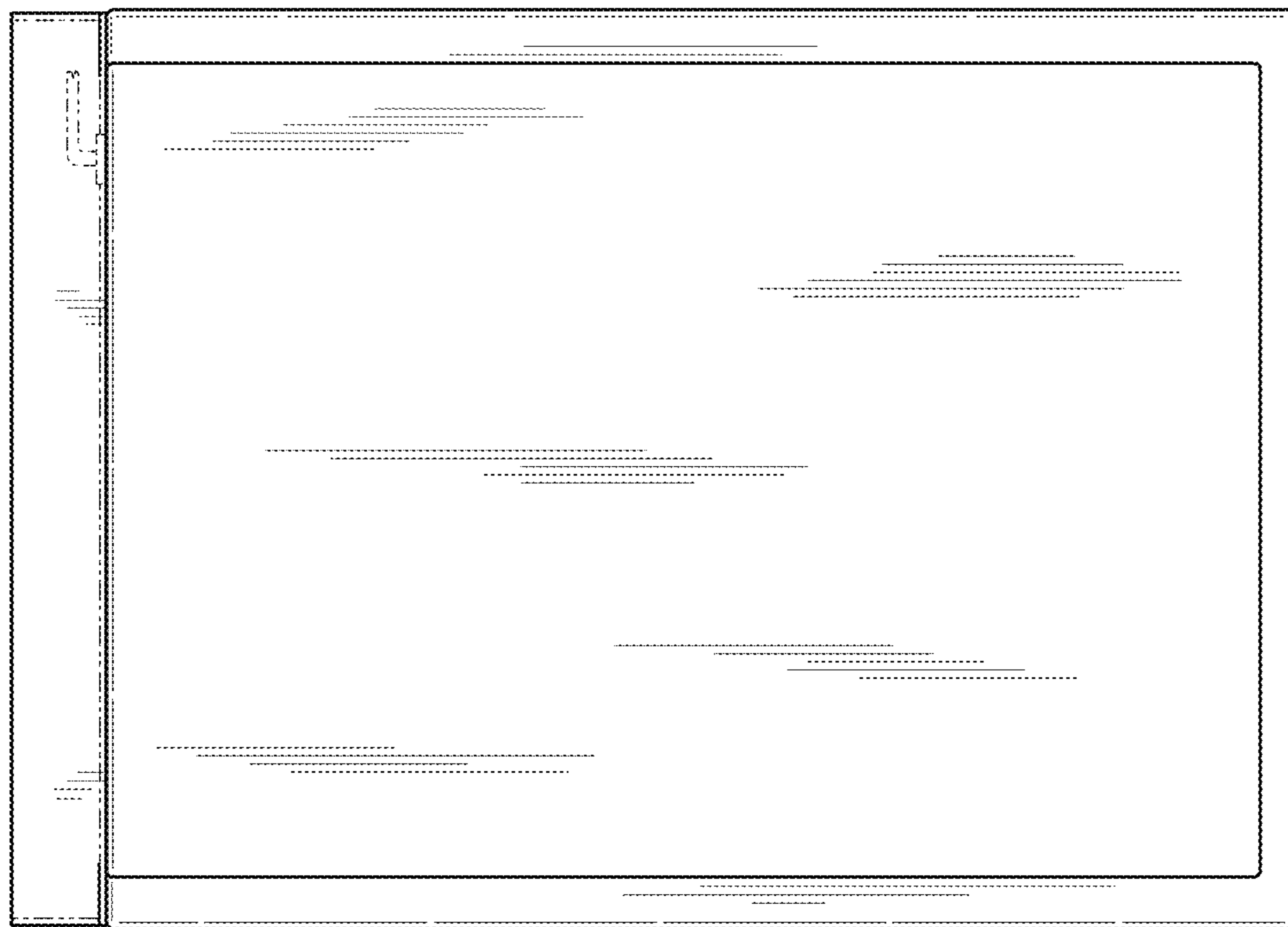

*Fig. 21*