



US00D852521S

(12) **United States Design Patent** (10) **Patent No.:** **US D852,521 S**
Clark et al. (45) **Date of Patent:** **** Jul. 2, 2019**

(54) **HANGER**

(71) Applicant: **TARGET BRANDS, INC.**,
Minneapolis, MN (US)
(72) Inventors: **Jeremy A. Clark**, Minneapolis, MN
(US); **Terrence J. Hornsby, Jr.**,
Minneapolis, MN (US); **Richard P.**
Riedel, Blaine, MN (US); **Timothy**
James Martell, Minneapolis, MN (US)
(73) Assignee: **TARGET BRANDS, INC.**,
Minneapolis, MN (US)

(**) Term: **15 Years**

(21) Appl. No.: **29/637,749**

(22) Filed: **Feb. 21, 2018**

(51) **LOC (11) Cl.** **06-08**

(52) **U.S. Cl.**
USPC **D6/326**; D6/318; D6/328

(58) **Field of Classification Search**
USPC D6/315–328
CPC A47G 25/26; A47G 25/28; A47G 25/30;
A47G 25/32; A47G 25/34; A47G 25/36;
A47G 25/38; A47G 25/442; A47G
25/625; A47G 25/743; A47G 25/1407;
A47G 25/1457; A47G 2025/1492; A47F
7/18; A47F 7/19; A47F 7/22
See application file for complete search history.

(56) **References Cited**

U.S. PATENT DOCUMENTS

890,023 A 6/1908 Cazier et al.
2,171,680 A 9/1939 Baugh
2,419,723 A 4/1947 Mack, Sr.
2,723,787 A 11/1955 Bransdorf

(Continued)

FOREIGN PATENT DOCUMENTS

EP 1512352 B1 8/2013

OTHER PUBLICATIONS

“Velvet Flocked Hanger”, printed from www.dhgate.com/product/flocked-hanger-with-good-quality-druable/138480211.html, publicly available at least as early as Jan. 18, 2017 (3 pages).
“Lingerie, Bra & Panty, Swimwear 10" Flexible Plastic Retail Hangers”, printed from www.alibaba.com/product-detail/Lingerie-Bra-Panty-Swimwear-10-Flexible_520783895.htm, publicly available at least as early as Dec. 20, 2017 (4 pages).

(Continued)

Primary Examiner — Lauren R Calve

(74) *Attorney, Agent, or Firm* — JoAnn M. Seaton;
Griffiths & Seaton PLLC

(57) **CLAIM**

The ornamental design for a hanger, as shown and described.

DESCRIPTION

FIG. 1 is a front, top perspective view of a hanger showing an embodiment of our new design;
FIG. 2 is a rear, top perspective view thereof;
FIG. 3 is a front view thereof;
FIG. 4 is a rear view thereof;
FIG. 5 is a right side view thereof;
FIG. 6 is a left side view thereof;
FIG. 7 is a top view thereof; and
FIG. 8 is a bottom view thereof.
FIG. 9 is a front, top perspective view of a hanger showing an embodiment of our new design;
FIG. 10 is a rear, top perspective view thereof;
FIG. 11 is a front view thereof;
FIG. 12 is a rear view thereof;
FIG. 13 is a right side view thereof;
FIG. 14 is a left side view thereof;
FIG. 15 is a top view thereof; and,
FIG. 16 is a bottom view thereof.

The features shown in broken lines are portions of the hanger forming no part of the claimed design. The features shown in long dash-short dash bolded broken lines indicate the bounds of the claimed design and otherwise form no part of the claimed design.

1 Claim, 9 Drawing Sheets

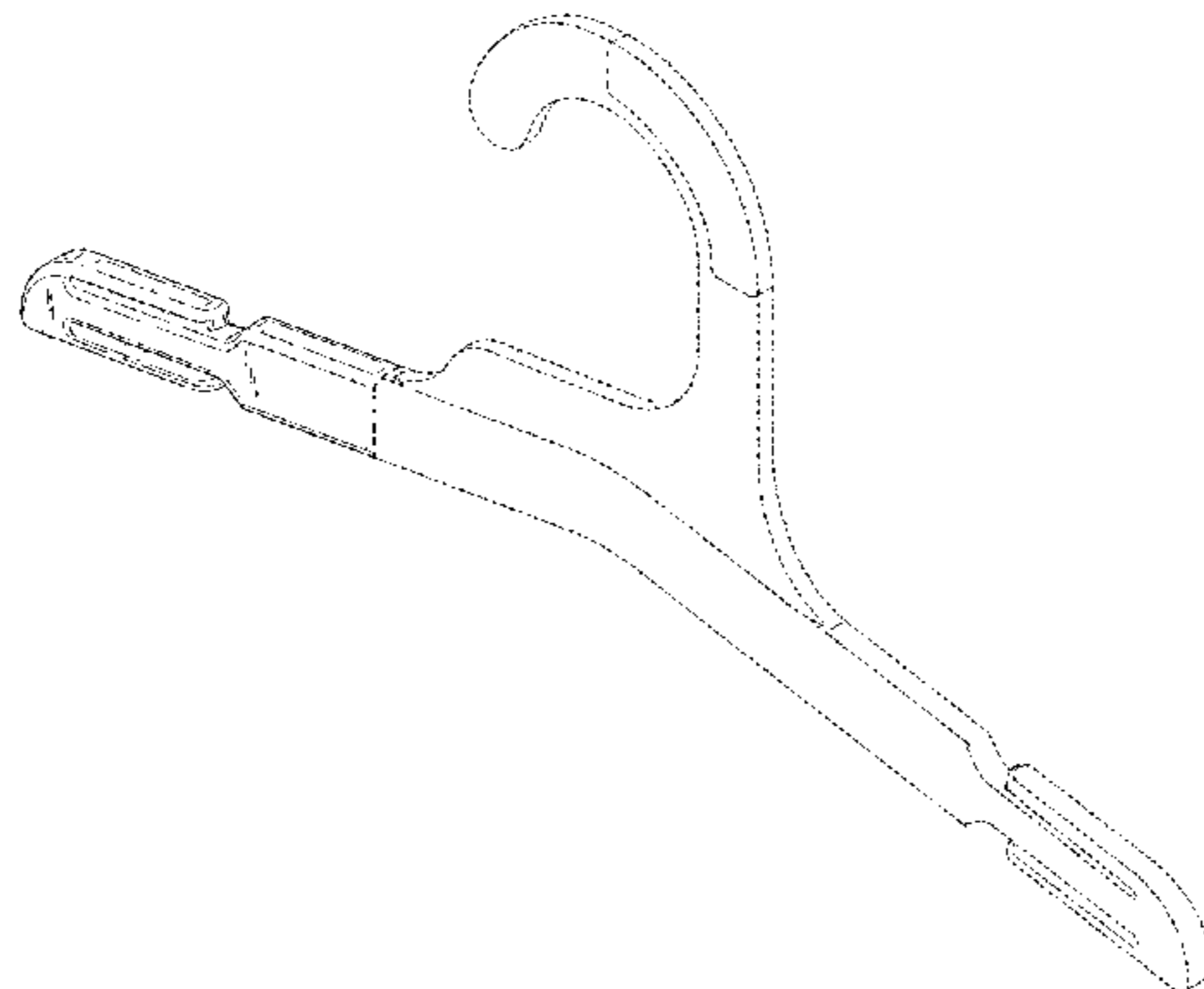

(56)

References Cited

U.S. PATENT DOCUMENTS

2,835,422 A 5/1958 Stuard
 3,085,724 A 4/1963 Wilde
 3,209,966 A 10/1965 Wach
 D206,199 S * 11/1966 Zuckerman 223/92
 3,559,852 A 2/1971 Green
 3,731,857 A 5/1973 Haggar
 D264,912 S 6/1982 Bliss et al.
 D265,156 S 6/1982 Bisk et al.
 4,438,874 A * 3/1984 Zuckerman A47G 25/16
 223/88
 4,623,079 A 11/1986 Tendrup et al.
 4,828,155 A 5/1989 Louw
 D302,214 S 7/1989 Wilson
 D303,325 S 9/1989 Marshall
 4,895,283 A 1/1990 Evangelist et al.
 5,065,916 A 11/1991 Fildan
 5,069,373 A 12/1991 Kolton et al.
 5,071,045 A 12/1991 Hollis
 5,074,445 A 12/1991 Chen
 5,083,691 A 1/1992 Handrick
 D324,313 S * 3/1992 Kolton D6/318
 D327,580 S 7/1992 Fildan
 D327,581 S 7/1992 Fildan
 5,127,559 A * 7/1992 Freer A47G 25/1407
 223/85
 5,129,557 A 7/1992 Kolton et al.
 D329,754 S 9/1992 Gouldson et al.
 D329,755 S 9/1992 Gouldson
 D335,581 S * 5/1993 Gouldson D6/315
 5,236,109 A 8/1993 Zuckerman
 D340,138 S 10/1993 Gouldson
 D348,987 S 7/1994 Gouldson et al.
 D350,236 S 9/1994 Gouldson et al.
 5,361,949 A 11/1994 Petrou
 D353,945 S 1/1995 Louw
 D368,376 S 4/1996 Gouldson et al.
 D371,246 S 7/1996 Gouldson et al.
 5,573,151 A 11/1996 Fildan
 5,632,423 A 5/1997 Louw
 D381,814 S 8/1997 Louw
 D387,912 S 12/1997 Fildan
 D388,620 S 1/1998 Gouldson et al.
 D388,964 S 1/1998 Gouldson
 D390,015 S 2/1998 Gouldson
 D392,113 S 3/1998 Gouldson
 5,806,728 A 9/1998 Forsstrom et al.
 D413,446 S 9/1999 Gouldson
 D414,044 S * 9/1999 Choi D6/318
 D414,946 S 10/1999 Gouldson
 6,065,652 A 5/2000 Dooling-Sherman
 6,070,772 A 6/2000 Bond
 6,079,598 A 6/2000 Tsai
 6,105,835 A 8/2000 Hatakeyama
 6,142,347 A 11/2000 Kolton et al.
 6,158,635 A 12/2000 Batts
 D435,973 S 1/2001 Gouldson
 6,173,872 B1 1/2001 Cohen
 6,196,430 B1 3/2001 Gouldson
 6,250,523 B1 6/2001 Louw
 6,338,426 B1 1/2002 Okiyama
 D453,423 S 2/2002 Goldman et al.
 6,357,638 B2 3/2002 Gouldson
 6,435,387 B1 8/2002 Gouldson et al.
 6,457,615 B1 10/2002 Lam
 6,467,658 B1 10/2002 Olk et al.
 6,467,659 B2 10/2002 Gouldson
 6,499,634 B2 12/2002 Olk et al.
 6,516,980 B1 2/2003 Goldman
 6,588,634 B2 7/2003 Gouldson et al.
 6,688,503 B2 2/2004 Viazanko et al.
 6,715,650 B2 4/2004 Gouldson
 D500,412 S 1/2005 Gouldson
 D502,606 S * 3/2005 Gouldson D6/326
 6,892,910 B2 5/2005 Capuano et al.
 D507,419 S 7/2005 Gouldson

7,118,014 B2 10/2006 Ali et al.
 7,156,271 B2 1/2007 Louw
 D559,562 S 1/2008 Jones
 7,398,902 B1 7/2008 Sutton
 D598,206 S 8/2009 Gouldson
 D606,764 S 12/2009 Warren
 D606,765 S 12/2009 Warren
 D606,766 S 12/2009 Warren
 D606,767 S 12/2009 Warren
 D607,216 S 1/2010 Niccol
 D607,217 S 1/2010 Warren
 D607,218 S 1/2010 Warren
 D628,818 S 12/2010 Warren
 D628,820 S 12/2010 Warren
 D628,821 S 12/2010 Warren
 D628,822 S 12/2010 Warren
 7,896,204 B2 3/2011 Gouldson
 7,938,300 B2 5/2011 Diamond et al.
 7,980,434 B2 7/2011 Gouldson
 D646,064 S * 10/2011 Jones D6/326
 D653,042 S * 1/2012 Gouldson D6/315
 8,302,826 B2 11/2012 Gouldson
 D711,659 S 8/2014 Gouldson
 D716,062 S 10/2014 Gouldson
 8,991,666 B2 3/2015 Mazyck
 9,027,804 B2 5/2015 Barre et al.
 9,282,839 B2 3/2016 Rakhimimov et al.
 D761,028 S * 7/2016 Choy D6/326
 9,386,873 B2 7/2016 Gouldson
 9,510,702 B2 12/2016 Yau
 D816,351 S * 5/2018 Clark D6/318
 D826,582 S * 8/2018 Clark D6/318
 D831,987 S * 10/2018 Clark D6/326
 D832,600 S * 11/2018 Clark D6/326
 D843,741 S * 3/2019 Clark D6/318
 2001/0015361 A1 8/2001 Gouldson
 2001/0016994 A1 8/2001 Gouldson et al.
 2002/0108975 A1 8/2002 Hunt et al.
 2002/0113100 A1 8/2002 Gouldson
 2003/0015558 A1 1/2003 Gouldson et al.
 2003/0141374 A1 * 7/2003 Matkovich A47G 25/1407
 235/487
 2003/0183665 A1 10/2003 Olk et al.
 2004/0173646 A1 9/2004 Louw
 2004/0222254 A1 11/2004 Olk et al.
 2004/0256425 A1 12/2004 Barre et al.
 2005/0067447 A1 3/2005 Louw
 2005/0269377 A1 12/2005 Ali et al.
 2007/0246490 A1 10/2007 Gouldson
 2008/0296324 A1 12/2008 Zhao et al.
 2009/0045232 A1 2/2009 Gray
 2009/0078726 A1 3/2009 Boulet et al.
 2010/0019005 A1 1/2010 Gouldson
 2010/0025440 A1 2/2010 Gouldson
 2010/0193553 A1 8/2010 Gouldson
 2010/0252588 A1 10/2010 Gouldson et al.
 2011/0057001 A1 3/2011 Louw
 2011/0284597 A1 11/2011 Kaleta et al.
 2017/0208979 A1 7/2017 Zuckerman et al.

OTHER PUBLICATIONS

“Black Plastic Bra & Swimwear Hangers 27 cm”, printed from www.hangerworld.com/sale/winterplastic/black-plastic-bra-swimwear-hanger-27cm.html, publicly available at least as early as Dec. 20, 2017 (4 pages).
 “Retail Plastic Bra Hangers Wholesale Underwear Hangers For Intimates”, printed from www.alibaba.com/product-detail/Retail-Plastic-Bra-Hangers-Wholesale-Underwear_60554522311.html, publicly available at least as early as Dec. 20, 2017 (7 pages).
 “Smartly Branded SmartWool® Bras—Fixtures Close Up”, printed from www.fixturescloseup.com/2014/03/01/smartly-branded-sports-bras/, publicly available at least as early as Mar. 1, 2014, per <http://webarchive.org> (14 pages).
 U.S. Appl. No. 29/603,830, filed May 12, 2017 (19 pages).

* cited by examiner

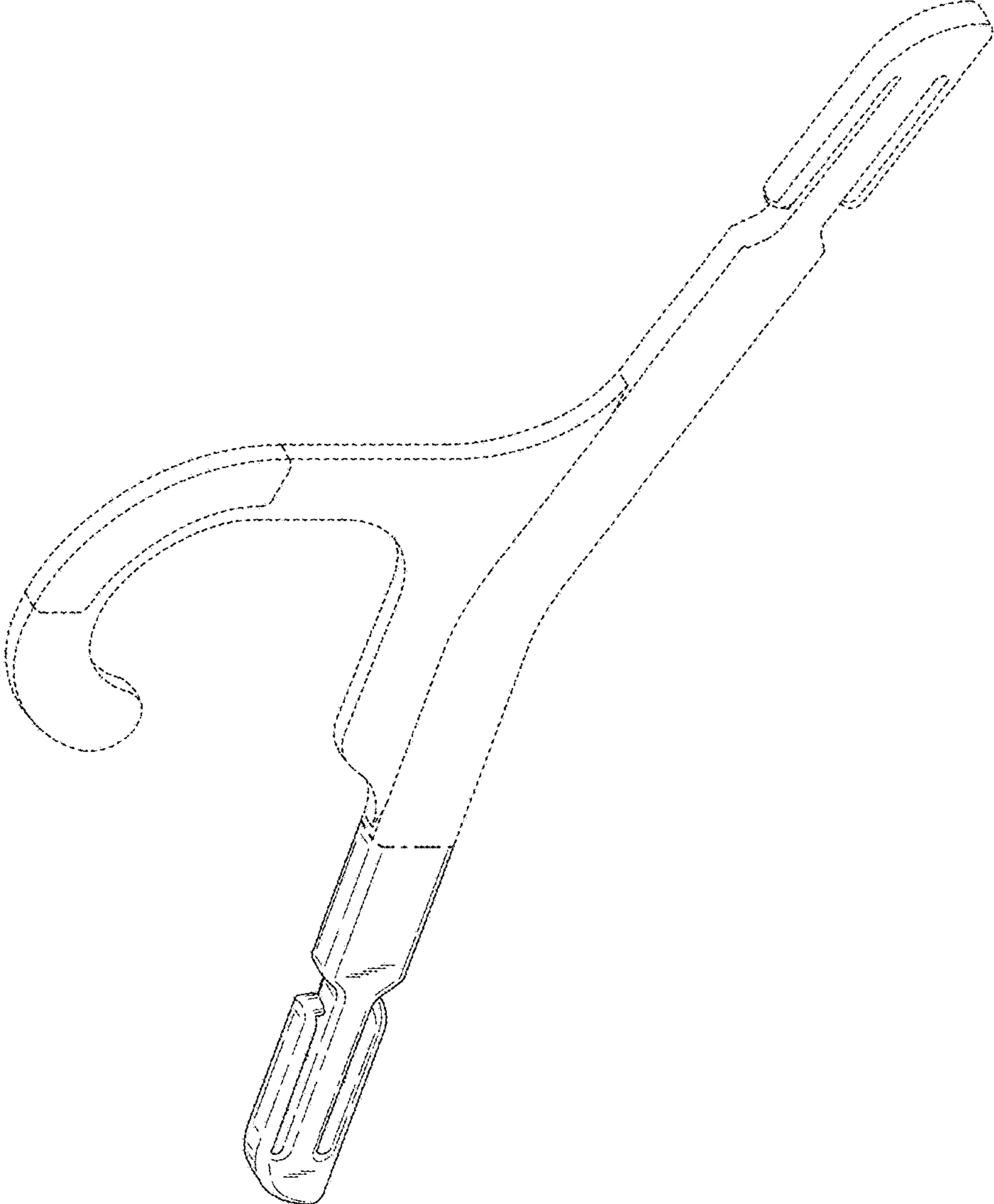

FIG. 1

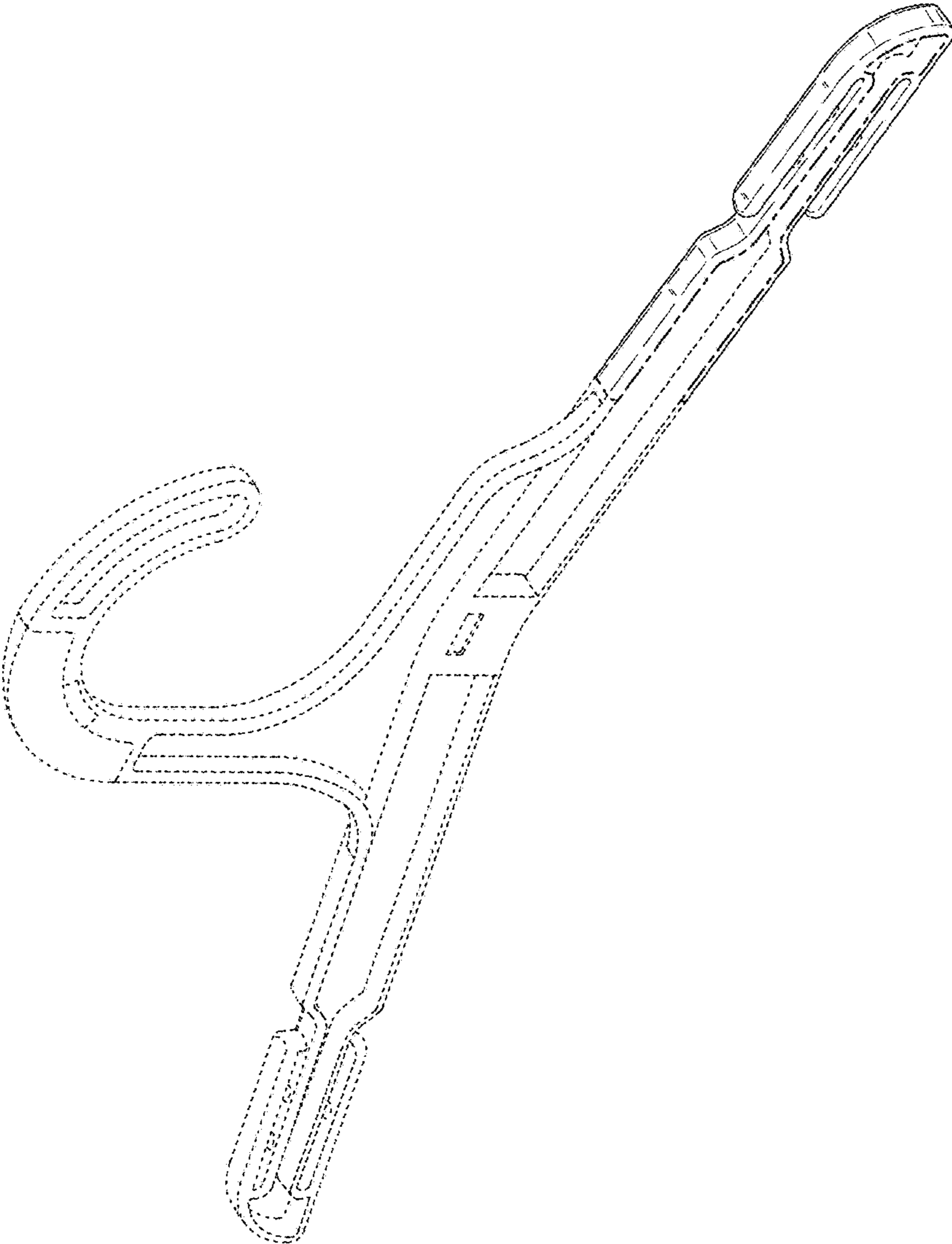

FIG. 2

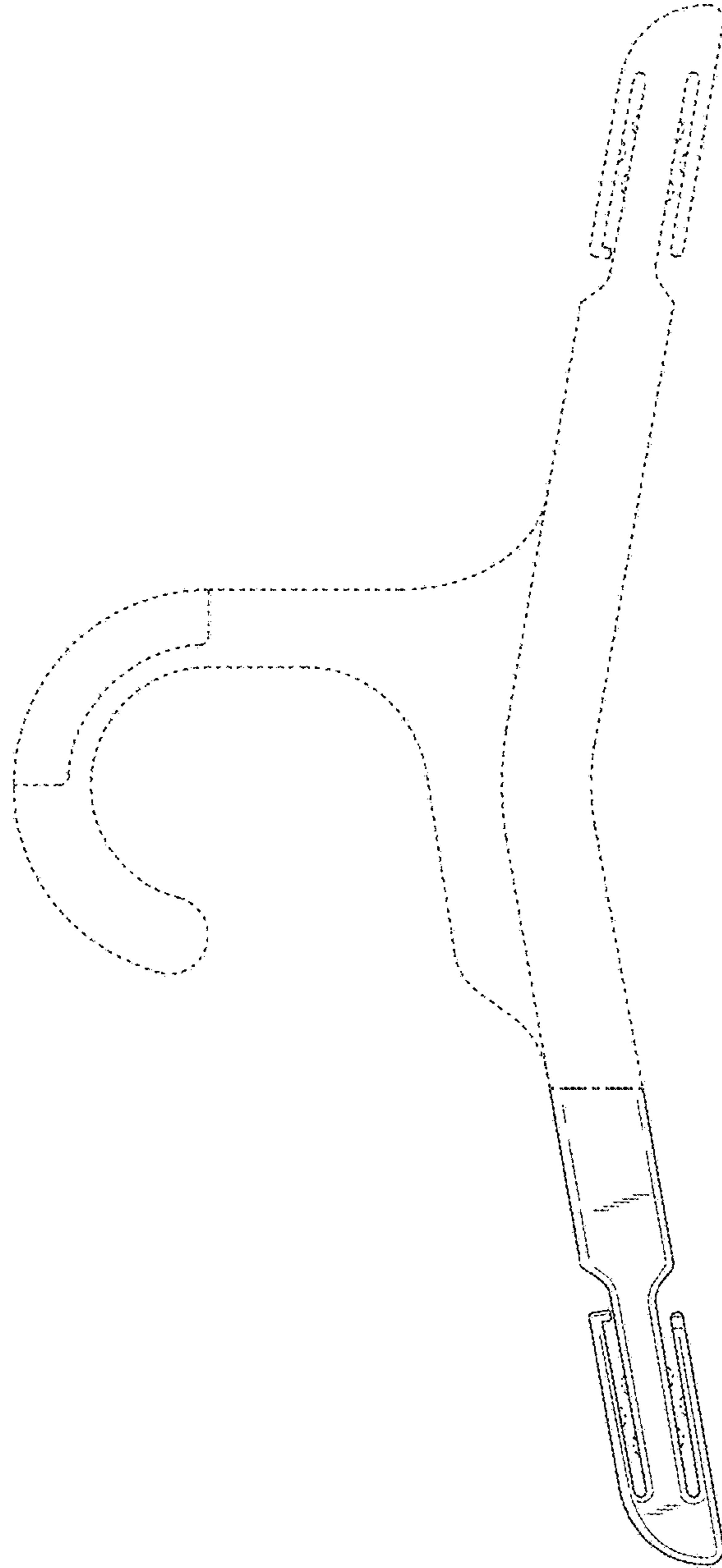

FIG. 3

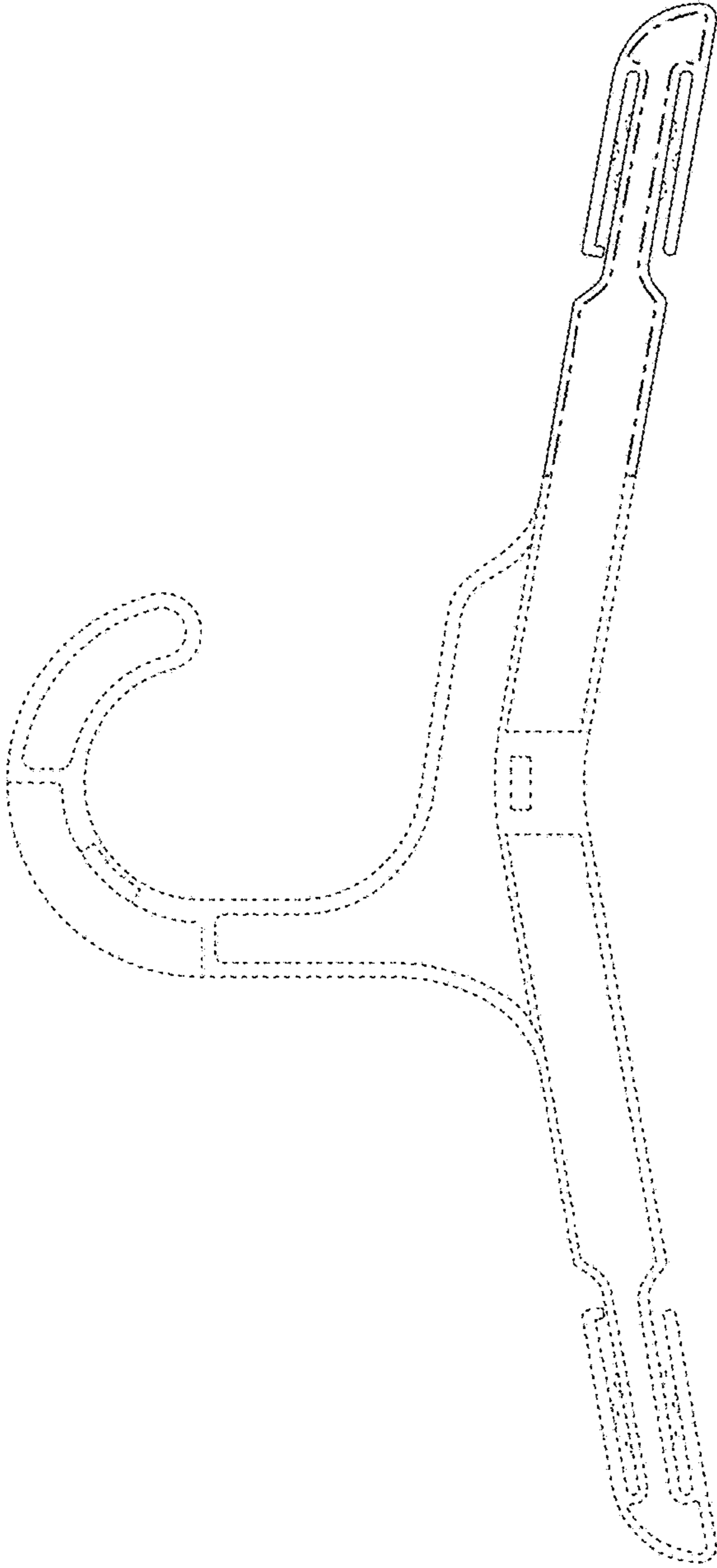

FIG. 4

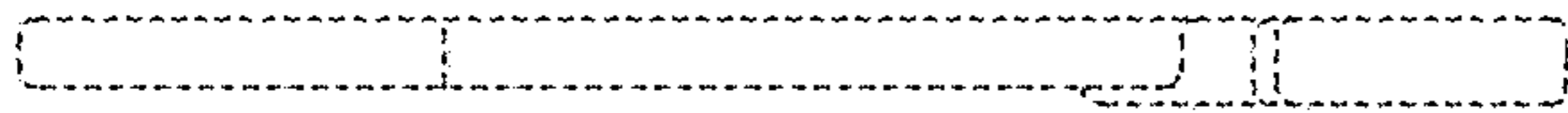

FIG. 5

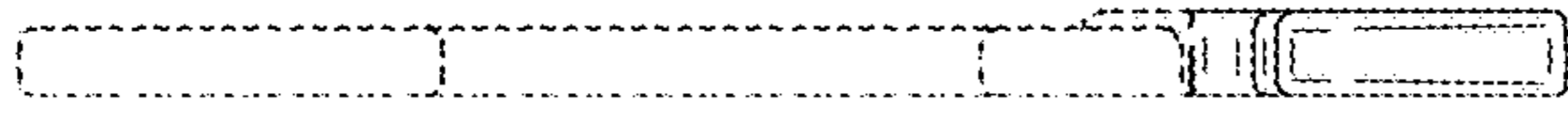

FIG. 6

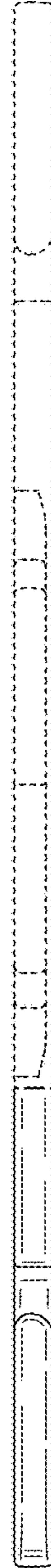

FIG. 7

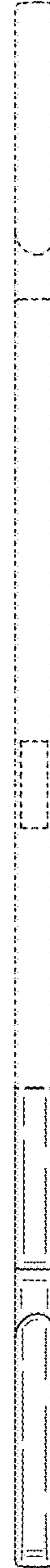

FIG. 8

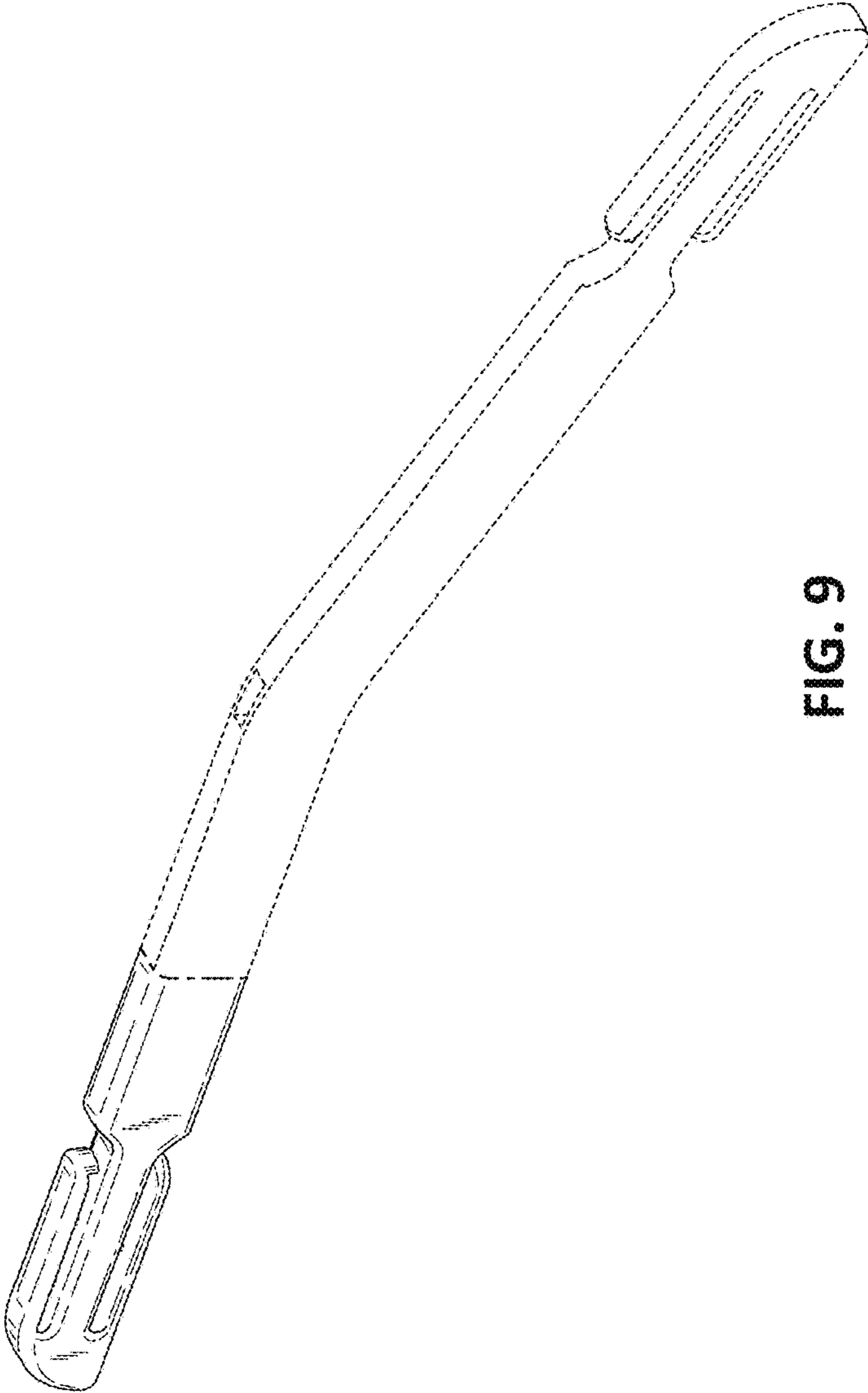

FIG. 9

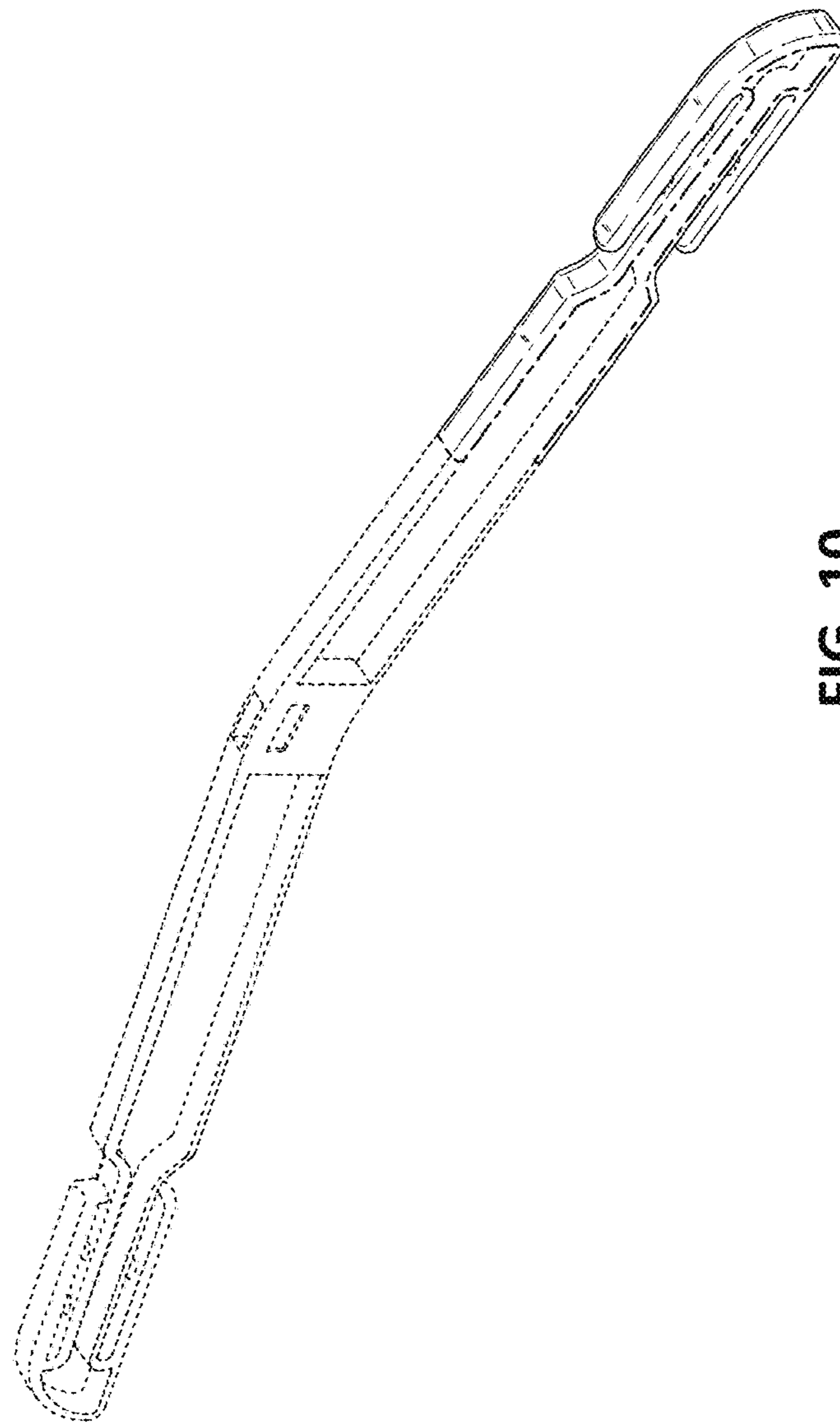

FIG. 10

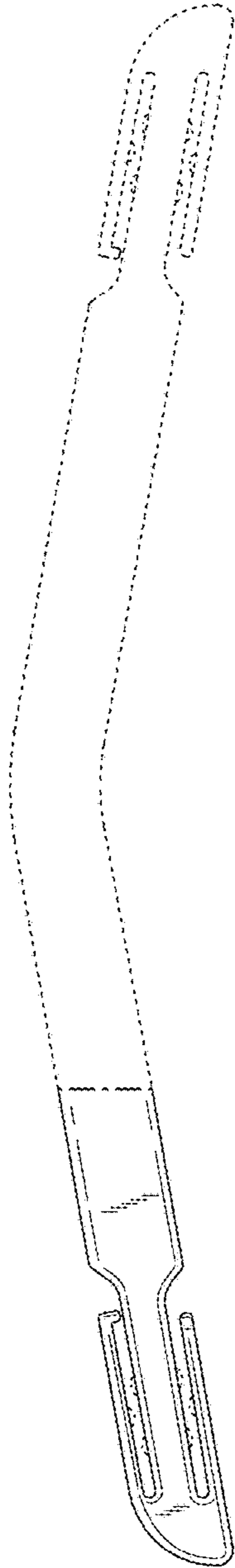

FIG. 11

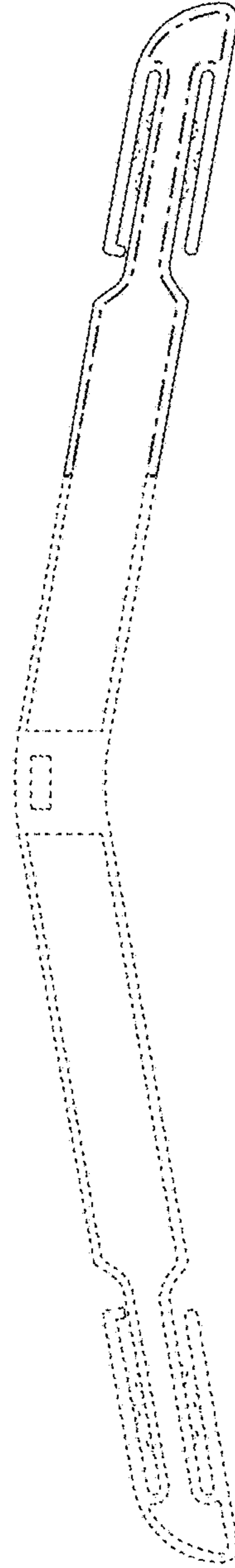

FIG. 12

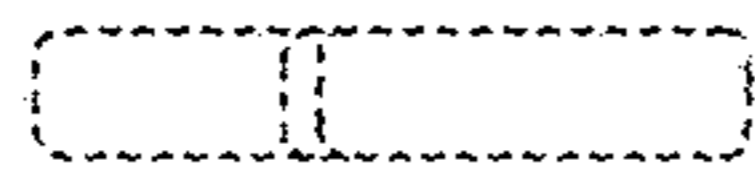

FIG. 13



FIG. 14

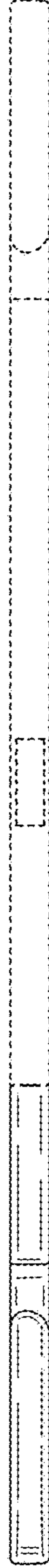

FIG. 15

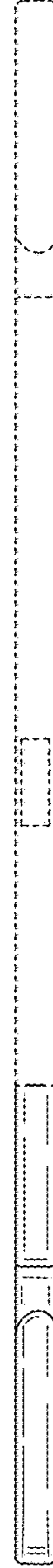

FIG. 16