



US00D852509S

(12) **United States Design Patent** (10) **Patent No.:** **US D852,509 S**
Zachar et al. (45) **Date of Patent:** **** Jul. 2, 2019**

(54) **TOOTHBRUSH ASSEMBLY**

D455,556 S * 4/2002 Kling D4/101
D474,894 S * 5/2003 Ferber D4/101
D475,529 S * 6/2003 Wright D4/101

(71) Applicant: **Airway Medix S.A.**, Warsaw (PL)

(Continued)

(72) Inventors: **Oron Zachar**, Tel Aviv (IL); **Yair Ramot**, Kfar Maas (IL); **Eizik Amar**, Ashdod (IL)

FOREIGN PATENT DOCUMENTS

EP 2550938 A1 * 1/2013 A61C 17/3436
JP 2016152936 A * 8/2016 A61C 17/3436

(73) Assignee: **Airway Medix S.A.**, Warsaw (PL)

Primary Examiner — Wan Laymon

(**) Term: **15 Years**

Assistant Examiner — Clint A Samuel

(21) Appl. No.: **29/591,615**

(74) *Attorney, Agent, or Firm* — Marc Van Dyke; Fourth Dimension IP

(22) Filed: **Jan. 21, 2017**

(57) **CLAIM**

(51) **LOC (11) Cl.** **04-02**

The ornamental design for a toothbrush assembly, as shown and described.

(52) **U.S. Cl.**

USPC **D4/111; D4/113**

DESCRIPTION

(58) **Field of Classification Search**

USPC D4/101, 104, 105, 108, 110, 111;
D24/111, 152, 176

CPC A46B 5/00; A46B 5/021; A46B 5/023;
A46B 5/026; A46B 5/028; A46B 5/0016;
A46B 5/0095; A46B 13/00; A46B 13/02;
A46B 2200/10; A46B 2200/30; A46B
2200/108; A46B 2200/302; A46B
2200/304; A46B 2200/1066; A46B
2200/1073; A46B 2200/1086; A46B
2200/3026; A46B 2200/3033; A46B
2200/3046; A61C 15/00; A61C 15/047;
A61C 15/048; A61C 17/16; A61C 17/22;
A61C 17/26

See application file for complete search history.

The patent or application file contains at least one drawing executed in color. Copies of this patent or patent application publication with color drawing(s) will be provided by the Office upon request and payment of the necessary fee.

FIG. 1 is a front view of a first embodiment of a toothbrush assembly showing the new design;

FIG. 2 is a back view thereof;

FIG. 3 is a left view thereof;

FIG. 4 is a right view thereof;

FIG. 5 is a top view thereof;

FIG. 6 is a bottom view thereof;

FIG. 7 is a perspective view thereof;

FIG. 8 is a front view of a second embodiment of the new design;

FIG. 9 is a back view thereof;

FIG. 10 is a left view thereof;

FIG. 11 is a right view thereof;

FIG. 12 is a top view thereof;

FIG. 13 is a bottom view thereof; and,

FIG. 14 is a perspective view thereof.

(56) **References Cited**

U.S. PATENT DOCUMENTS

D321,287 S * 11/1991 Woll D4/106
D361,433 S * 8/1995 Yang D4/101
D385,702 S * 11/1997 Okada D4/101
D424,303 S * 5/2000 Tobias D4/111
D452,775 S * 1/2002 Wright D4/101

1 Claim, 4 Drawing Sheets
(2 of 4 Drawing Sheet(s) Filed in Color)

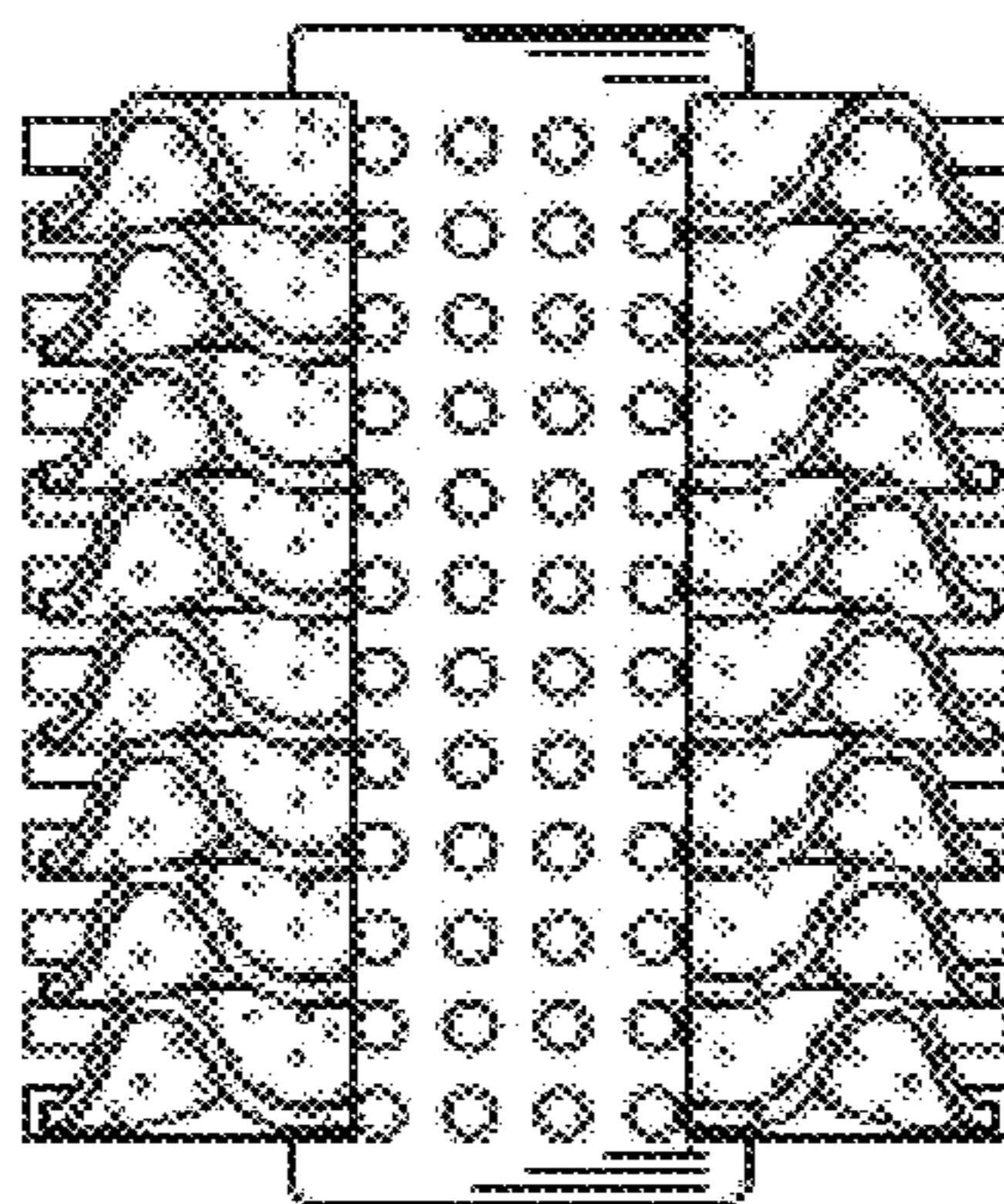

(56)

References Cited

U.S. PATENT DOCUMENTS

D489,534 S * 5/2004 Hensel D4/101
 D527,185 S * 8/2006 Vu D4/101
 D599,555 S * 9/2009 Oliphant D4/101
 D600,920 S * 9/2009 Yeh D19/125
 D607,646 S * 1/2010 Ino D4/101
 D648,539 S * 11/2011 Wai D4/101
 D648,941 S * 11/2011 Leung D4/101
 D688,464 S * 8/2013 Hara D4/101
 D696,023 S * 12/2013 Gebski D4/101
 D696,517 S * 12/2013 Gebski D4/101
 D702,947 S * 4/2014 Lee D4/101
 D719,737 S * 12/2014 Adriaenssen D4/101
 D743,173 S * 11/2015 Sohn D4/101
 D751,821 S * 3/2016 Since D4/101
 D759,380 S * 6/2016 Watkins D4/101
 D759,381 S * 6/2016 Watkins D4/101
 D759,383 S * 6/2016 Watkins D4/101
 D766,580 S * 9/2016 Kollar D4/101
 D767,895 S * 10/2016 Stebila D4/101
 D771,952 S * 11/2016 Sedic D4/104
 D773,192 S * 12/2016 Nabavi D4/101
 D773,822 S * 12/2016 Sikora D4/101
 D774,772 S * 12/2016 Sedic D4/101
 D774,773 S * 12/2016 Sedic D4/101
 D775,836 S * 1/2017 Sedic D4/101
 D776,438 S * 1/2017 Sedic D4/111

D778,057 S * 2/2017 Sohn D4/101
 D780,455 S * 3/2017 Kandemir D4/101
 D787,189 S * 5/2017 Fretwell D4/101
 D795,590 S * 8/2017 Sedic D4/101
 D799,217 S * 10/2017 Massee D4/101
 D801,696 S * 11/2017 McGarry D4/101
 D834,322 S * 11/2018 Sohn D4/101
 D834,323 S * 11/2018 Sohn D4/101
 2002/0100134 A1 * 8/2002 Dunn A46B 5/00
 15/167.1
 2003/0031979 A1 * 2/2003 Shortt A61C 17/22
 433/118
 2003/0101526 A1 * 6/2003 Hilscher A61C 17/22
 15/22.1
 2011/0010874 A1 * 1/2011 Dickie A46B 5/0062
 15/22.1
 2013/0007969 A1 * 1/2013 Driesen A61C 17/3436
 15/28
 2013/0133683 A1 * 5/2013 Guthans A45D 6/04
 132/237
 2015/0173502 A1 * 6/2015 Sedic A46B 9/04
 15/22.1
 2016/0287363 A1 * 10/2016 Miller A61C 17/221
 2016/0374609 A1 * 12/2016 Vetter A61C 17/16
 433/27
 2017/0042638 A1 * 2/2017 Lee A61C 17/028
 2017/0151044 A1 * 6/2017 Okai A61C 17/222

* cited by examiner

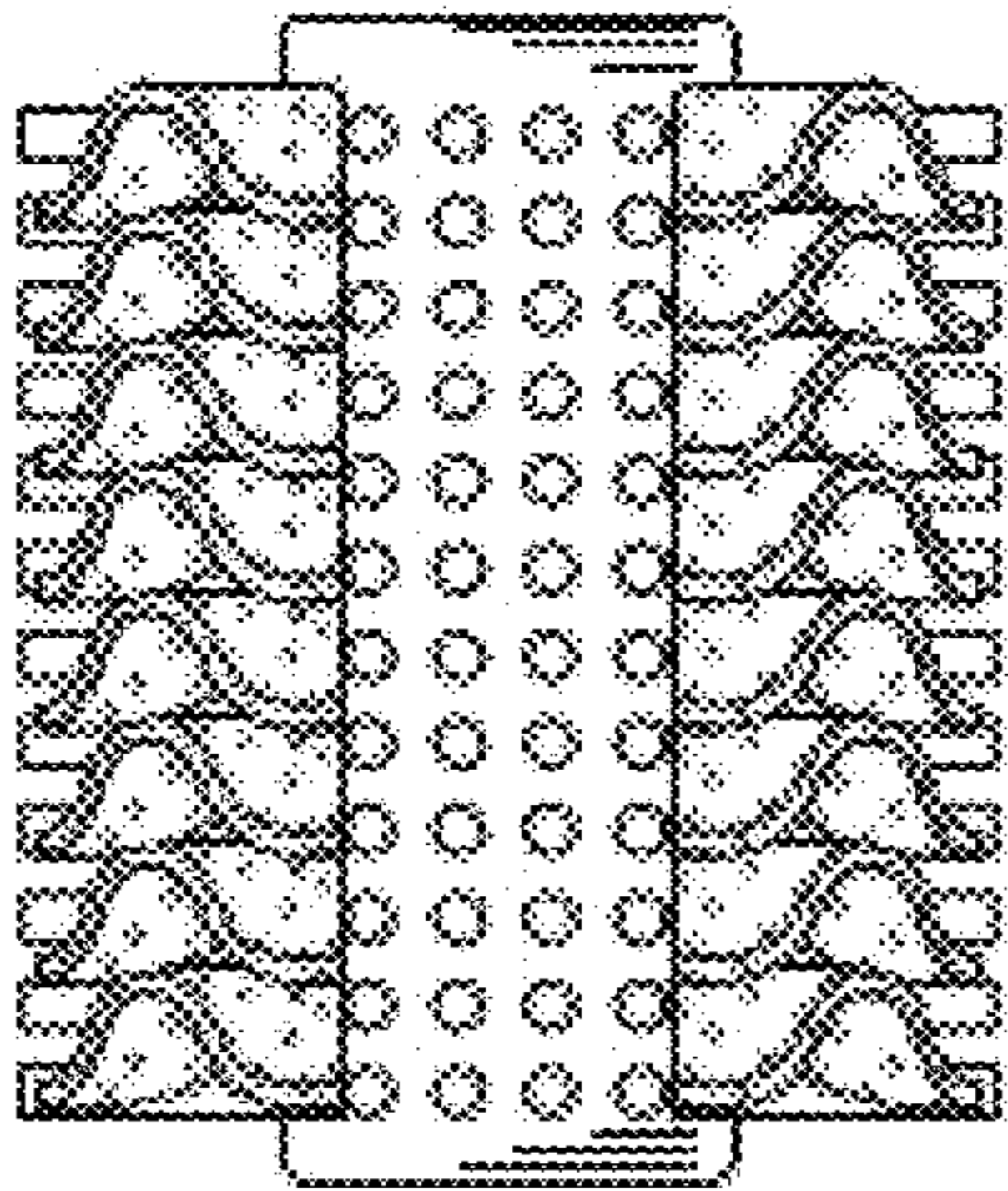

Figure 1

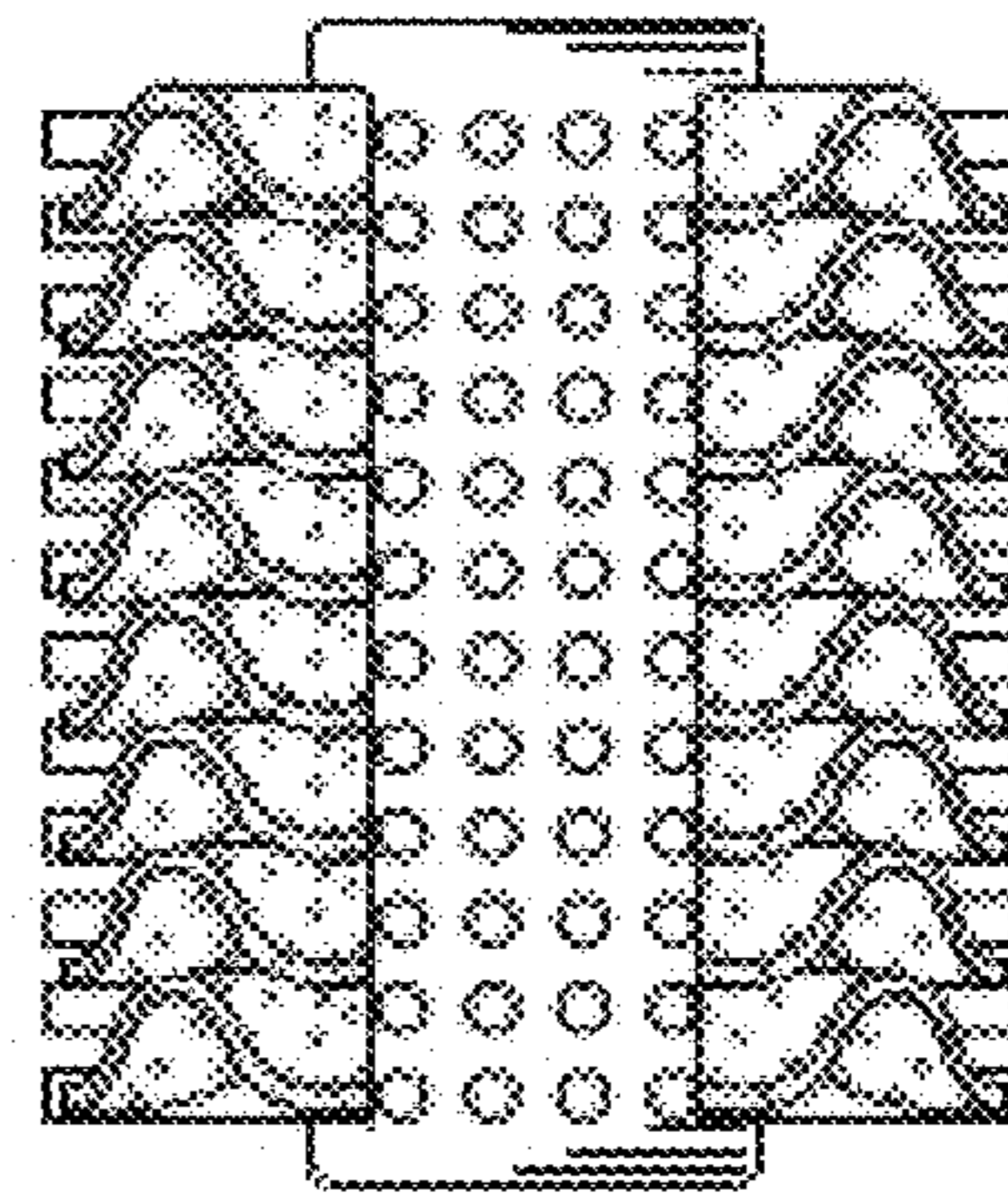

Figure 2

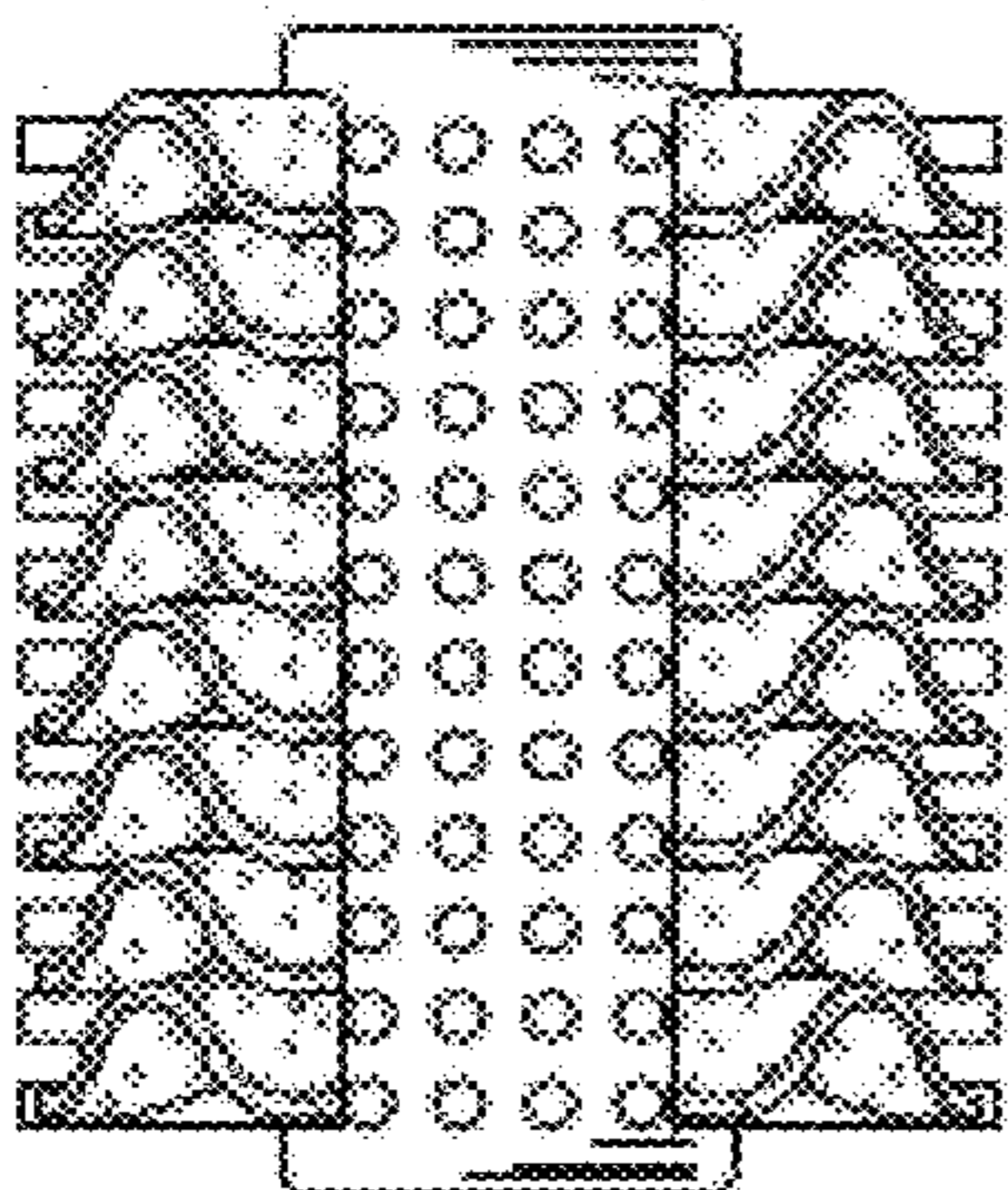

Figure 3

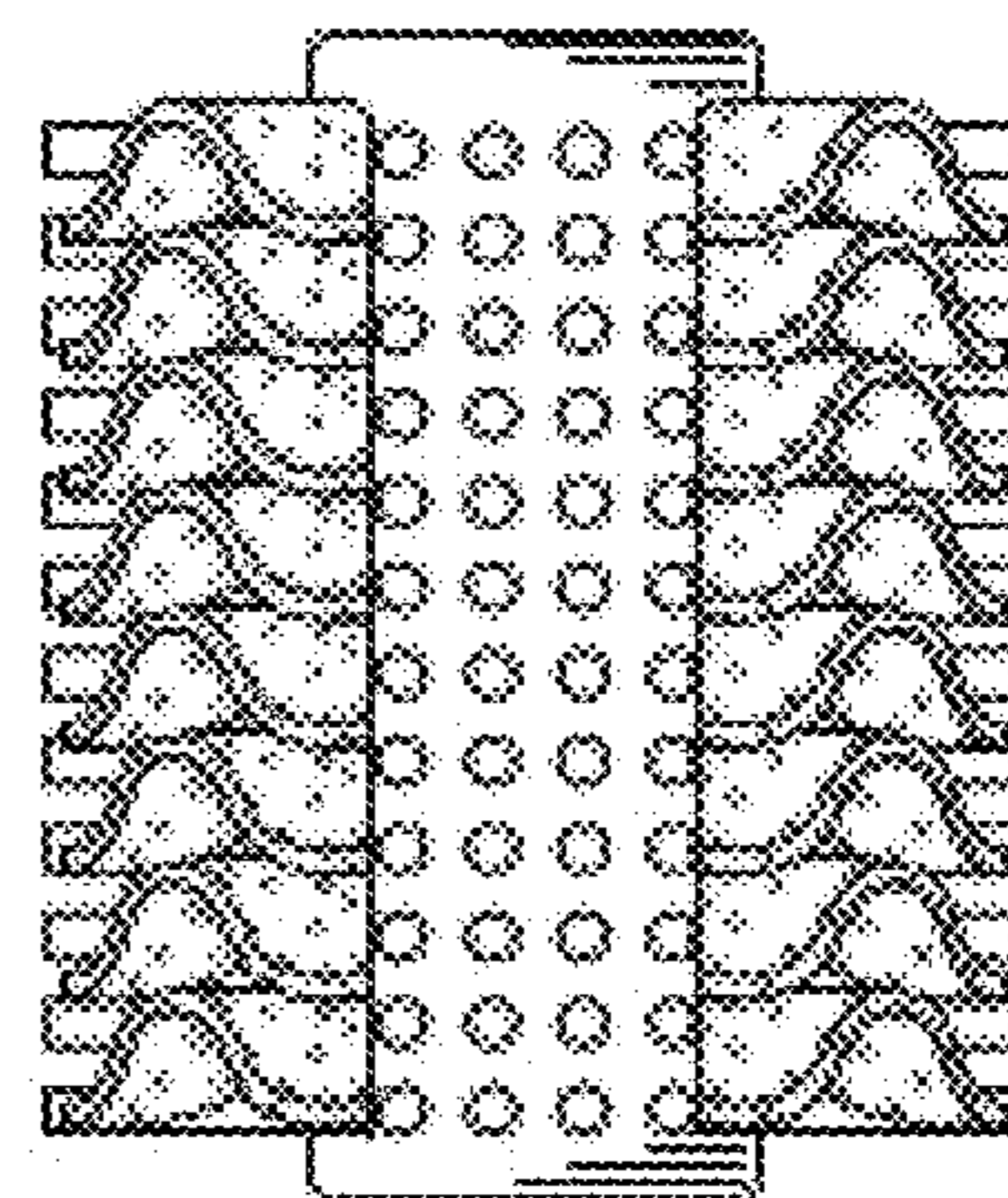

Figure 4

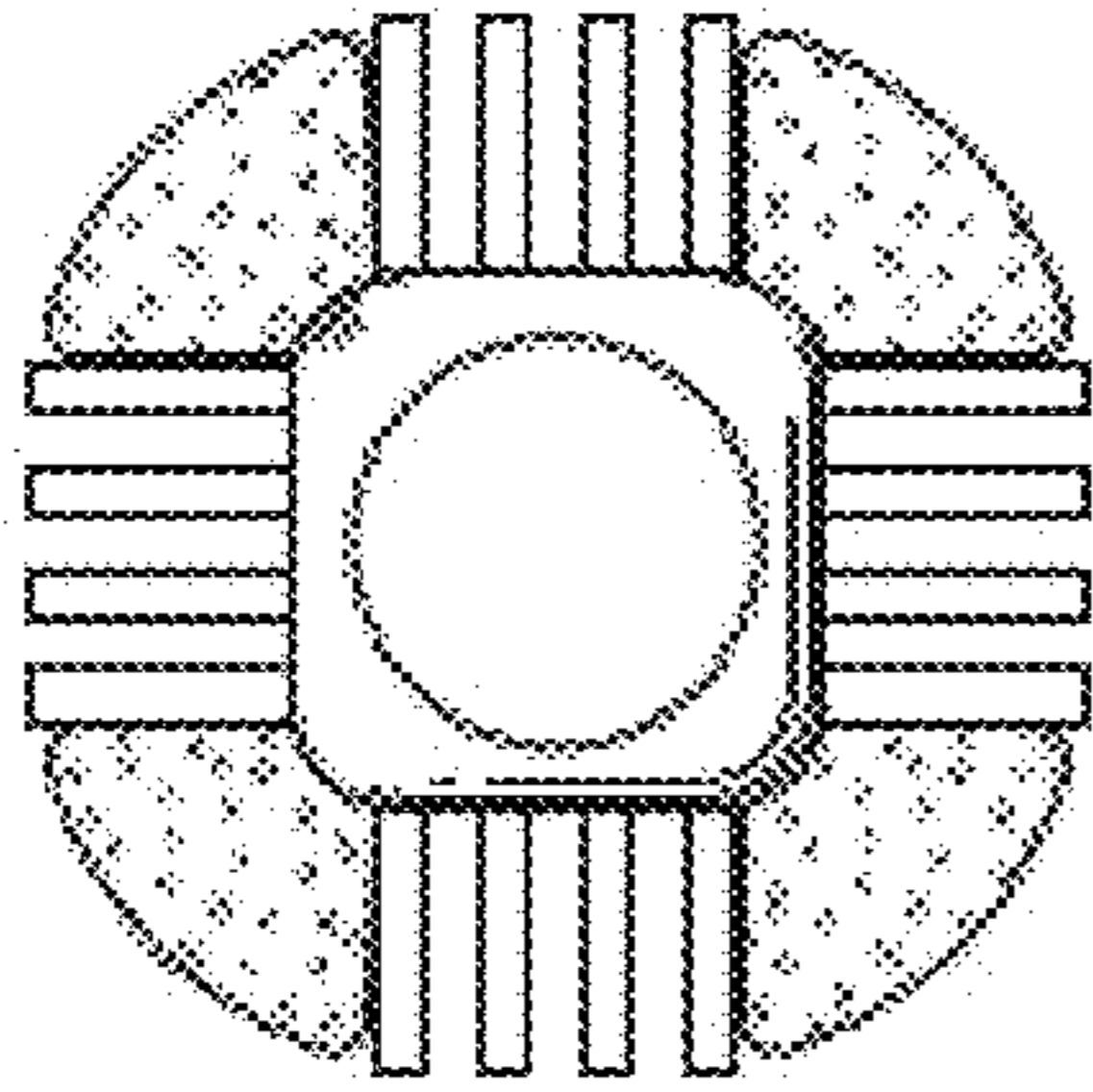

Figure 5

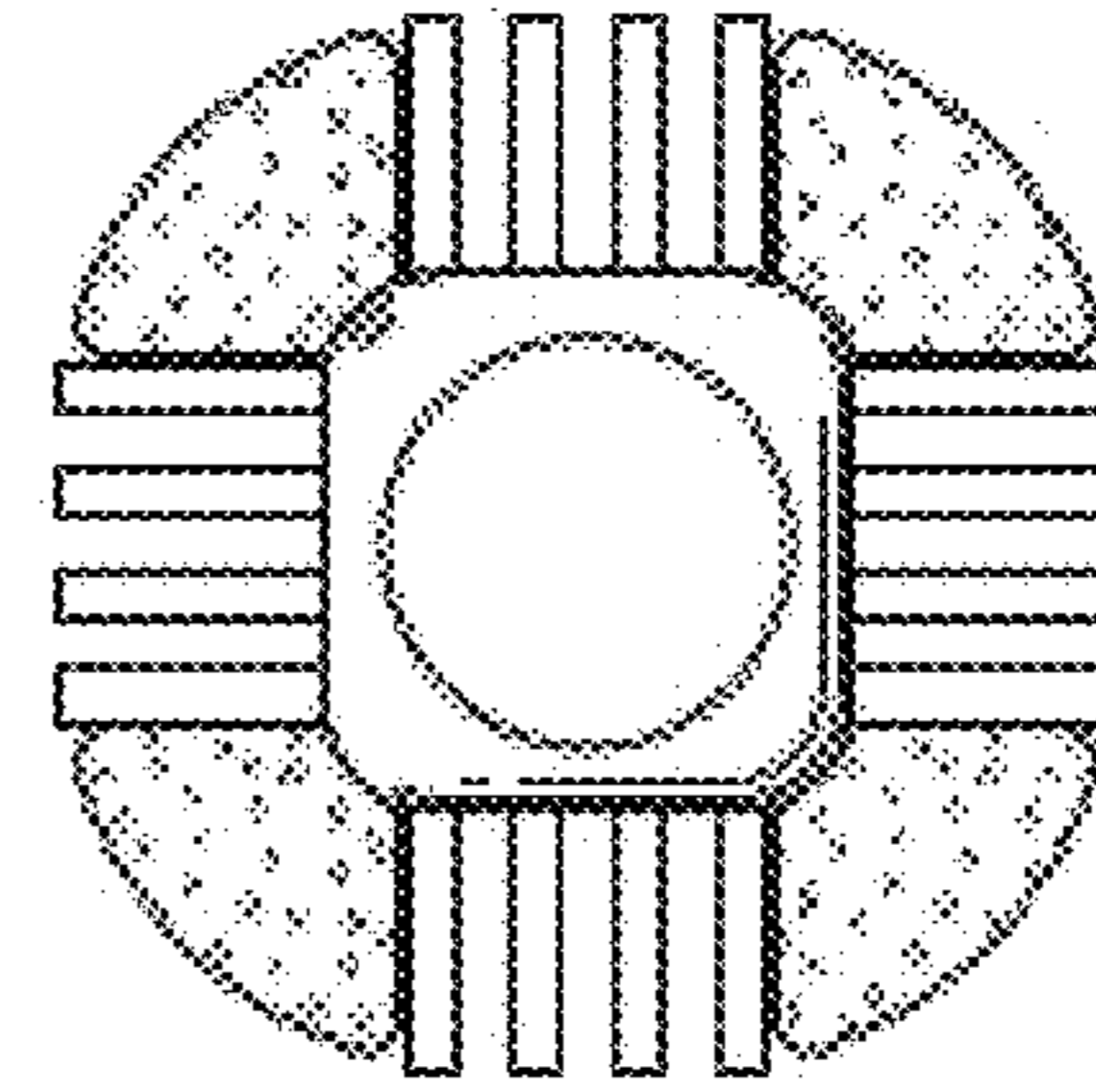

Figure 6

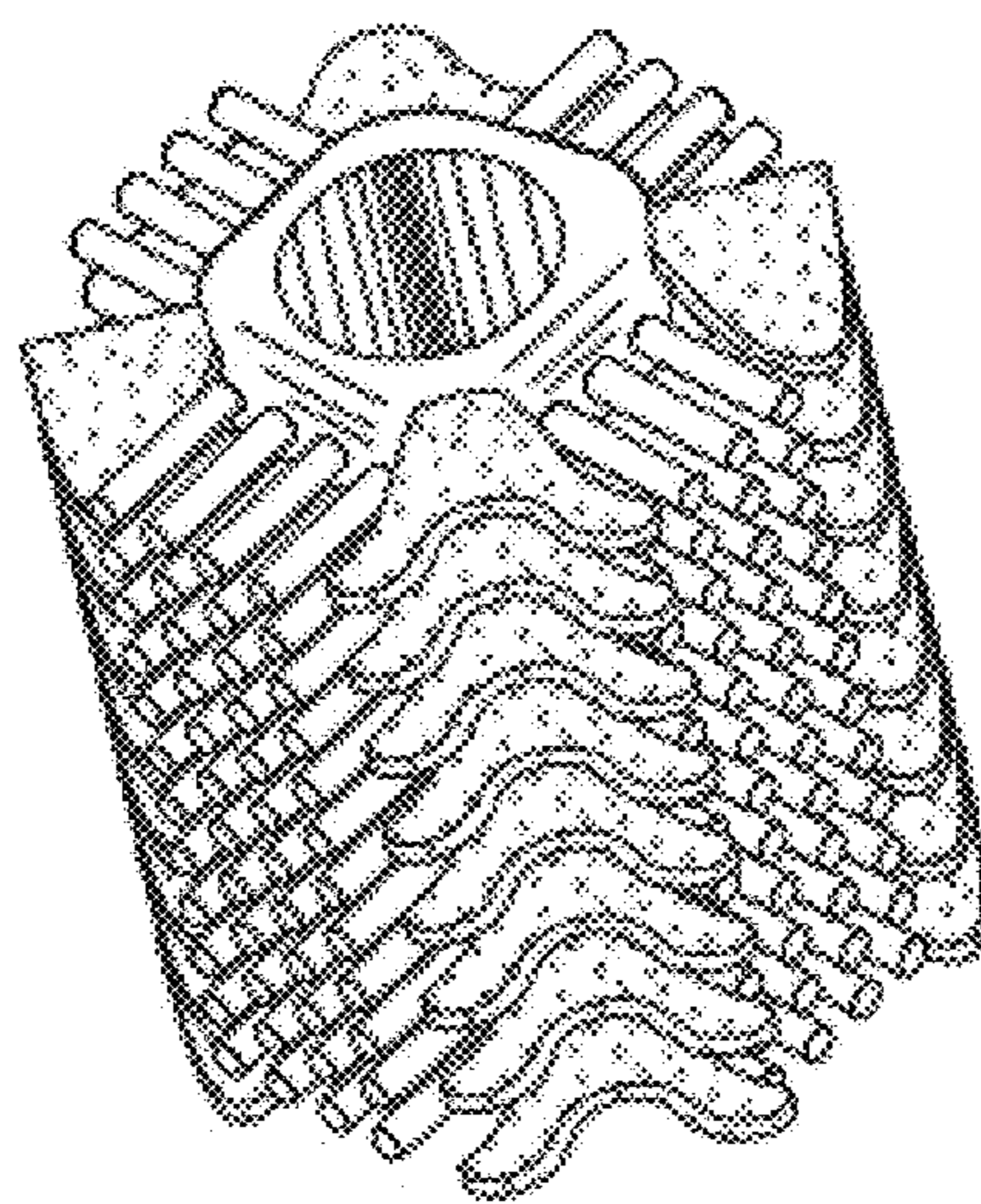

Figure 7

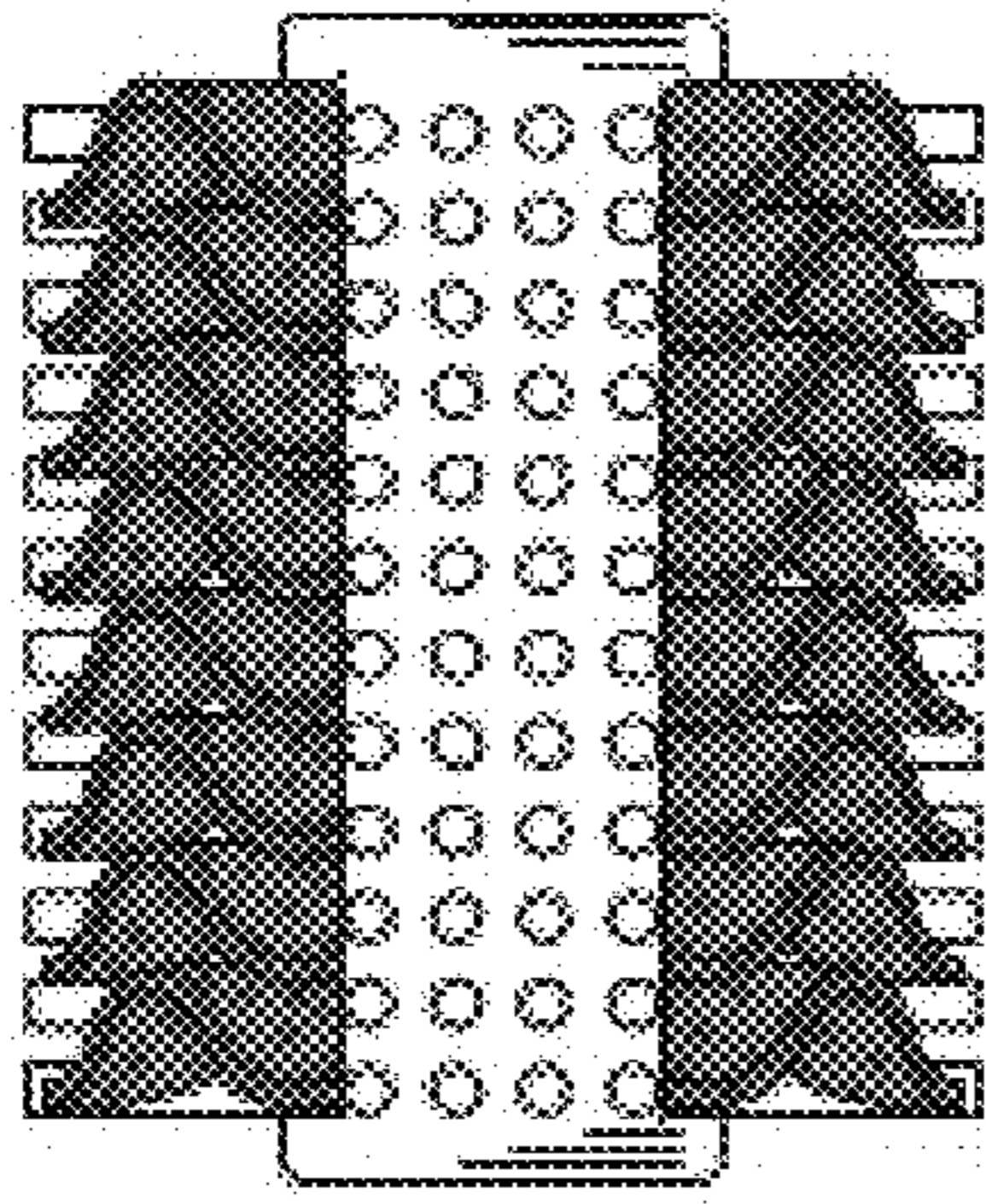

Figure 8

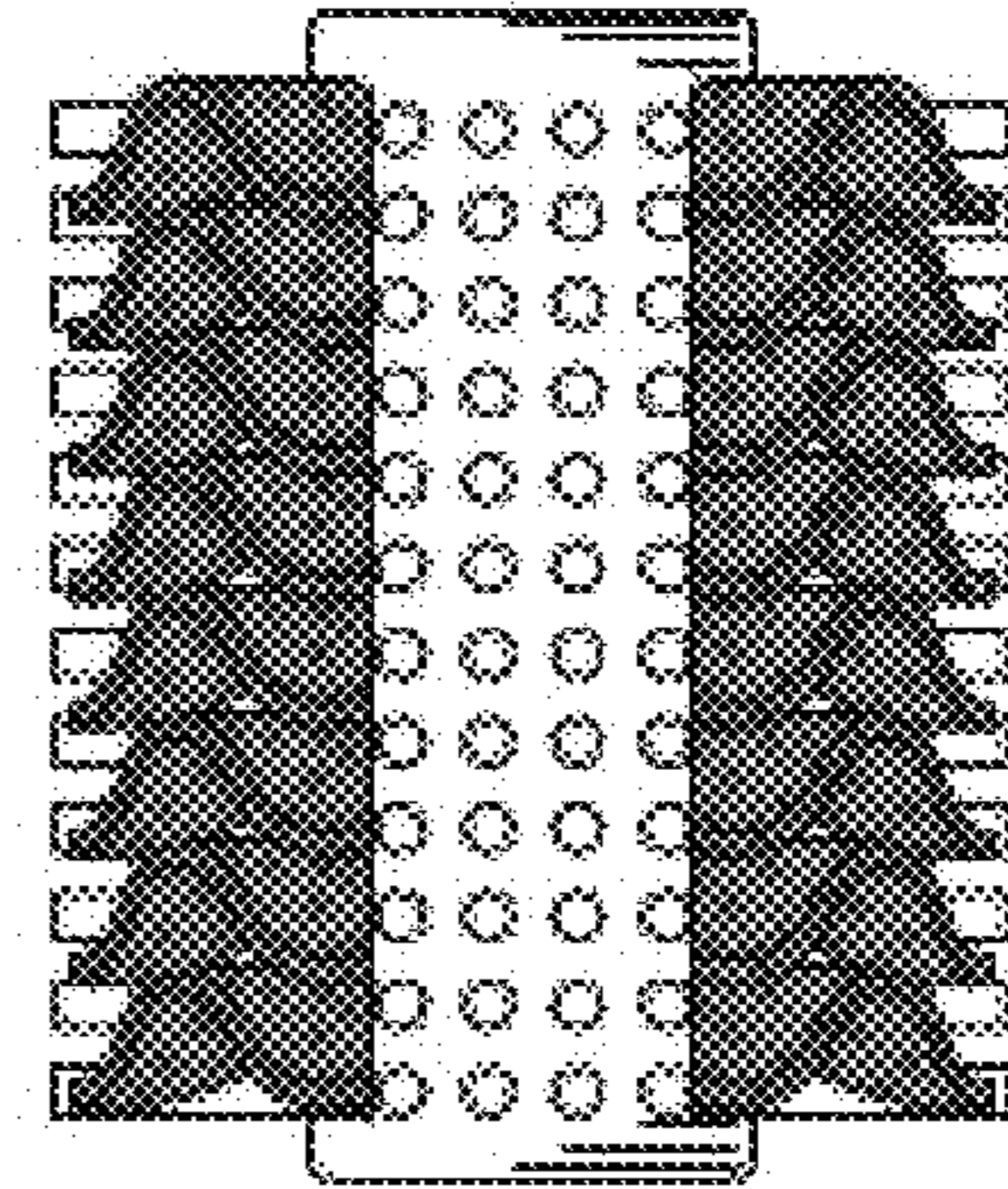

Figure 9

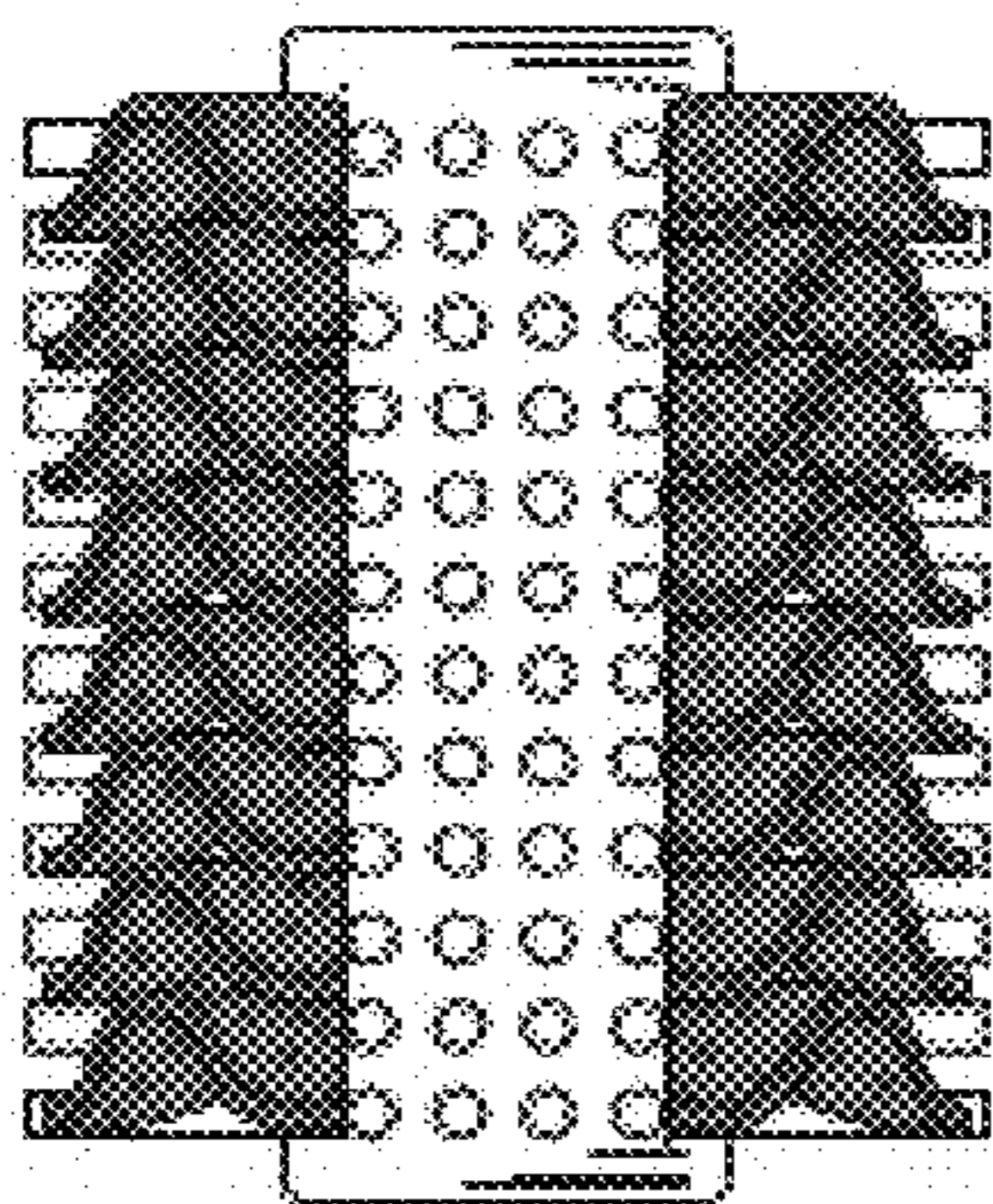

Figure 10

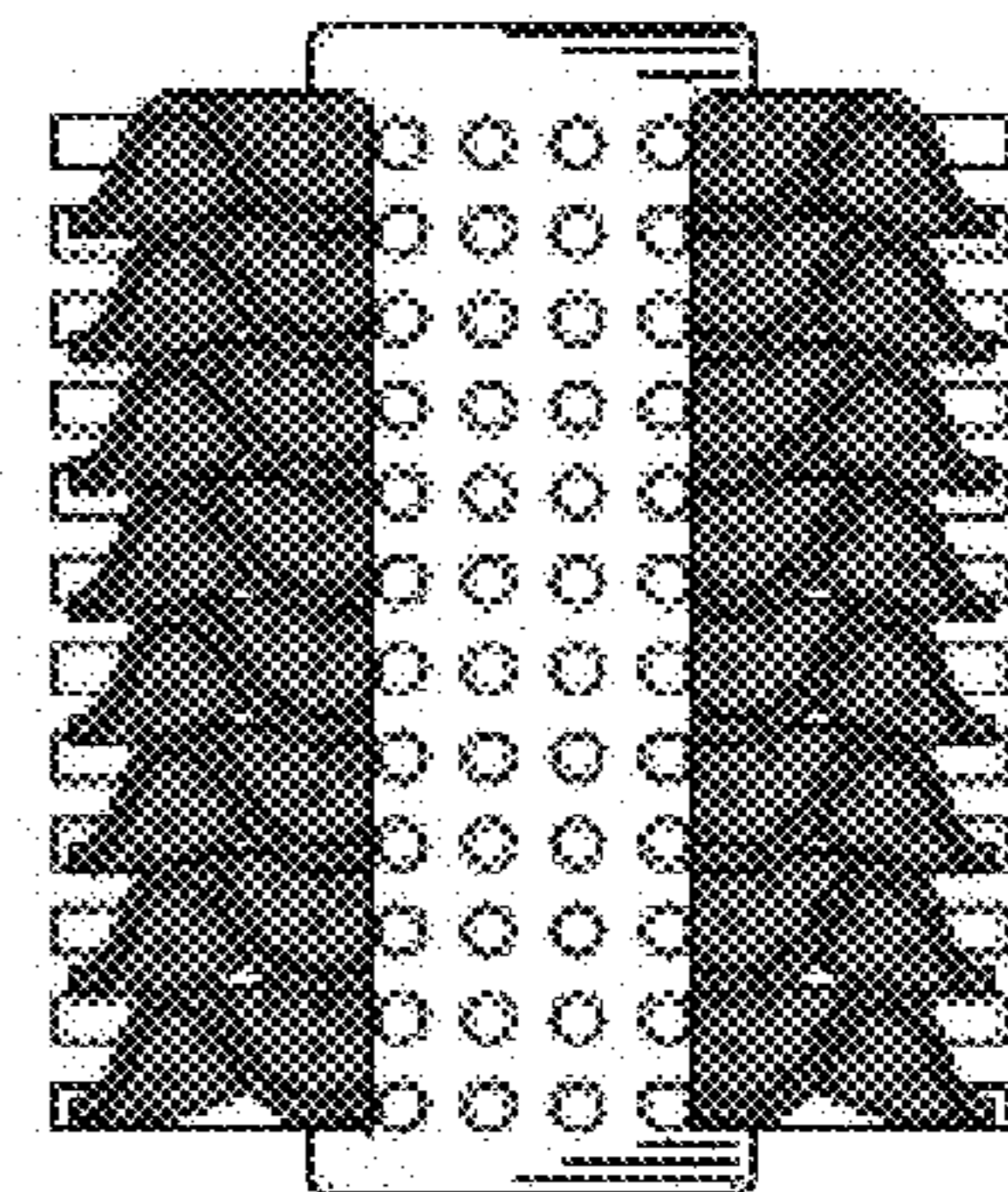

Figure 11

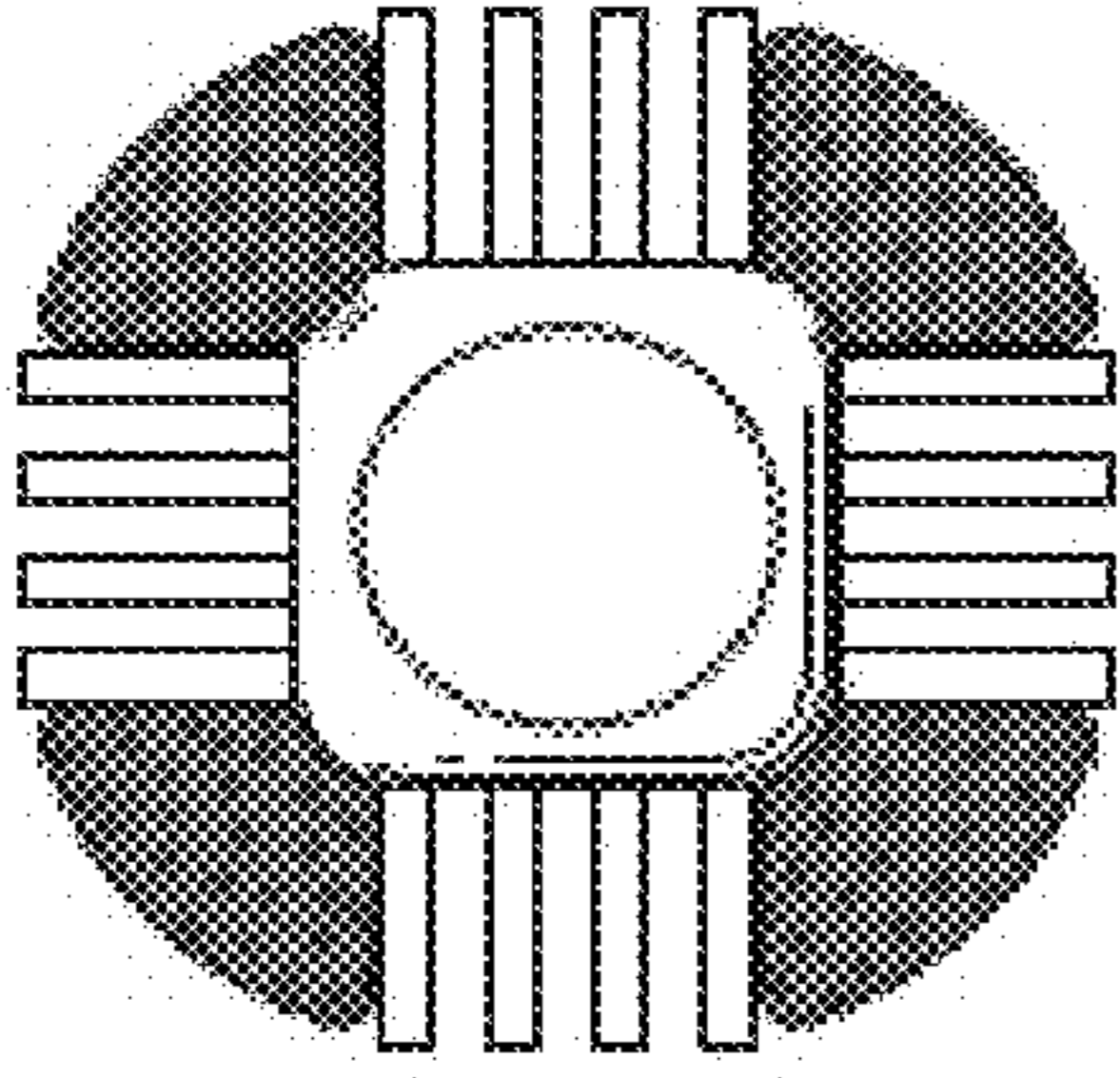

Figure 12

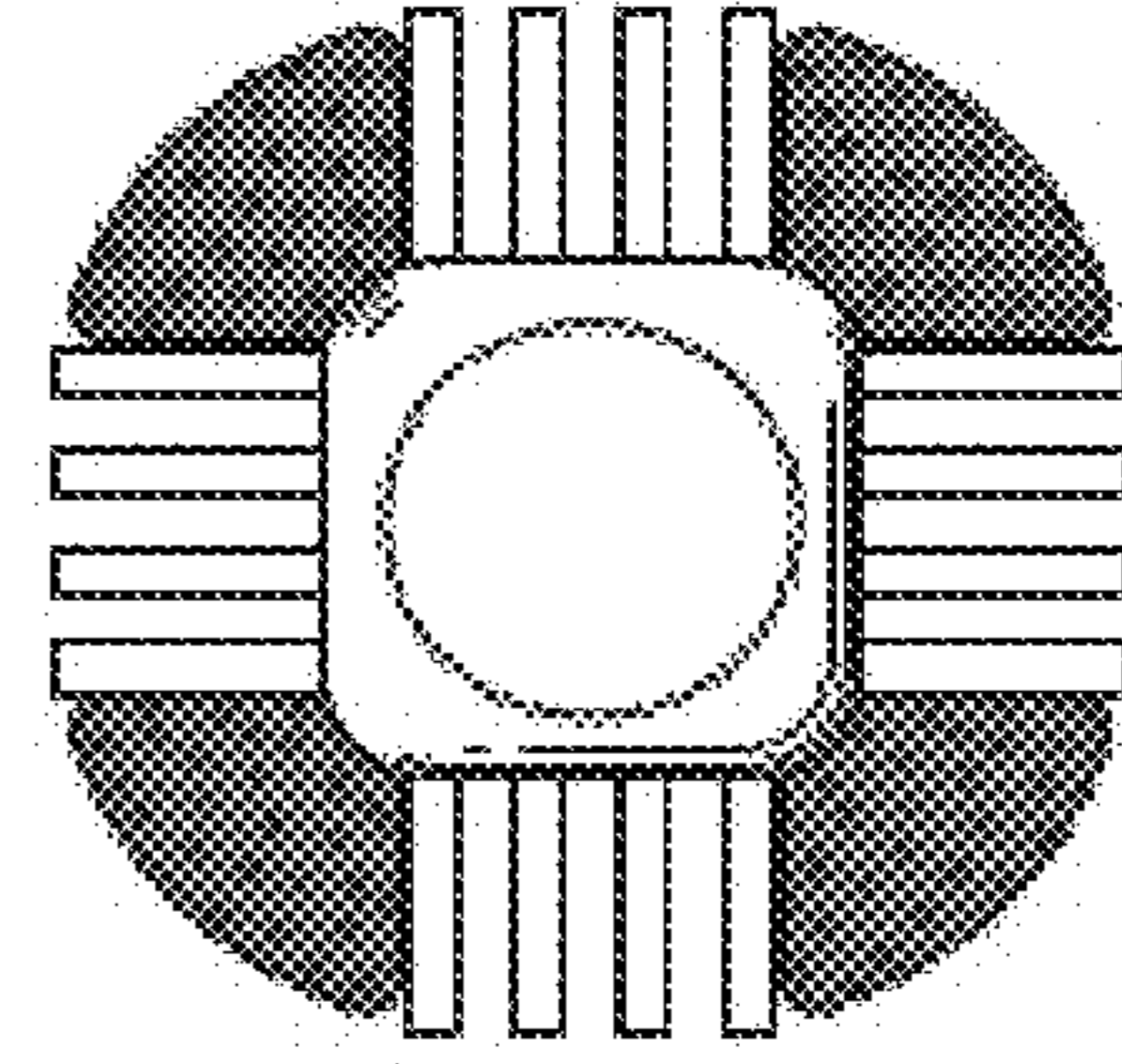

Figure 13

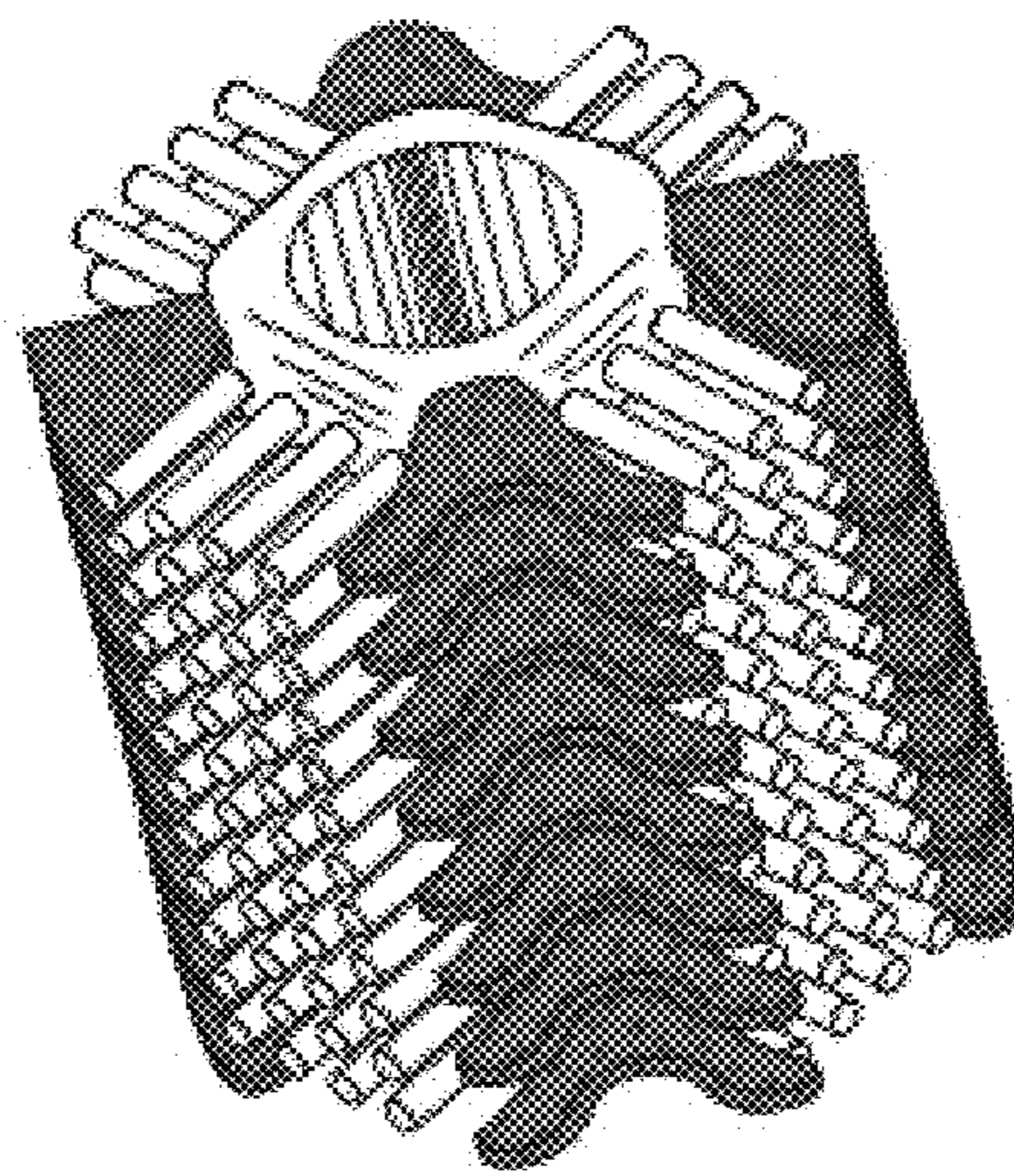

Figure 14