



US00D852354S

(12) **United States Design Patent**
Wrangmark et al.

(10) **Patent No.:** **US D852,354 S**
(45) **Date of Patent:** **** Jun. 25, 2019**

(54) **FASTENER FOR MEDICAL TUBES LINES AND CABLES**

(71) Applicant: **MEDOW AB**, Lund (SE)

(72) Inventors: **Linn Wrangmark**, Lund (SE); **Frida McCabe**, Lund (SE)

(73) Assignee: **Medow, AB**, Lund (SE)

(**) Term: **15 Years**

(21) Appl. No.: **35/504,462**

(22) Filed: **Aug. 15, 2017**

(80) **Hague Agreement Data**

Int. Filing Date: **Aug. 15, 2017**
Int. Reg. No.: **DM/098771**
Int. Reg. Date: **Aug. 15, 2017**
Int. Reg. Pub. Date: **Feb. 16, 2018**

(30) **Foreign Application Priority Data**

Feb. 24, 2017 (EM) 003764901-0002

(51) **LOC (11) Cl.** **24-02**

(52) **U.S. Cl.**
USPC **D24/128**; D13/155; D8/356

(58) **Field of Classification Search**
USPC D24/128, 129; D13/155; D8/356, 382, D8/383
CPC H02G 3/04; F16L 3/223
See application file for complete search history.

(56) **References Cited**

U.S. PATENT DOCUMENTS

4,154,011 A * 5/1979 Rakestraw G09F 3/005
283/75
4,244,544 A * 1/1981 Kornat F16L 3/13
248/68.1
D336,131 S * 6/1993 Nordstrom D24/128

5,316,246 A * 5/1994 Scott A61M 5/1418
248/68.1
D425,987 S * 5/2000 Goldstein D24/128
6,431,500 B1 * 8/2002 Jacobs F16L 3/13
24/129 R
D568,723 S * 5/2008 Morgan D8/356
D638,692 S * 5/2011 Hoek D8/356
D640,592 S * 6/2011 Wanibuchi D11/226
D648,685 S * 11/2011 Symons D13/155
D774,002 S * 12/2016 Hsieh D13/155
D817,486 S * 5/2018 Corato D24/128

(Continued)

OTHER PUBLICATIONS

“Medow is feeling pumped”. Found online Jan. 11, 2019 at facebook.com. Page dated Jan. 13, 2017. Retrieved from https://www.facebook.com/MedowHealthCareSolutions/?ref=page_internal.*

(Continued)

Primary Examiner — George D. Kirschbaum
Assistant Examiner — Kendra Leslie Hamilton
(74) *Attorney, Agent, or Firm* — Volpe and Koenig, P.C.

(57) **CLAIM**

The ornamental design for a fastener for medical tubes, lines and cables, as shown and described.

DESCRIPTION

1. Fastener for medical tubes, lines and cables

1.1 : Perspective

1.2 : Perspective

1.3 : Front

1.4 : Back

1.5 : Top

1.6 : Left

1.7 : Bottom

Equipment for delivering medication to a patient.

The broken lines in the drawings depict portions of the fastener for medical tubes lines and cables that form no part of the claimed design.

1 Claim, 7 Drawing Sheets

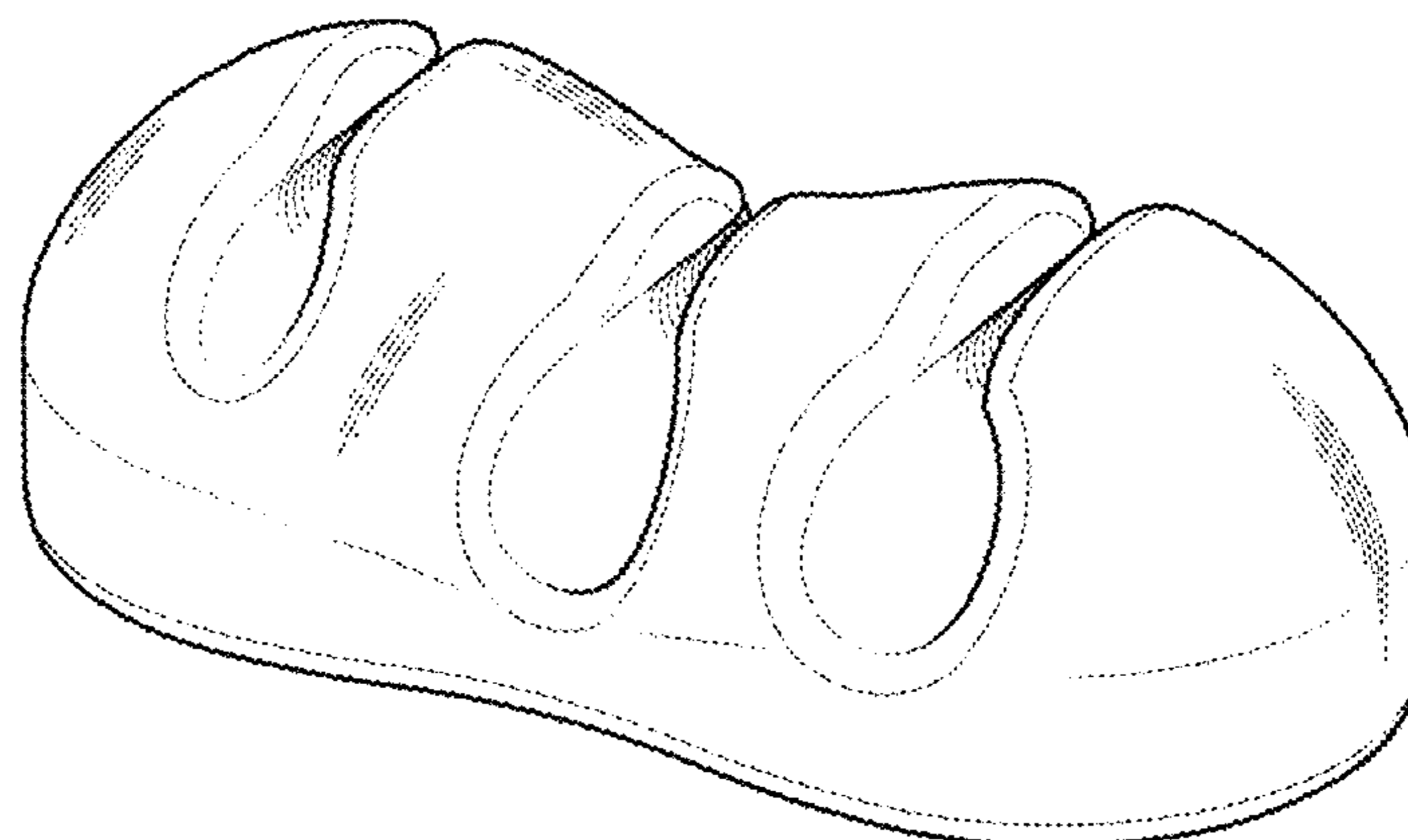

(56)

References Cited

U.S. PATENT DOCUMENTS

D827,417 S * 9/2018 Nelson D8/356

OTHER PUBLICATIONS

“Cord Organizers Help You Win The War Against Messy Desks”. Found online Jan. 14, 2019 at homedit.com. Page dated Jul. 17, 2016 . Retrieved from <https://web.archive.org/web/20160717143312/https://www.homedit.com/cord-organizer/>.*

“BlueLounge CableDrop Multi”. Found online Jan. 14, 2019 at bluelounge.com. Page dated Dec. 27, 2016. Retrieved from <https://web.archive.org/web/20161227193818/https://www.bluelounge.com/products/cabledrop-multi>.*

“JOTO Cable Clips Cord Management Organizer”. Found online Jan. 14, 2019 at amazon.com. Page dated Dec. 26, 2015. Retrieved from https://www.amazon.com/JOTO-Management-Organizer-Electronics-Computer/dp/B016ZJDWZE/ref=sr_1_28?ie=UTF8&qid=1547512941&sr=8-28&keywords=cable+clip.*

* cited by examiner

1.1

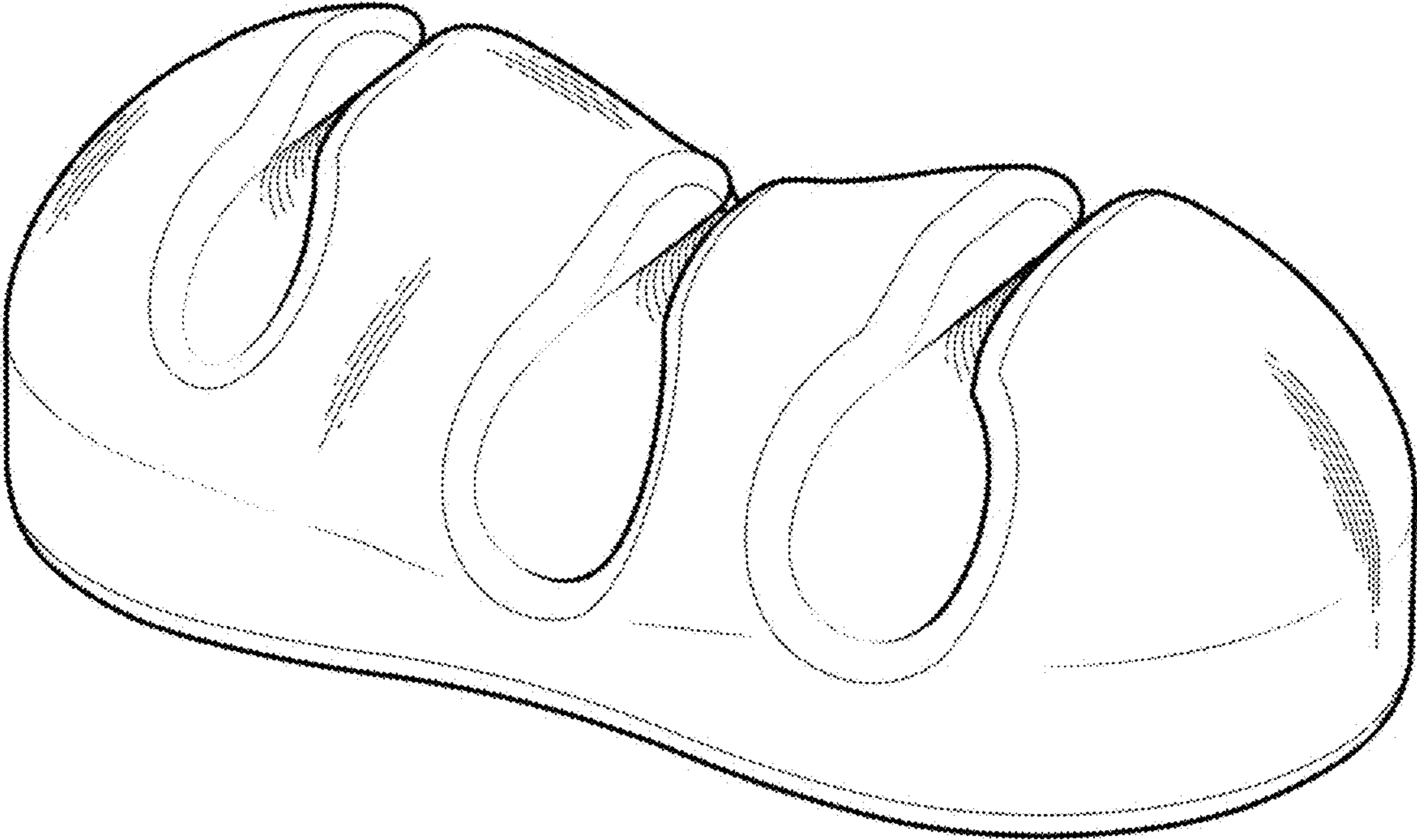

1.2

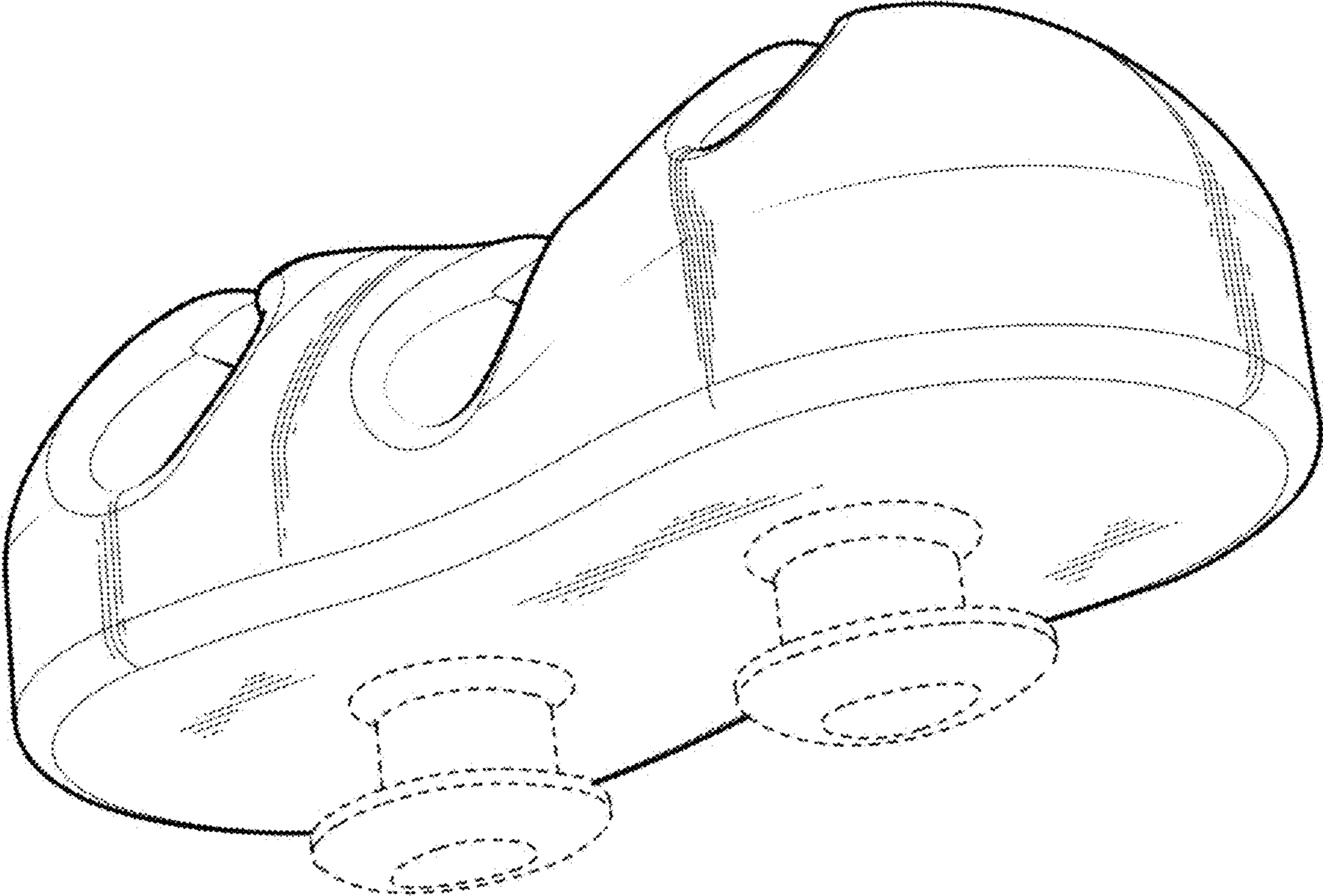

1.3

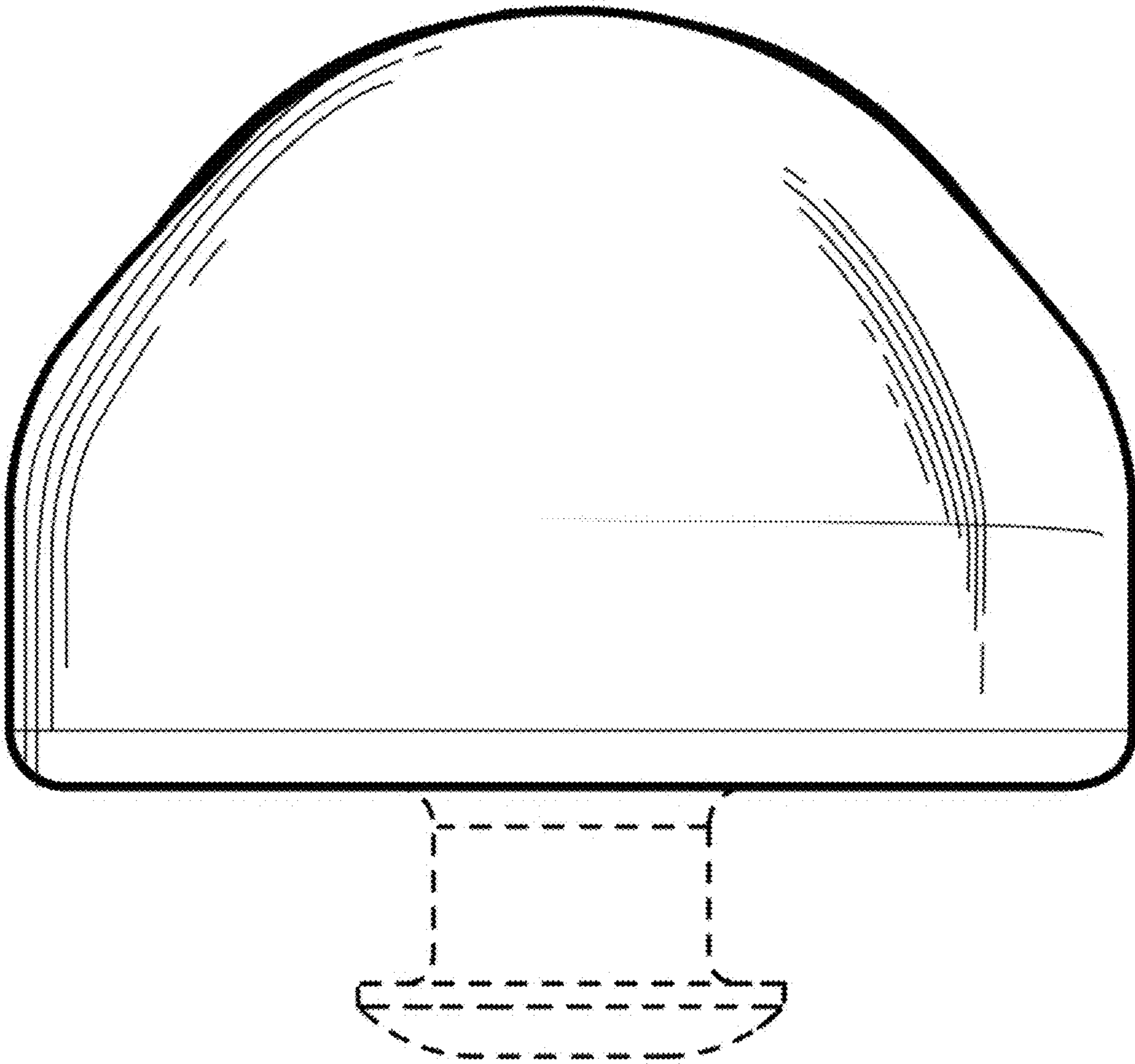

1.4

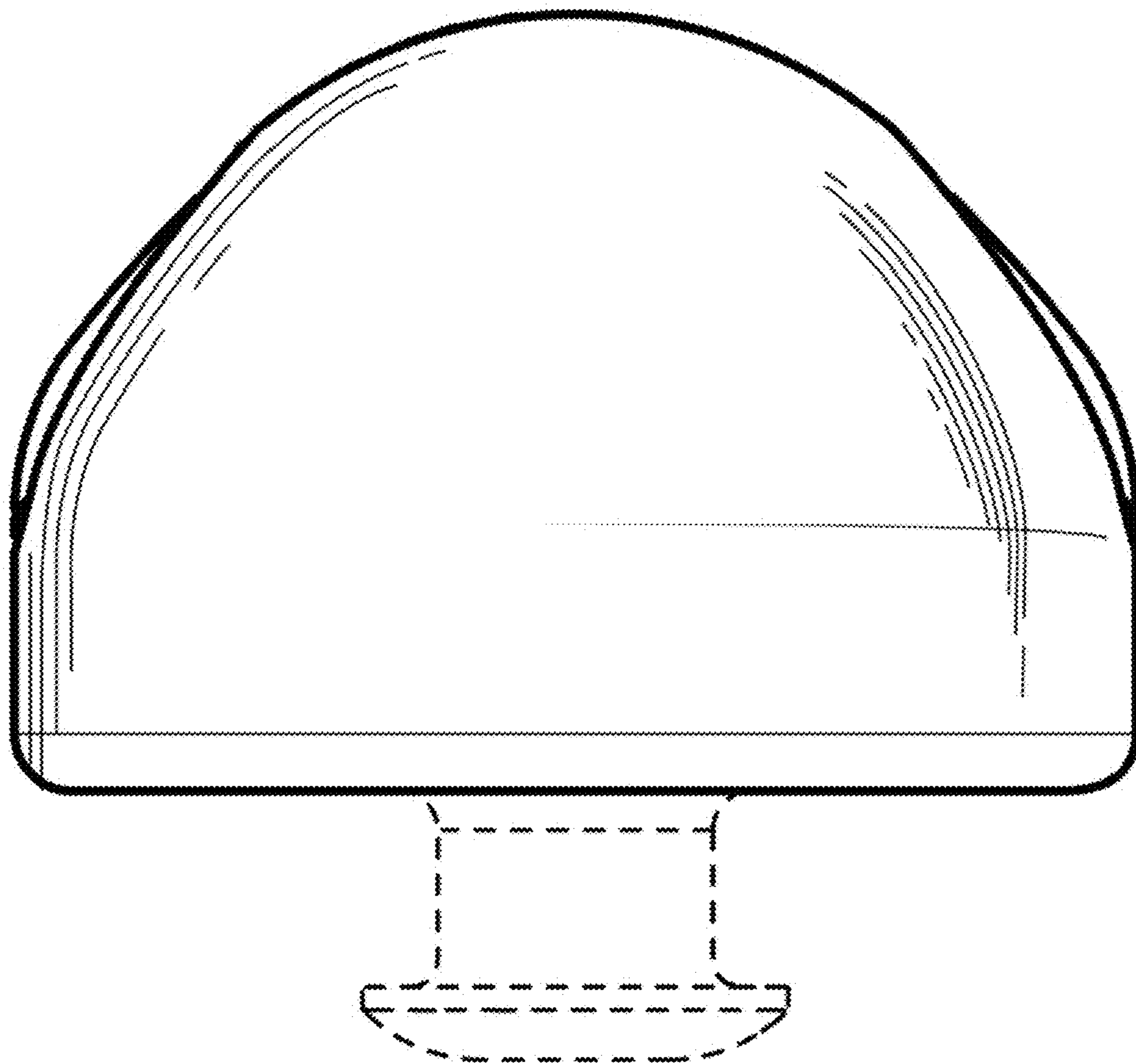

1.5

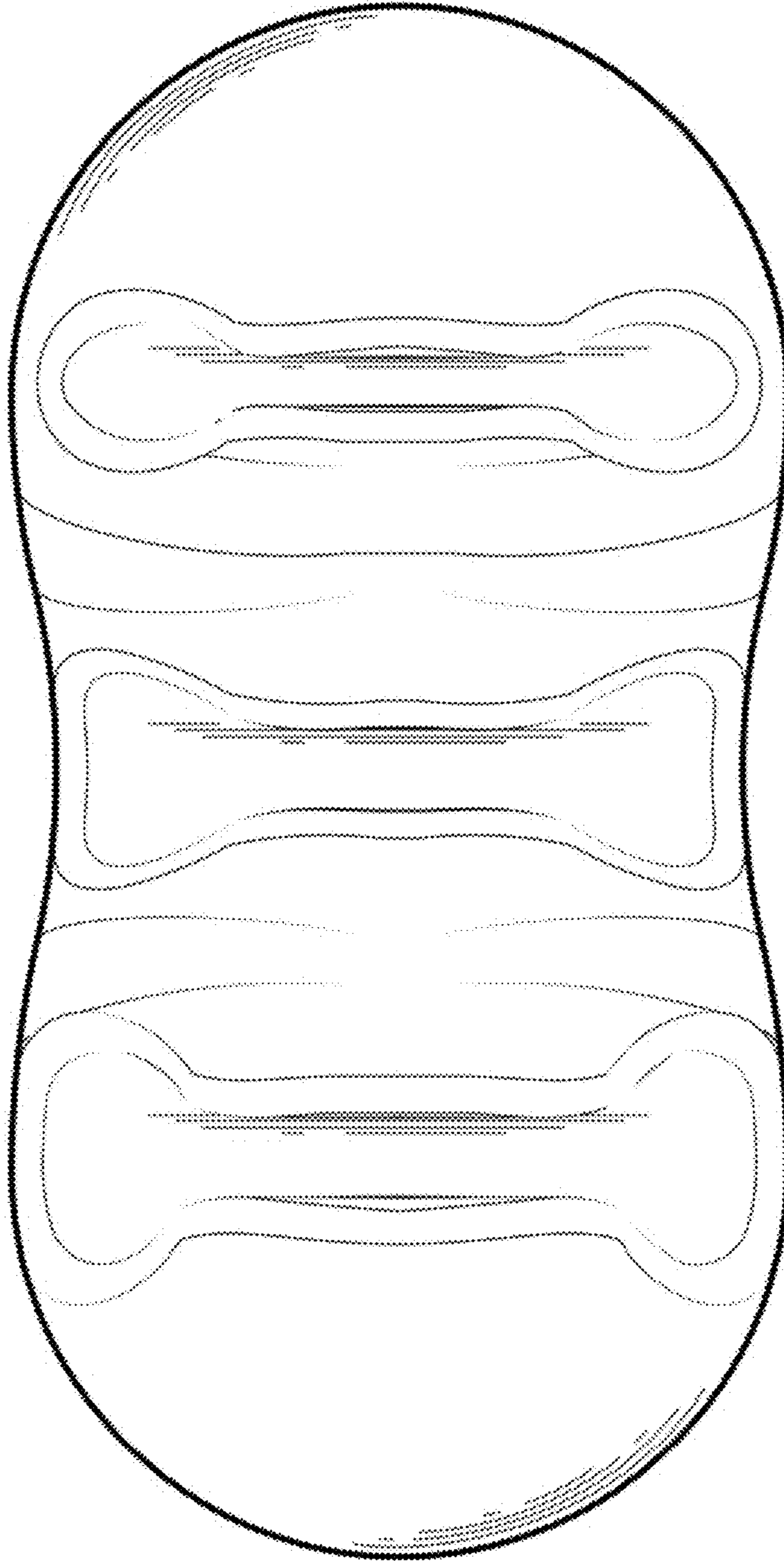

1.6

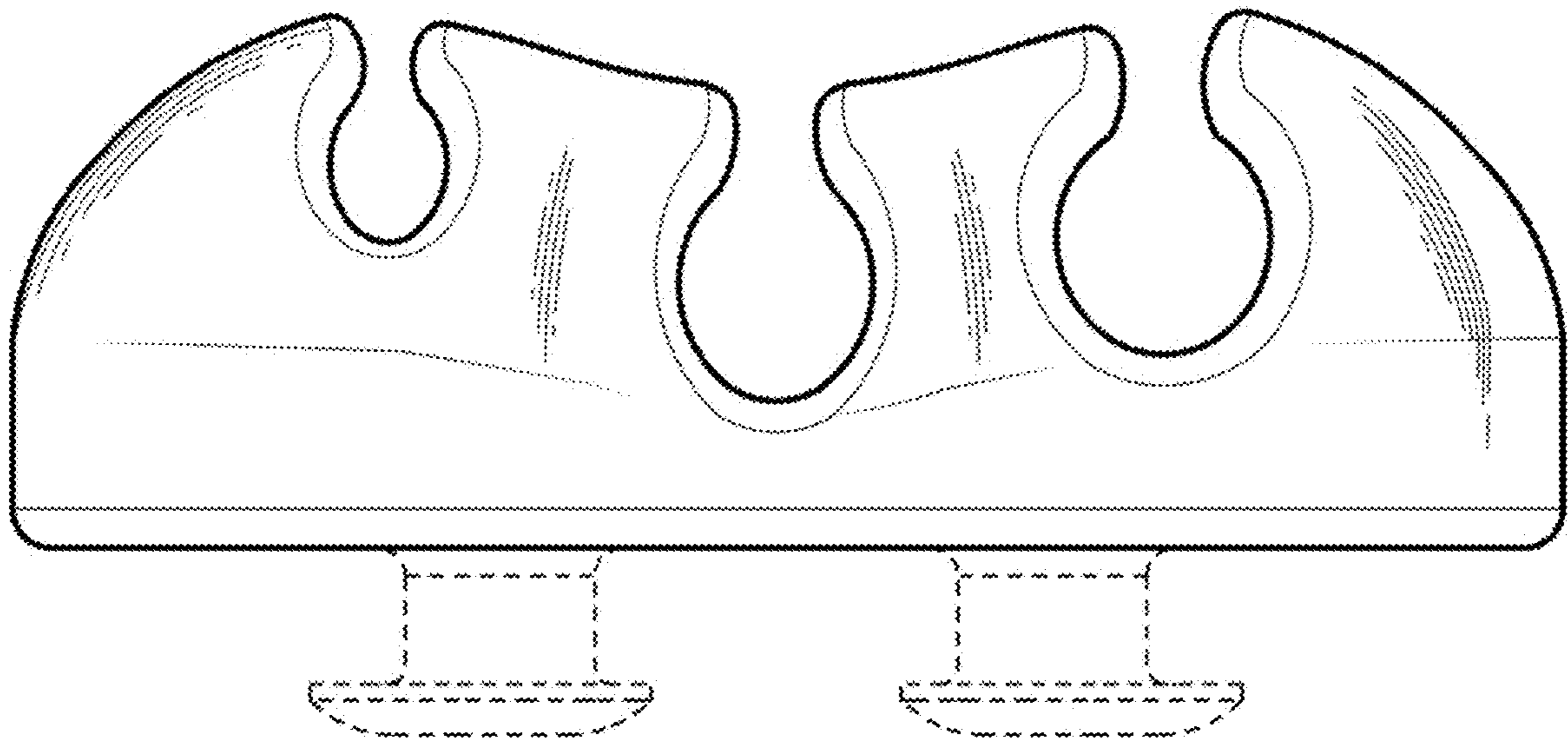

1.7

