



US00D852344S

(12) **United States Design Patent**
Hua

(10) **Patent No.:** **US D852,344 S**
(45) **Date of Patent:** **** Jun. 25, 2019**

(54) **AIR PURIFIER**

(71) Applicant: **KONINKLIJKE PHILIPS N.V.**,
Eindhoven (NL)

(72) Inventor: **Hao Hua**, Shanghai (CN)

(73) Assignee: **KONINKLIJKE PHILIPS N.V.**,
Eindhoven (NL)

(**) Term: **15 Years**

(21) Appl. No.: **35/504,545**

(22) Filed: **Sep. 4, 2017**

(80) **Hague Agreement Data**

Int. Filing Date: **Sep. 4, 2017**

Int. Reg. No.: **DM/097580**

Int. Reg. Date: **Sep. 4, 2017**

Int. Reg. Pub. Date: **Mar. 9, 2018**

(51) **LOC (11) Cl.** **23-04**

(52) **U.S. Cl.**
USPC **D23/364**
CPC **A61L 9/16** (2013.01)

(58) **Field of Classification Search**
USPC D23/355-366, 352, 369, 332, 333, 335,
D23/336, 342, 351; 422/120, 122;
55/356, 473, 504; D14/188, 170, 172;
261/DIG. 17, DIG. 65, DIG. 88, DIG. 31;
D18/34.6
CPC .. A61L 9/16; A61L 9/22; B01D 47/00; B01D
47/027; B01D 2221/02; B01D 2259/4508;
F24F 3/16; F24F 13/20; F24F 13/28;
F24F 3/1405; F24F 3/1603; F24F 13/222;
B03C 3/155; B03C 3/368
See application file for complete search history.

(56) **References Cited**

U.S. PATENT DOCUMENTS

D287,274 S * 12/1986 Crowley D23/356
D299,528 S * 1/1989 Kessler D23/351

D394,099 S * 5/1998 Tsuji D23/356
D565,159 S * 3/2008 Shin D23/356
D657,037 S * 4/2012 Lo D23/364
D677,773 S * 3/2013 Choi D23/356
D682,406 S * 5/2013 Yeom D23/356
D688,362 S * 8/2013 Thomas D23/356
D704,321 S * 5/2014 Jardine D23/365
D726,766 S * 4/2015 Goodner D14/188
D728,089 S * 4/2015 Crisa' D23/366
D733,273 S * 6/2015 Jeon D23/333
D735,843 S * 8/2015 Sunwoo D23/333
D755,942 S * 5/2016 Kim D23/364
D778,424 S * 2/2017 Jonas D23/388
D778,425 S * 2/2017 Jonas D23/388
D779,050 S * 2/2017 Jonas D23/388
D782,019 S * 3/2017 Kim D23/364
D784,511 S * 4/2017 Jonas D23/388
D784,512 S * 4/2017 Jonas D23/388
D786,413 S * 5/2017 Martin, Sr. D23/351
D791,290 S * 7/2017 Shapiro D23/332
D799,016 S * 10/2017 Su D23/364
D804,627 S * 12/2017 Puffer D23/371
D807,998 S * 1/2018 Kim D23/364
D811,572 S * 2/2018 Hu D23/364
D814,009 S * 3/2018 Puffer D23/371
D815,724 S * 4/2018 Jonas D23/385
D816,206 S * 4/2018 Jonas D23/385

(Continued)

Primary Examiner — Richard E Chilcot

(57) **CLAIM**

The ornamental design for an air purifier, as shown and described.

DESCRIPTION

1. Air purifier
FIG. 1.1 is a perspective view showing my design;
FIG. 1.2 is a front elevational view thereof;
FIG. 1.3 is a rear elevational view thereof;
FIG. 1.4 is a right side elevational view thereof;
FIG. 1.5 is a left side elevational view thereof;
FIG. 1.6 is a top plan view thereof; and,
FIG. 1.7 is a bottom plan view thereof.

1 Claim, 7 Drawing Sheets

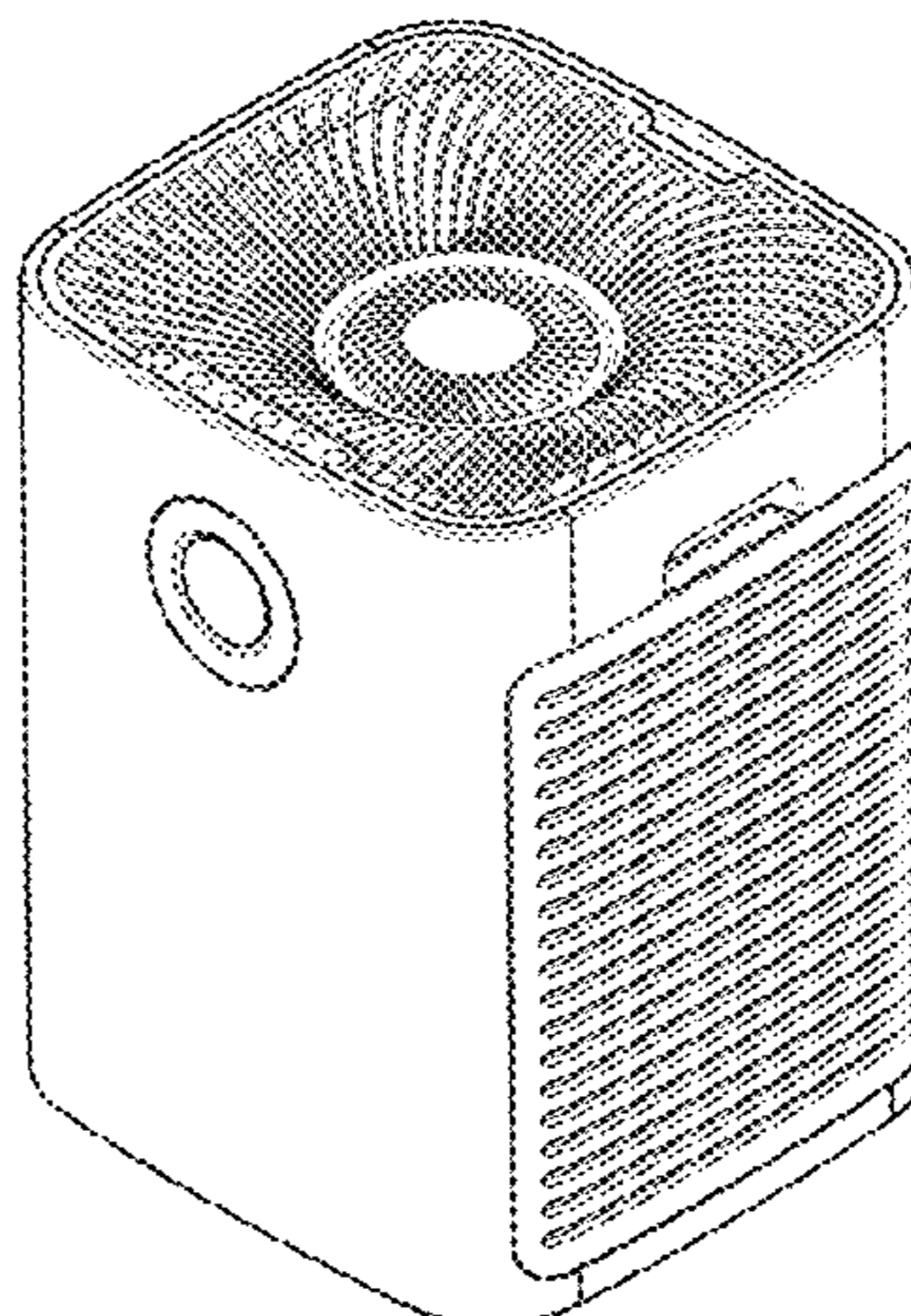

(56)

References Cited

U.S. PATENT DOCUMENTS

D818,095	S	*	5/2018	Cho	D23/364
D818,096	S	*	5/2018	Cho	D23/364
D818,097	S	*	5/2018	Cho	D23/364
D818,098	S	*	5/2018	Cho	D23/364
D818,099	S	*	5/2018	Cho	D23/364
D822,821	S	*	7/2018	Jonas	D23/385
D826,391	S	*	8/2018	Puffer	D23/371
D826,392	S	*	8/2018	Sinur	D23/372
D829,313	S	*	9/2018	Cho	D23/364
D829,314	S	*	9/2018	Cho	D23/364
D835,765	S	*	12/2018	Chen	D23/364
D835,766	S	*	12/2018	Chen	D23/364
D836,765	S	*	12/2018	Puffer	D23/370
D837,354	S	*	1/2019	Su	D23/364
D837,355	S	*	1/2019	Gunnfur	D23/364
D837,966	S	*	1/2019	Adrian	F24F 7/06 D23/412

* cited by examiner

1.1

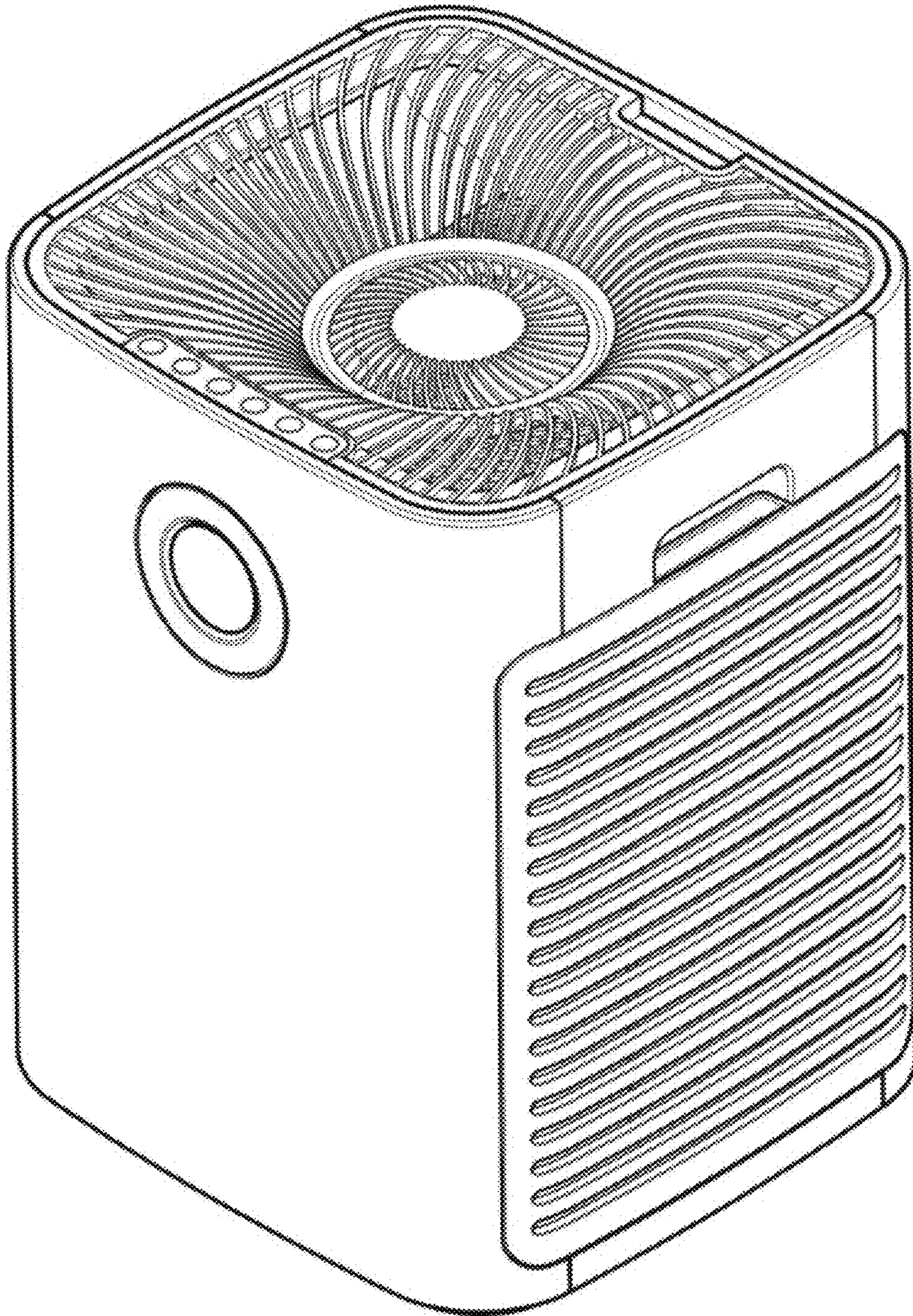

1.2

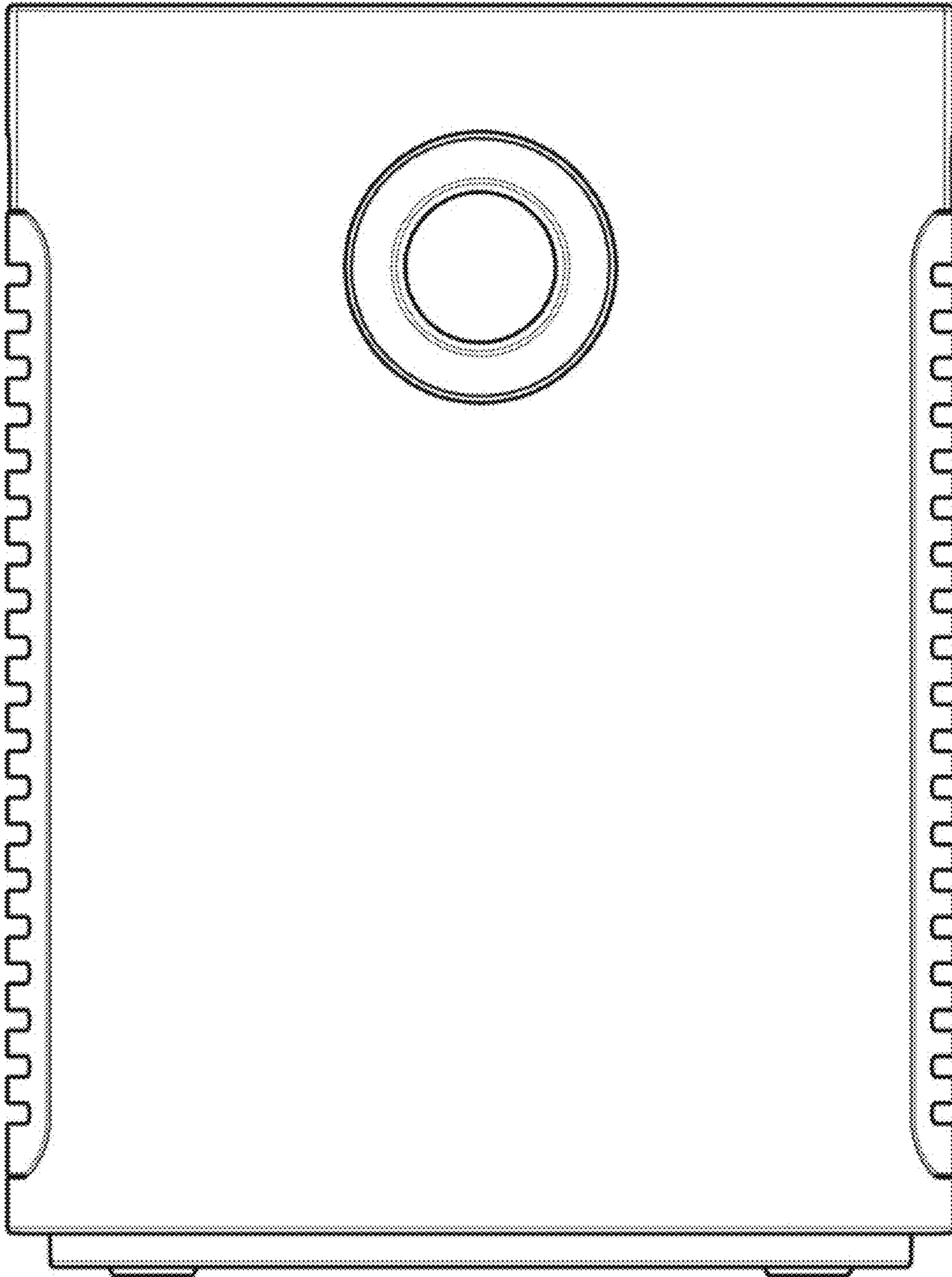

1.3

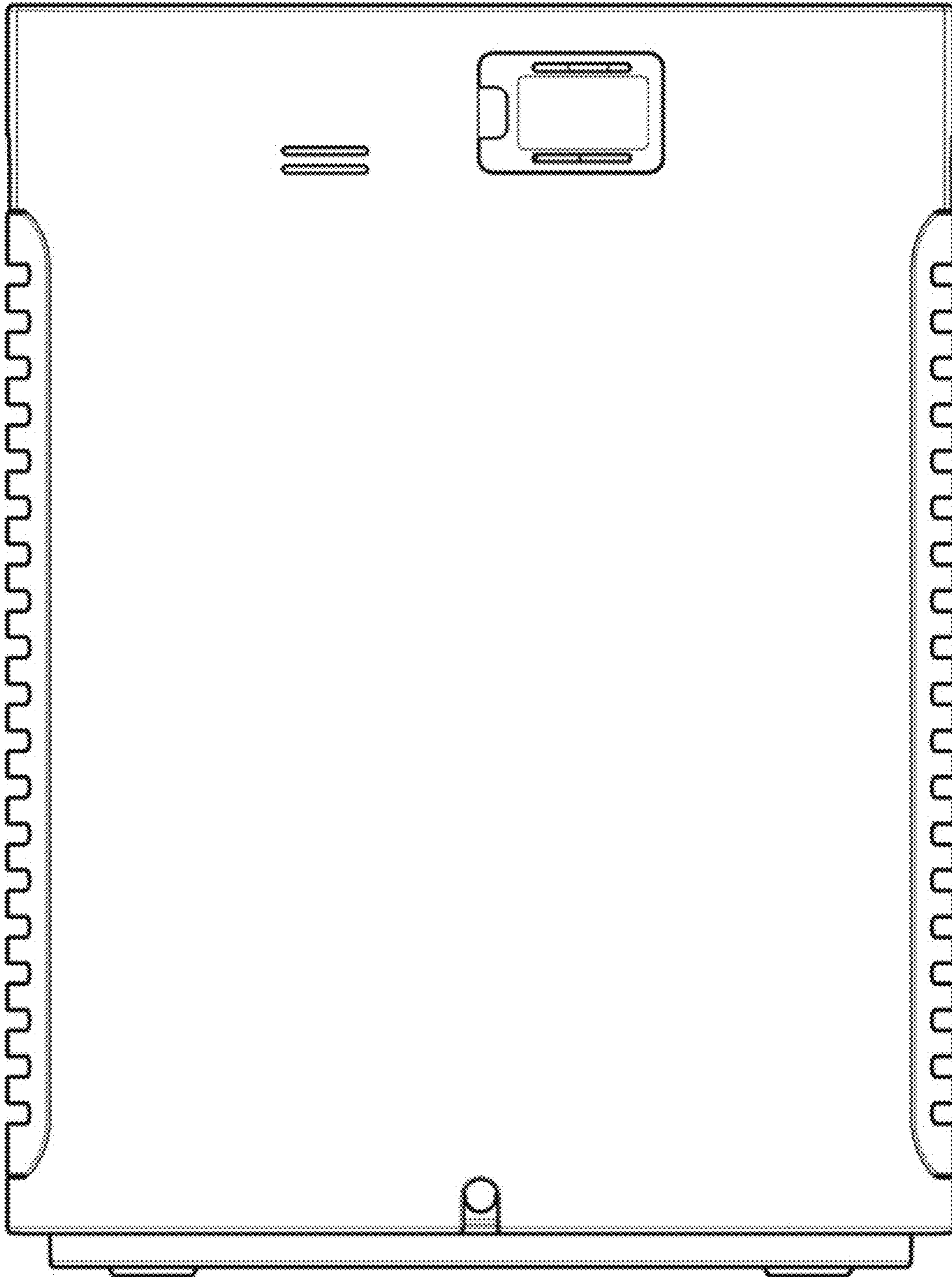

1.4

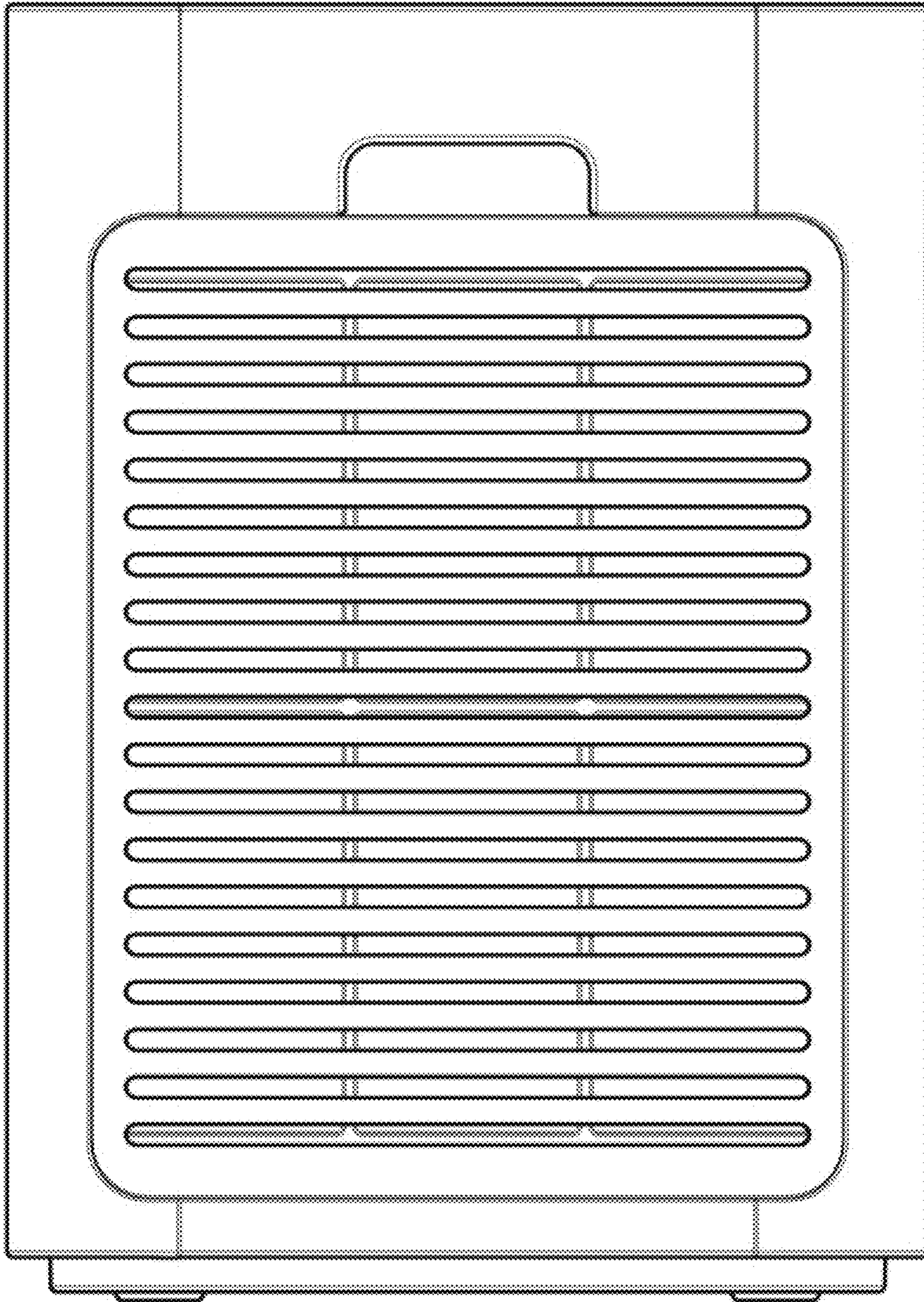

1.5

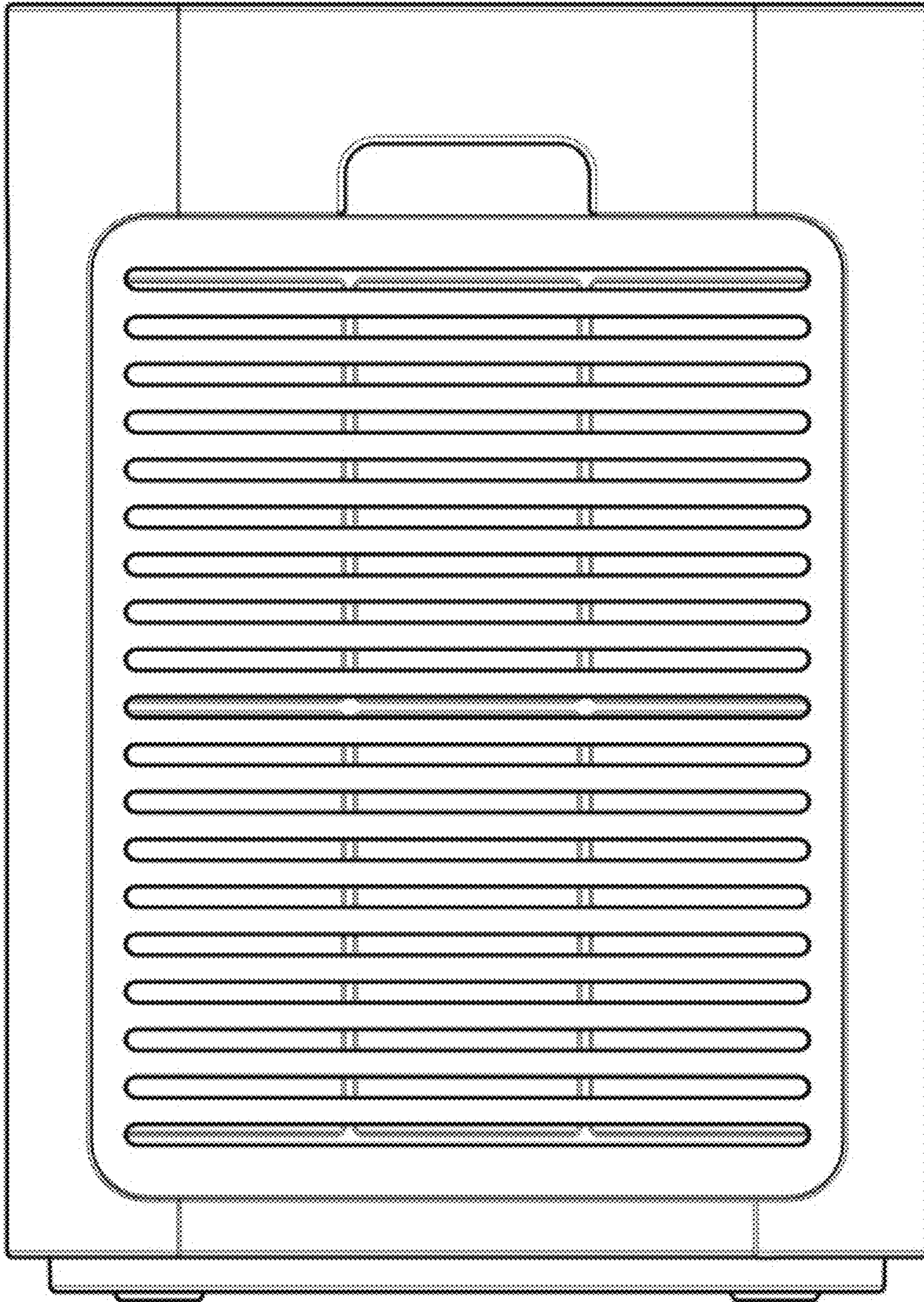

1.6

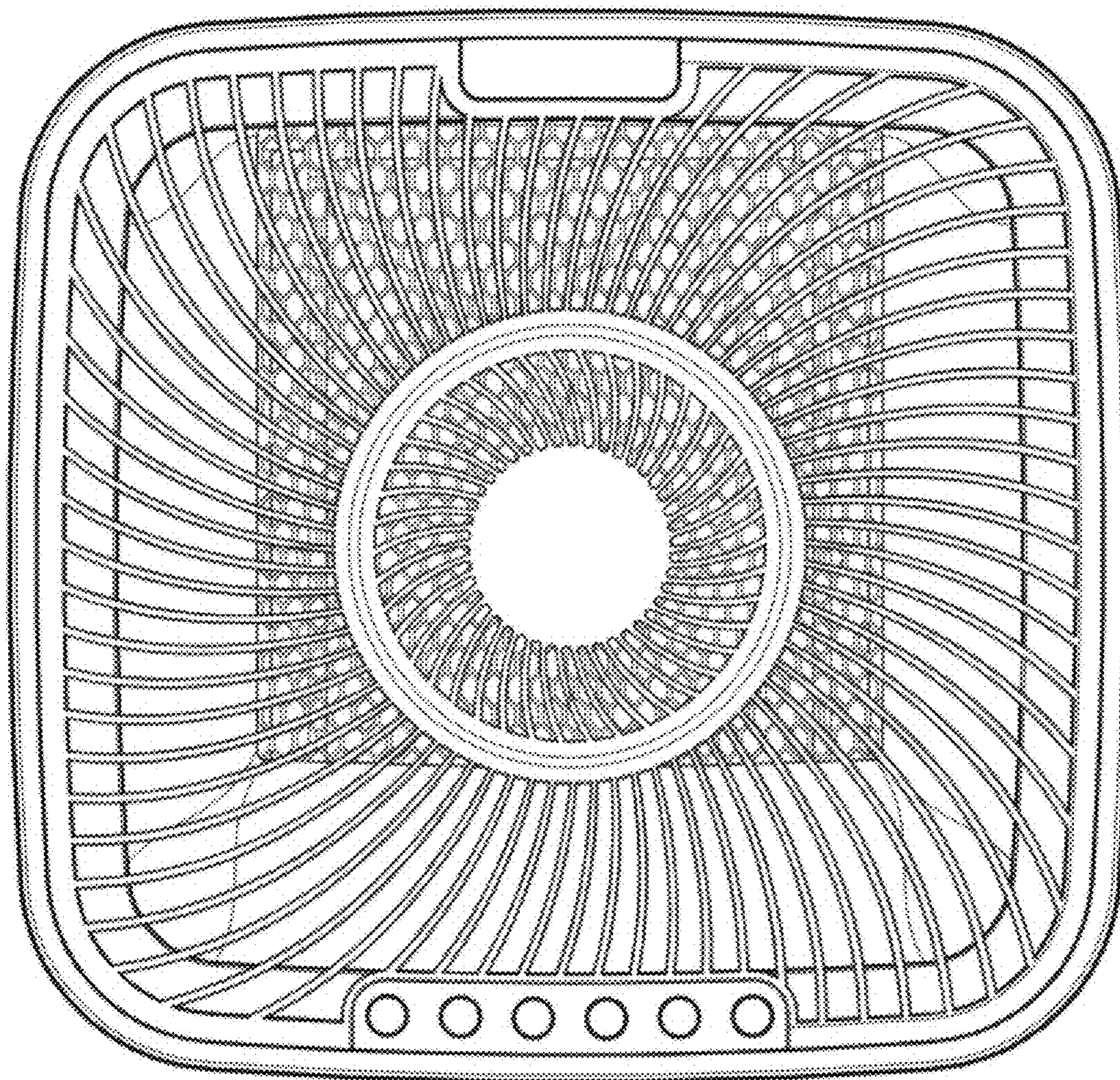

1.7

