



US00D852270S

(12) **United States Design Patent**
Sirichai

(10) **Patent No.:** **US D852,270 S**
(45) **Date of Patent:** **** Jun. 25, 2019**

(54) **IMPLEMENT HOLDER**
(71) Applicant: **Saharut Sirichai**, Bangkok (TH)
(72) Inventor: **Saharut Sirichai**, Bangkok (TH)
(73) Assignee: **WORLD RICHMAN**
MANUFACTURING
CORPORATION, Elgin, IL (US)

(**) Term: **15 Years**

(21) Appl. No.: **29/614,439**

(22) Filed: **Aug. 18, 2017**

(51) **LOC (11) Cl.** **19-06**

(52) **U.S. Cl.**
USPC **D19/81**

(58) **Field of Classification Search**
USPC D19/32, 75, 77-85, 135; D3/315, 901;
D6/677.3; D7/590, 641; D9/415, 457,
D9/722; D28/73

CPC .. B43K 23/001; B43K 23/002; B43K 23/004;
B43K 23/008; B43K 23/012; B43K
23/016; B43K 23/04; B43M 99/006;
B43M 99/008

See application file for complete search history.

(56) **References Cited**

U.S. PATENT DOCUMENTS

1,226,992 A * 5/1917 Paulus F16B 21/183
24/1
1,286,551 A * 12/1918 Davis A45D 40/02
401/82
1,840,563 A * 1/1932 Brosius, Jr. B43K 23/001
24/11 CT
1,919,133 A * 7/1933 Rolot A45D 40/023
401/59
2,300,216 A * 10/1942 Grodsky B42D 9/005
116/237

2,553,346 A * 5/1951 Wing B43K 23/001
24/11 CT
2,867,363 A * 1/1959 Knemmerling B23Q 13/00
206/349
3,283,421 A * 11/1966 Schott G09B 3/04
24/67.9
D269,625 S * 7/1983 Draddy D19/26
D284,481 S * 7/1986 Draddy D19/26
D298,892 S * 12/1988 Chinchar D19/86
4,984,529 A * 1/1991 Dickson B42D 9/007
116/234
5,501,171 A * 3/1996 Leake B42D 9/004
116/234
5,572,941 A * 11/1996 Arnos A47B 21/0371
112/475.06

(Continued)

Primary Examiner — Elizabeth A. Albert

(74) *Attorney, Agent, or Firm* — Christopher J. Scott

(57) **CLAIM**

The ornamental design for the implement holder, as shown and described.

DESCRIPTION

FIG. 1 is a front view of the implement holder showing my new design;
FIG. 2 is a rear view thereof;
FIG. 3 is a right side view thereof;
FIG. 4 is a left side view thereof;
FIG. 5 is a perspective view thereof;
FIG. 6 is another perspective view thereof;
FIG. 7 is a top plan view thereof;
FIG. 8 is a bottom plan view thereof;
FIG. 9 is a right side view thereof in use;
FIG. 10 is a front view thereof in use; and,
FIG. 11 is still another perspective view thereof on a reduced scale in another condition of use.
The broken lines are included for the purpose of showing environmental subject matter and form no part of the claimed design.

1 Claim, 6 Drawing Sheets

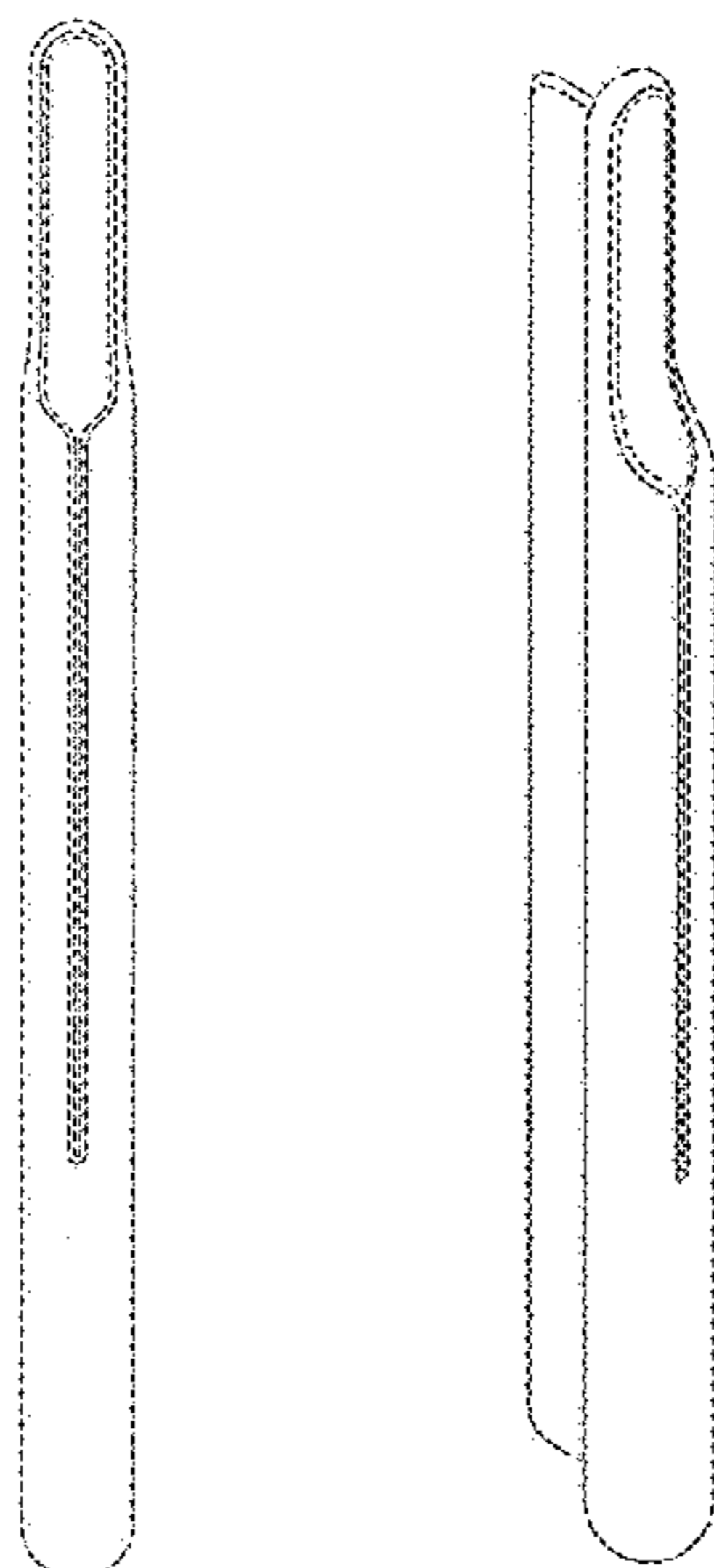

(56)

References Cited

U.S. PATENT DOCUMENTS

5,813,786 A * 9/1998 Fraenkel B43K 23/001
24/10 R
5,881,434 A * 3/1999 Rigney B43K 23/001
24/11 R
D438,564 S * 3/2001 Green D19/135
D479,477 S * 9/2003 Perczon D10/74
7,270,308 B1 * 9/2007 Mohr B43K 23/02
248/309.1
D573,652 S * 7/2008 Esfahani D19/81
D598,052 S * 8/2009 Esfahani D19/81
D603,904 S * 11/2009 Esfahani D19/81
D764,912 S * 8/2016 Houyoux D28/73
D794,120 S * 8/2017 Takemura D19/81
D818,641 S * 5/2018 Wilson D28/7

* cited by examiner

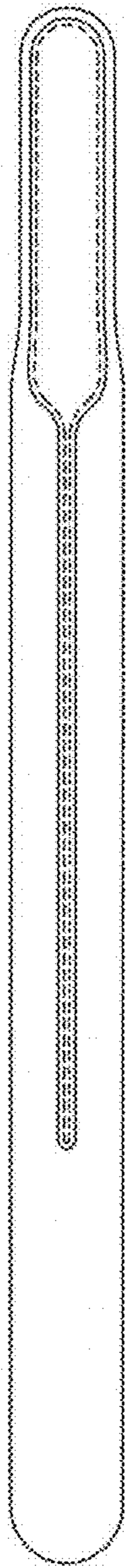

FIG. 1

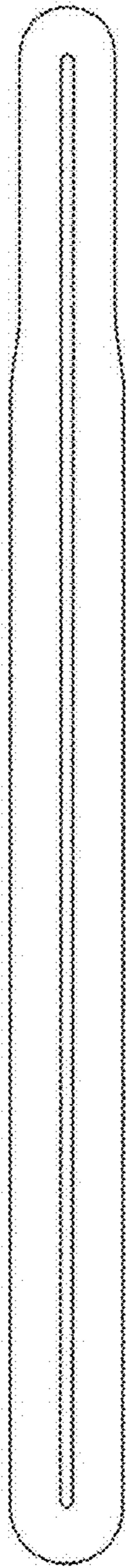

FIG. 2

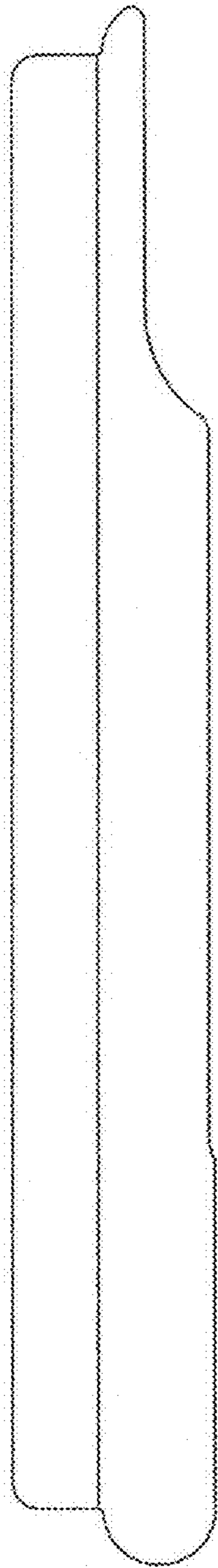

FIG.3

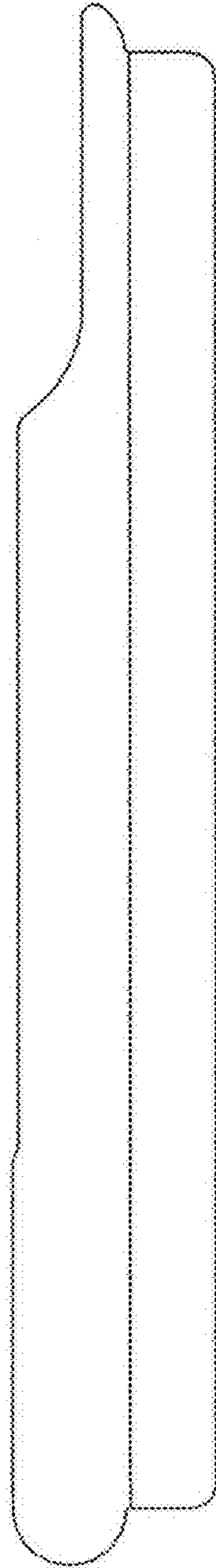

FIG.4

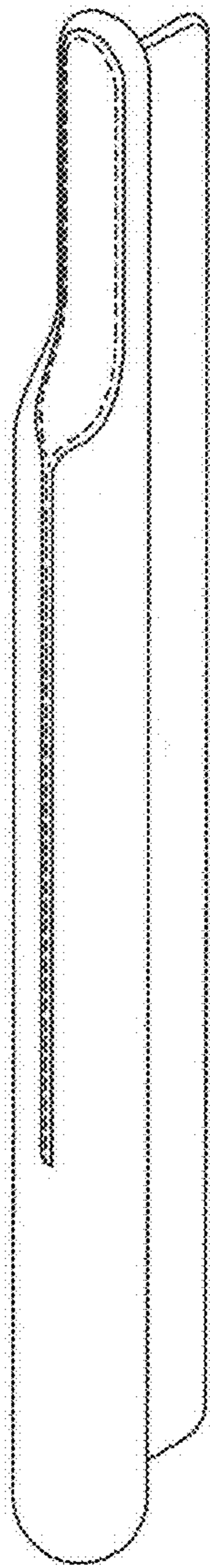

FIG. 5

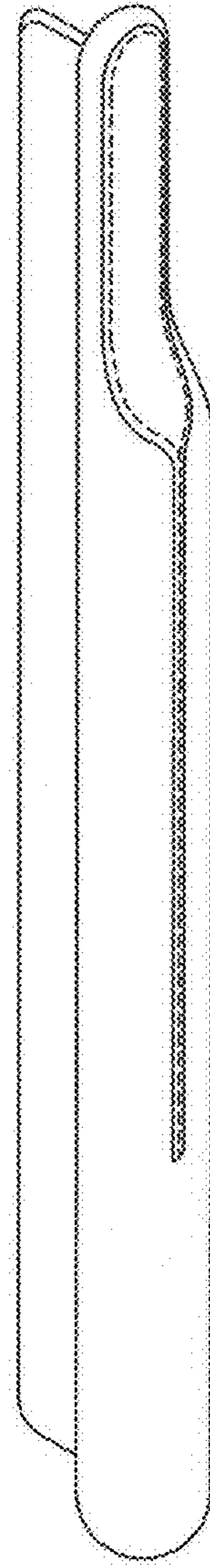

FIG. 6

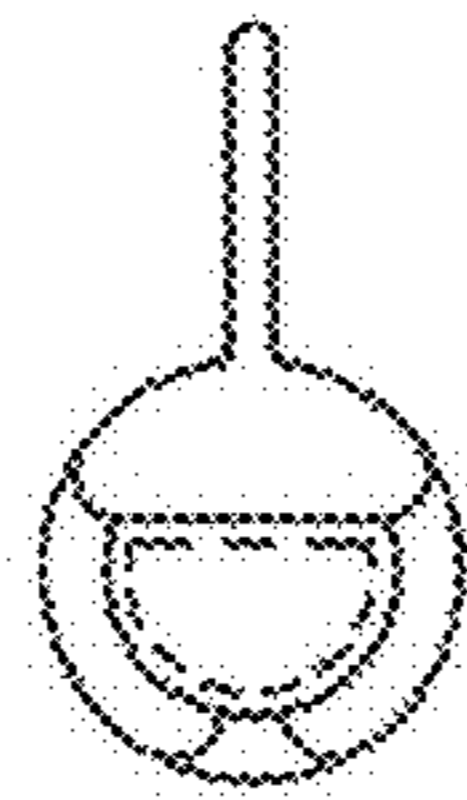

FIG. 7

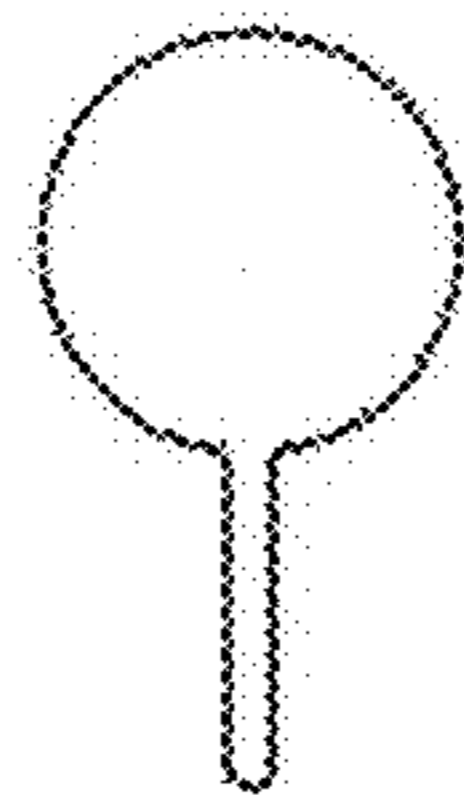

FIG. 8

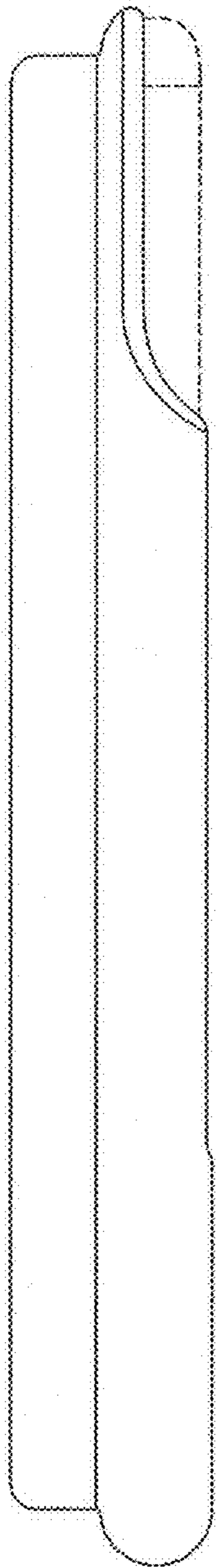

FIG. 9

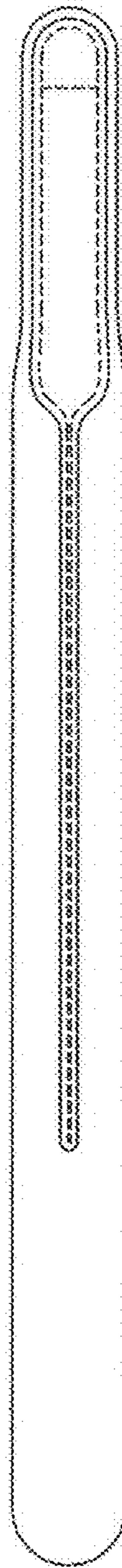

FIG. 10

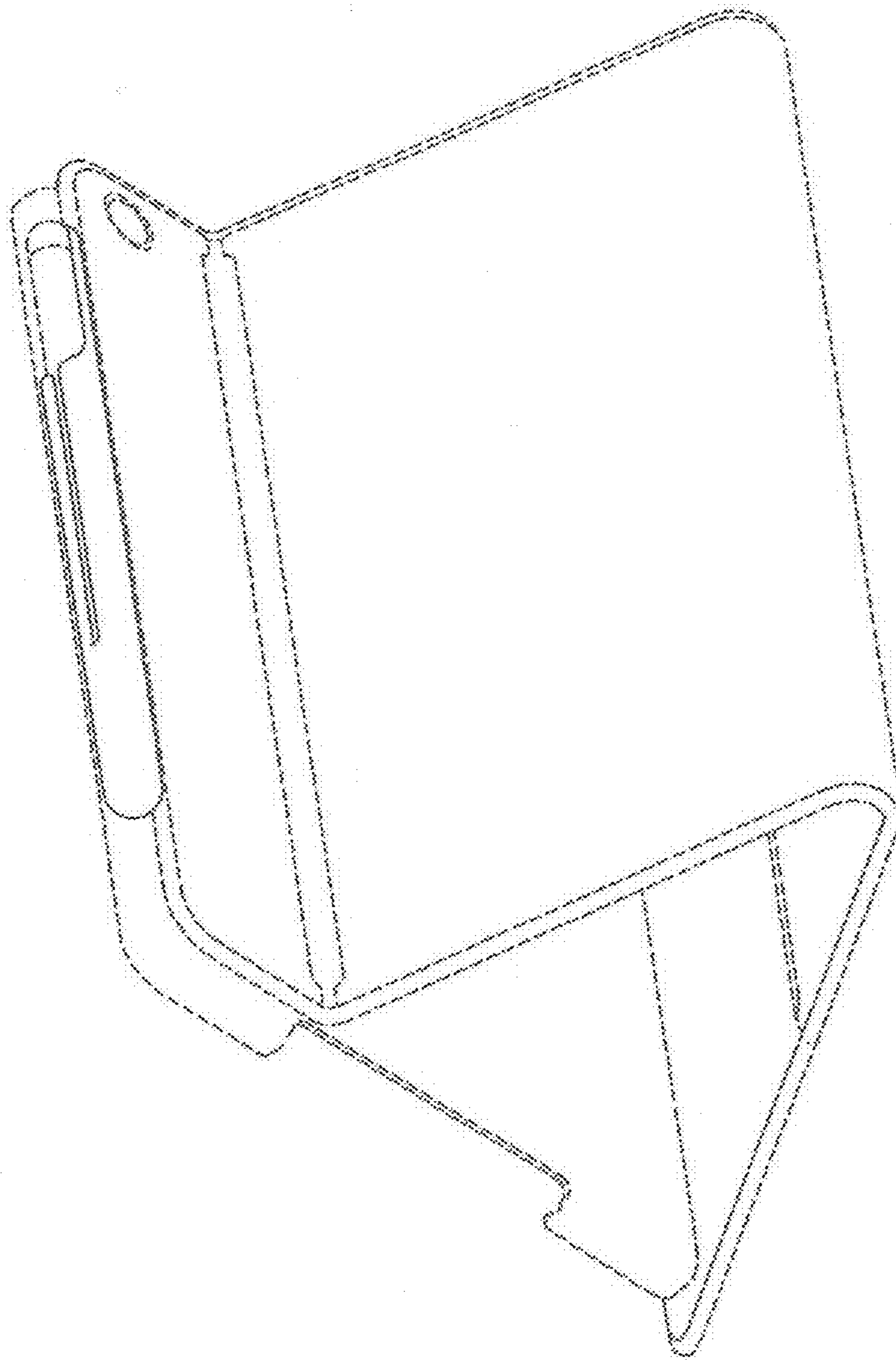

FIG. 11