



US00D852235S

(12) **United States Design Patent**
Broen et al.

(10) **Patent No.:** **US D852,235 S**
(45) **Date of Patent:** **** Jun. 25, 2019**

(54) **COOLER**

(71) Applicant: **PepsiCo, Inc.**, Purchase, NY (US)

(72) Inventors: **Martin Eduardo Broen**, New York, NY (US); **Stephen Lim**, Chappaqua, NY (US); **Christian Stolarz**, Brooklyn, NY (US); **David Jennings Lucas**, Austin, TX (US); **Salvatore Michael Primo**, Austin, TX (US)

(73) Assignee: **PepsiCo, Inc.**, Purchase, NY (US)

(**) Term: **15 Years**

(21) Appl. No.: **29/618,832**

(22) Filed: **Sep. 25, 2017**

Related U.S. Application Data

(63) Continuation of application No. 29/598,961, filed on Mar. 30, 2017, now Pat. No. Des. 799,565, and a continuation of application No. 29/586,252, filed on Dec. 1, 2016, now Pat. No. Des. 799,566, which is a continuation of application No. 29/539,858, filed on Sep. 17, 2015, now Pat. No. Des. 787,565, and a continuation of application No. 29/539,858, filed on Sep. 17, 2015, now Pat. No. Des. 787,565.

(51) **LOC (11) Cl.** **15-07**

(52) **U.S. Cl.**
USPC **D15/89**

(58) **Field of Classification Search**
USPC D15/79-91
CPC .. F25D 11/00; F25D 17/065; F25D 2325/022;
F25D 23/069; F25D 25/025; F25D 11/02;
F25D 17/062; F25D 21/12; F25D 21/125;
F25D 21/14; F25D 2317/061; F25D
2317/067; F25D 2323/021; F25D
2323/024; F25D 23/028; F25D 23/04;
F25D 23/066; F25D 23/085; F25D
23/087; F25D 23/126; F25D 2400/02;
F25D 2400/06; F25D 2400/361; F25D

2400/40; F25D 25/005; F25D 25/02;
F25D 2600/02; F25D 2700/02; F25D
2700/12; F25D 2700/121; F25D 2700/14;
F25D 29/00

See application file for complete search history.

(56) **References Cited**

U.S. PATENT DOCUMENTS

D421,534 S 3/2000 Trulaske, Sr. et al.
D519,528 S 4/2006 Reese
D520,030 S 5/2006 Reese et al.
(Continued)

Primary Examiner — Khawaja Anwar

(74) *Attorney, Agent, or Firm* — Sterne, Kessler,
Goldstein & Fox P.L.L.C.

(57) **CLAIM**

The ornamental design for a cooler, as shown and described.

DESCRIPTION

FIG. 1 is a top front perspective view of a cooler showing the claimed design;
FIG. 2 is a front view thereof;
FIG. 3 is a rear view thereof;
FIG. 4 is a left side view thereof;
FIG. 5 is a right side view thereof;
FIG. 6 is a top view thereof;
FIG. 7 is a bottom view thereof;
FIG. 8 is a top front perspective view of a cooler showing the claimed design;
FIG. 9 is a front view thereof;
FIG. 10 is a rear view thereof;
FIG. 11 is a left side view thereof;
FIG. 12 is a right side view thereof;
FIG. 13 is a top view thereof; and,
FIG. 14 is a bottom view thereof.
The broken lines in the figures show portions of the cooler that form no part of the claimed design.

1 Claim, 14 Drawing Sheets

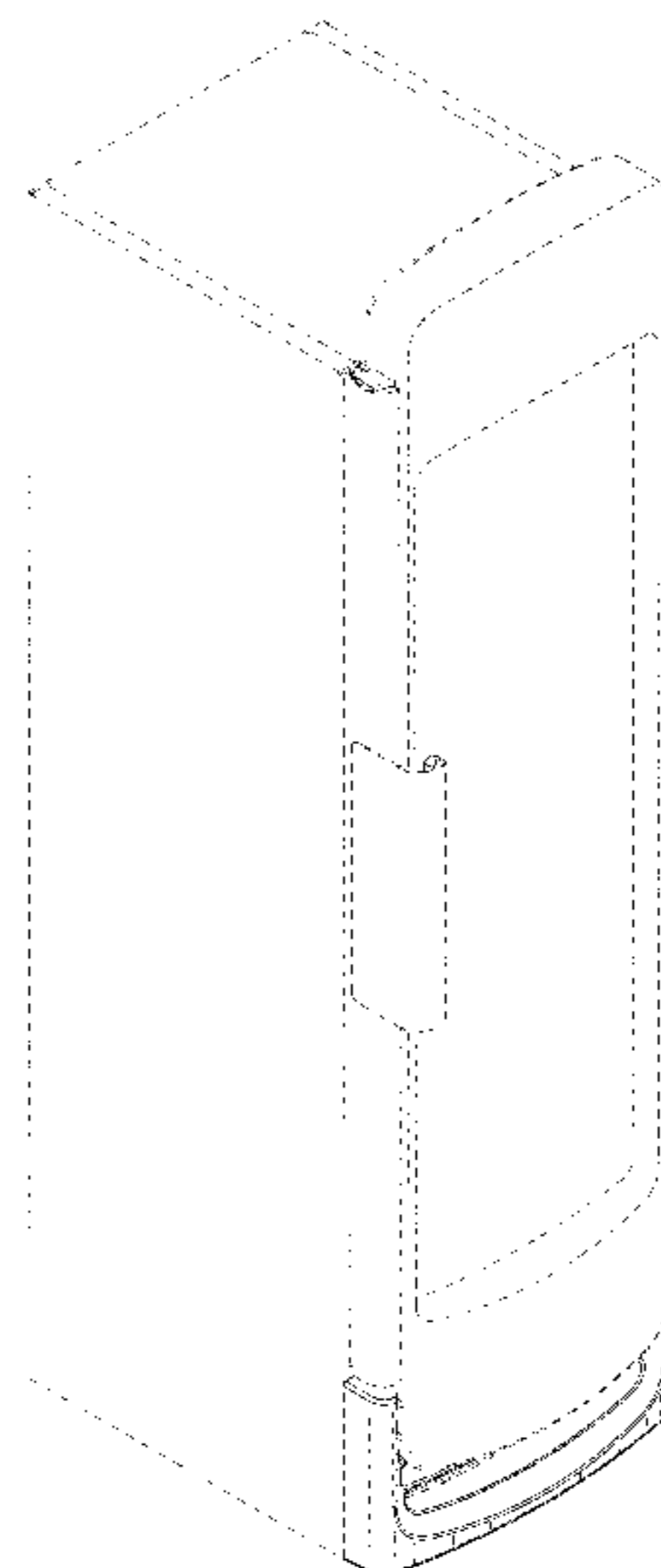
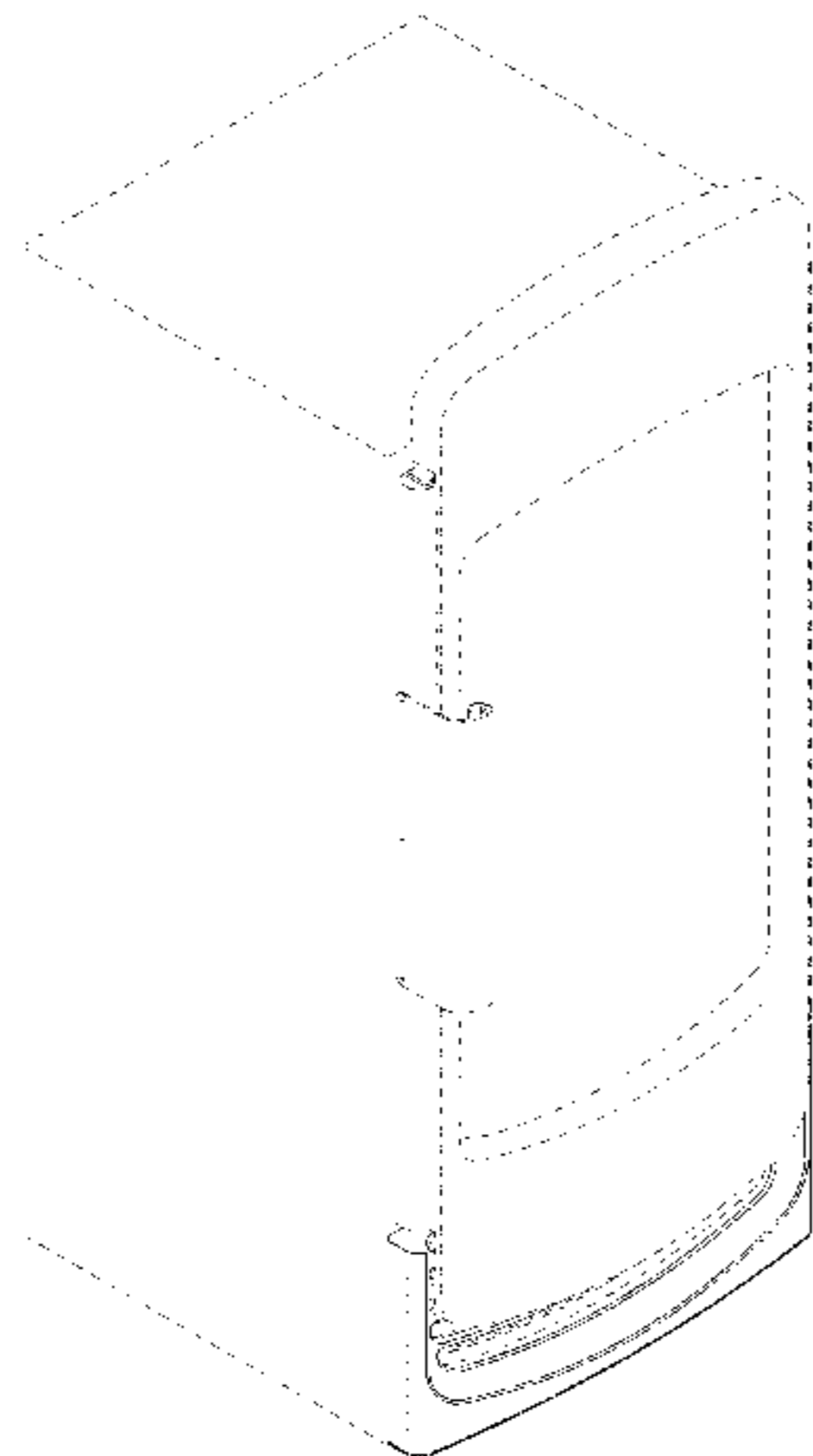

(56)

References Cited

U.S. PATENT DOCUMENTS

D520,532 S *	5/2006	Reese	D15/89
D520,533 S *	5/2006	Reese	D15/89
D524,830 S *	7/2006	Lei	D15/81
D541,315 S	4/2007	Trulaske, Sr.	
D571,828 S *	6/2008	Braun	D15/89
D573,612 S *	7/2008	Braun	D15/89
D573,613 S *	7/2008	Braun	D15/89
D613,315 S *	4/2010	Crookshanks	D15/89
D671,576 S *	11/2012	Jafa	D15/91
D746,879 S *	1/2016	Stolarz	D15/81
D787,565 S *	5/2017	Broen	D15/81
D799,565 S *	10/2017	Broen	D15/81
D799,566 S *	10/2017	Broen	D15/89
D803,277 S *	11/2017	Stolarz	D15/81

* cited by examiner

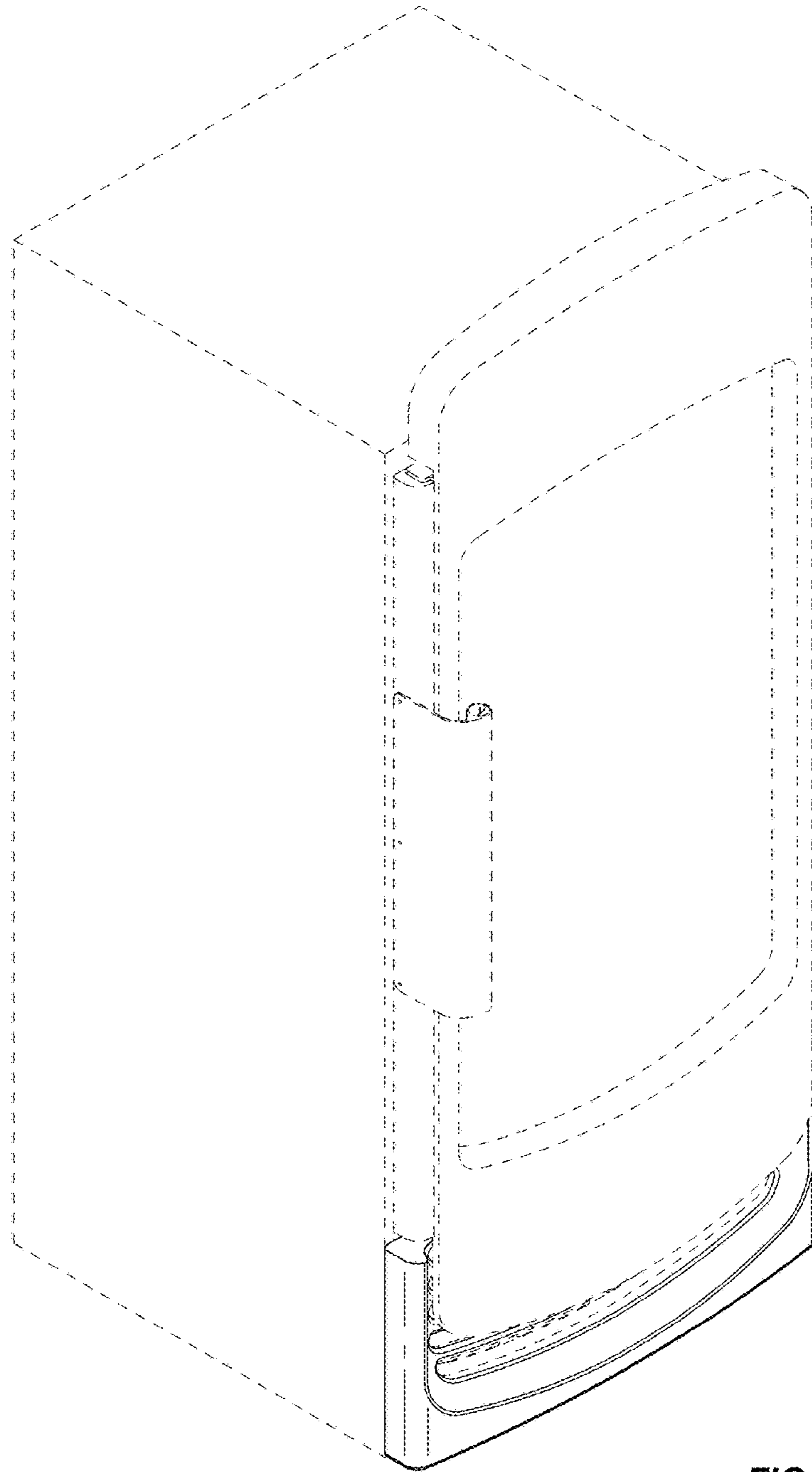

FIG. 1

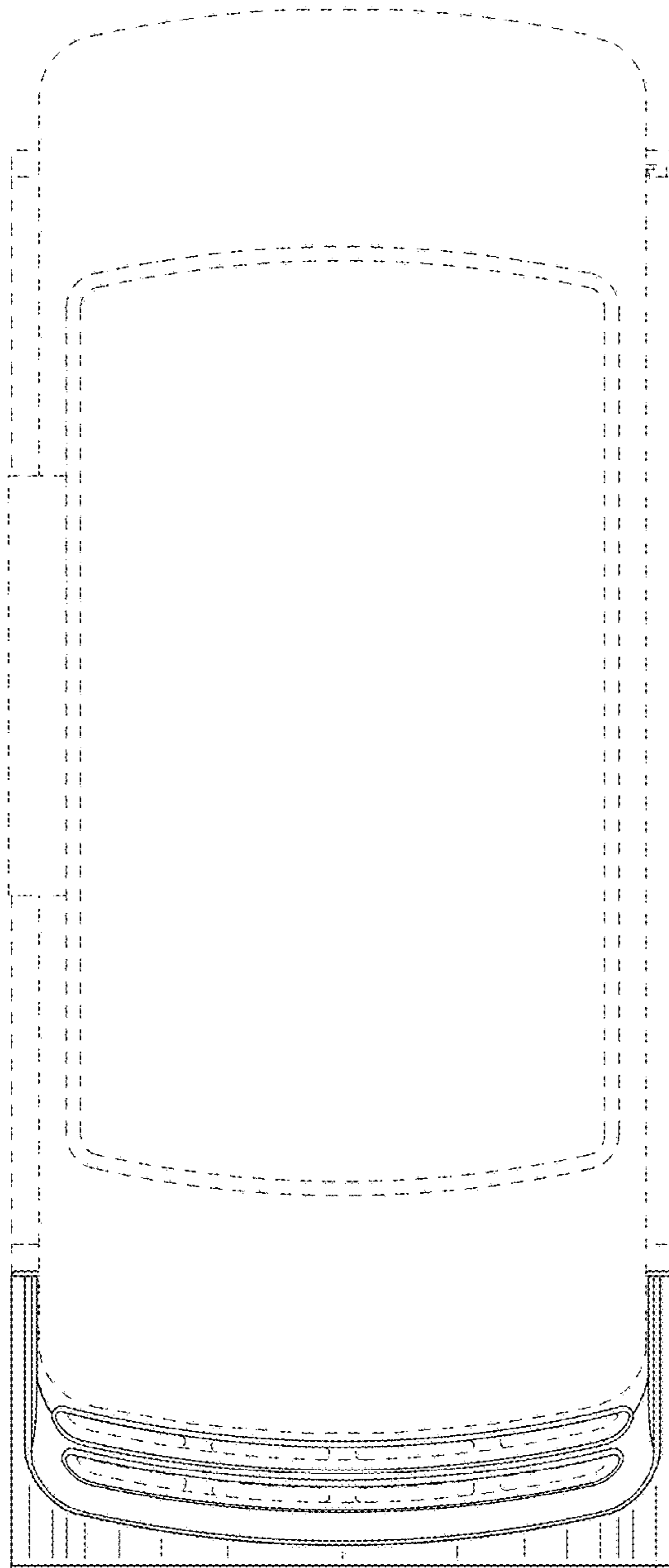

FIG. 2

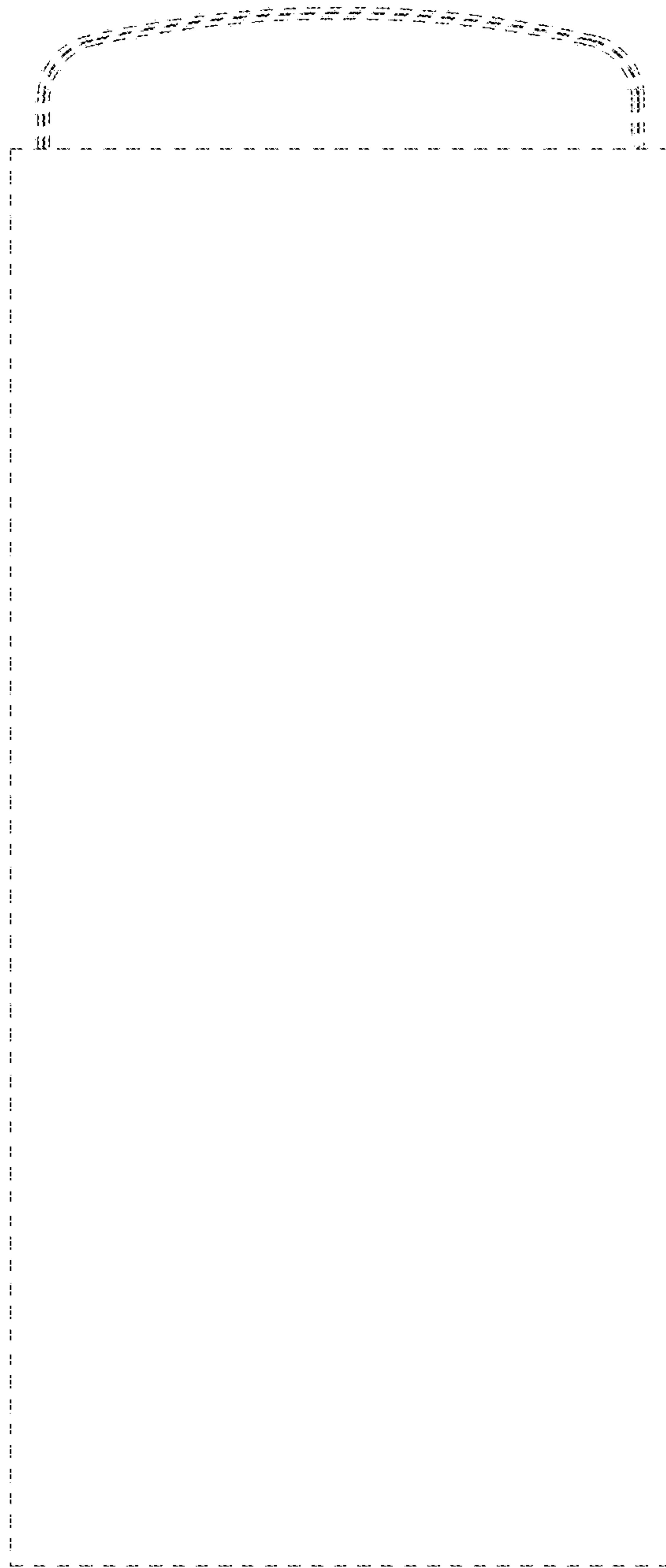

FIG. 3

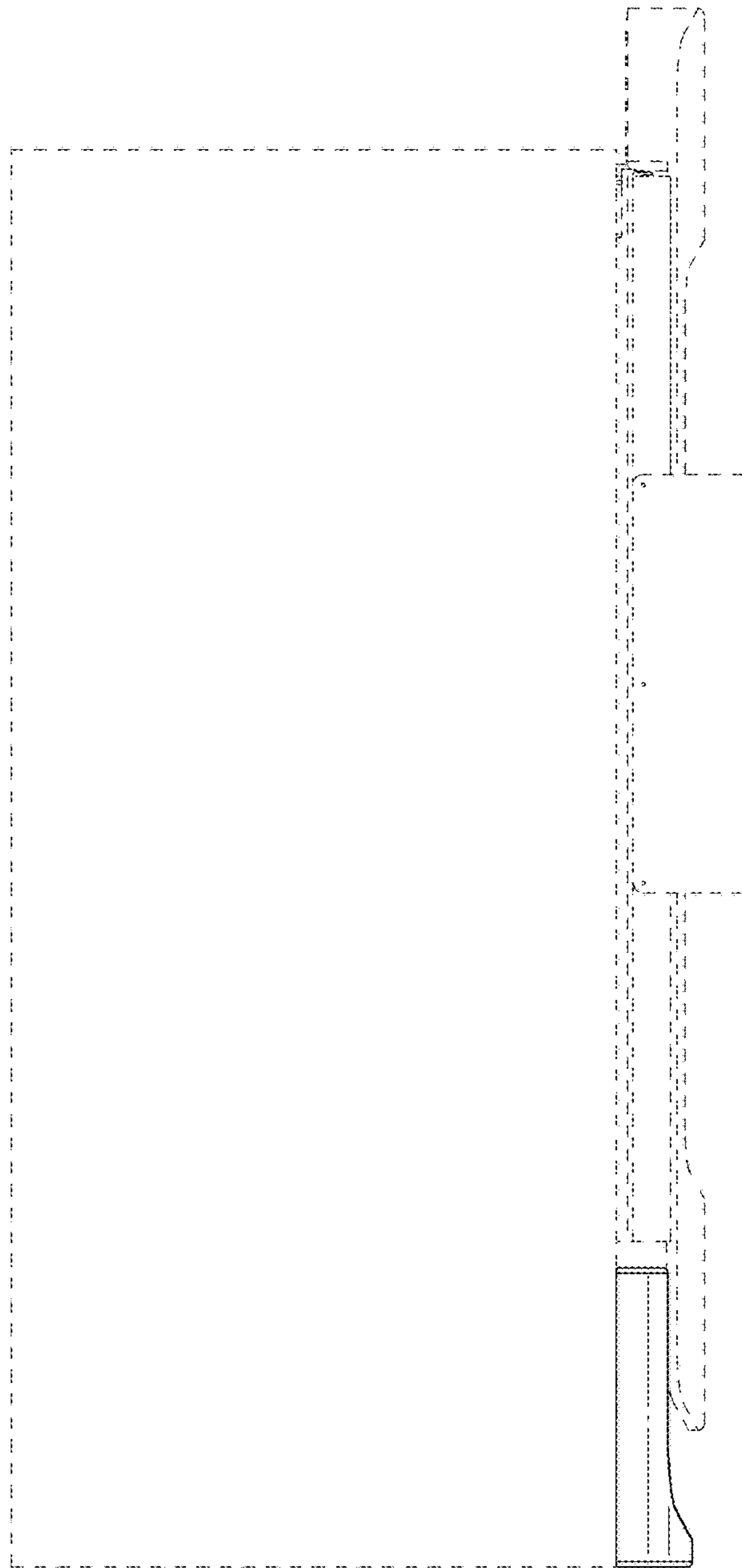

FIG. 4

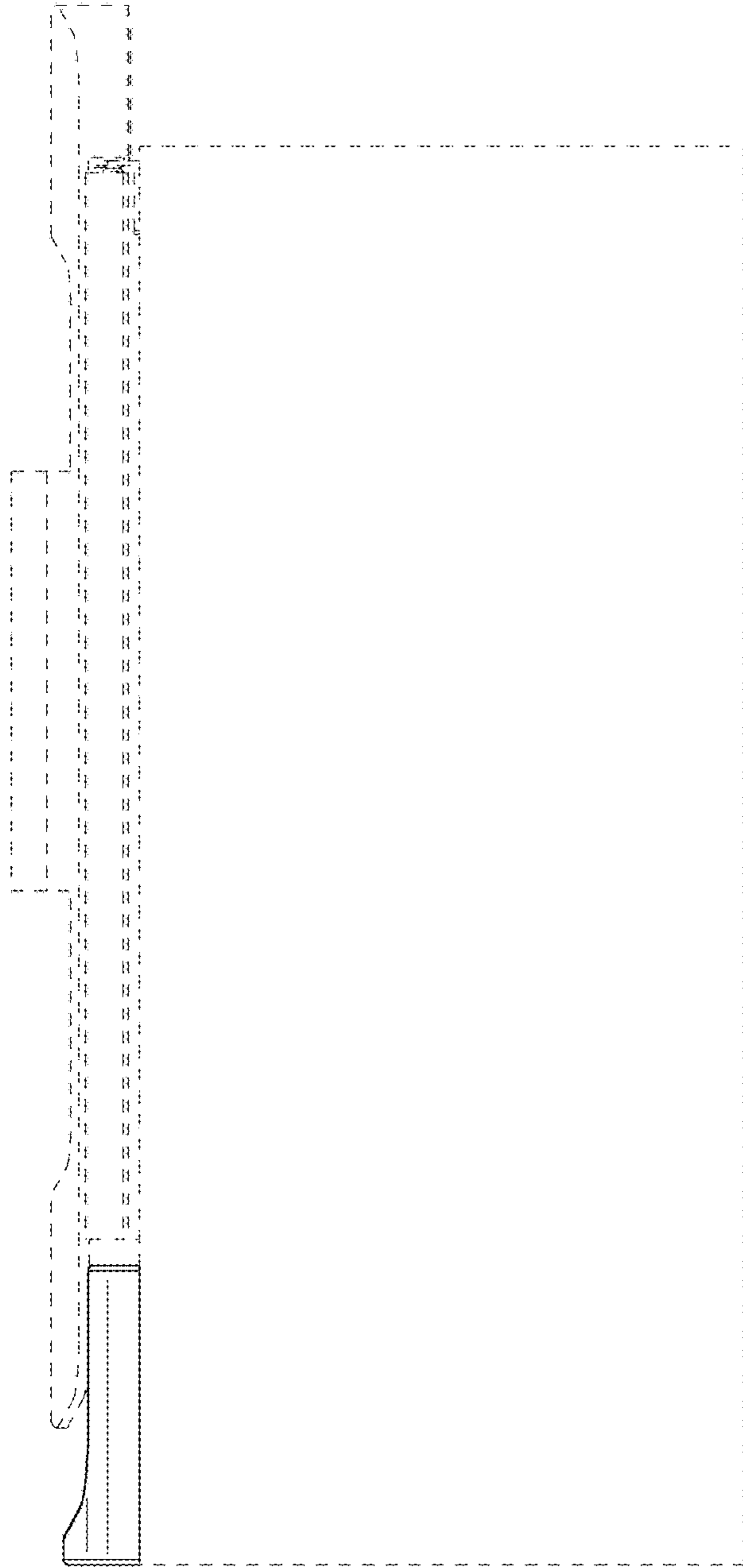

FIG. 5

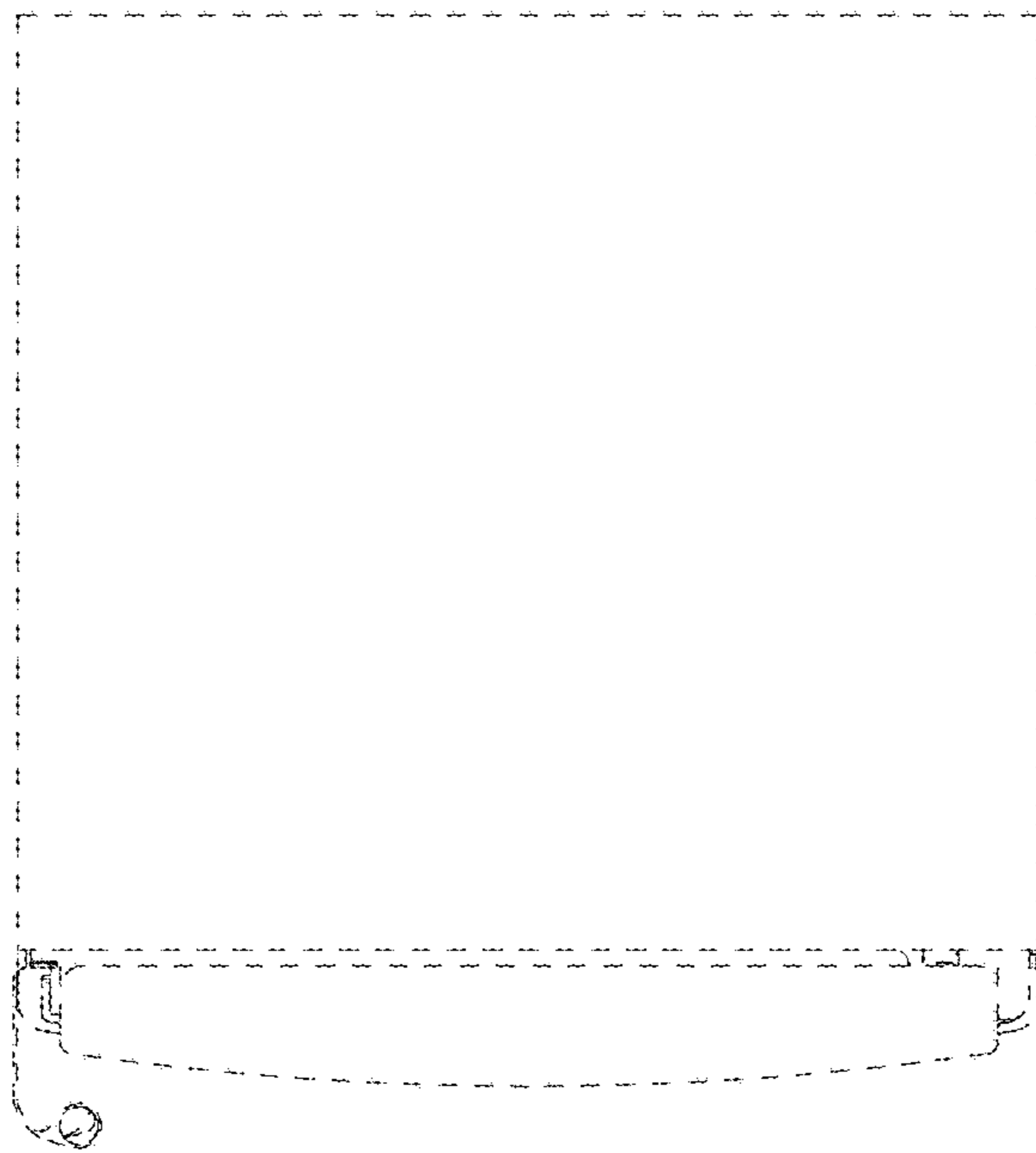

FIG. 6

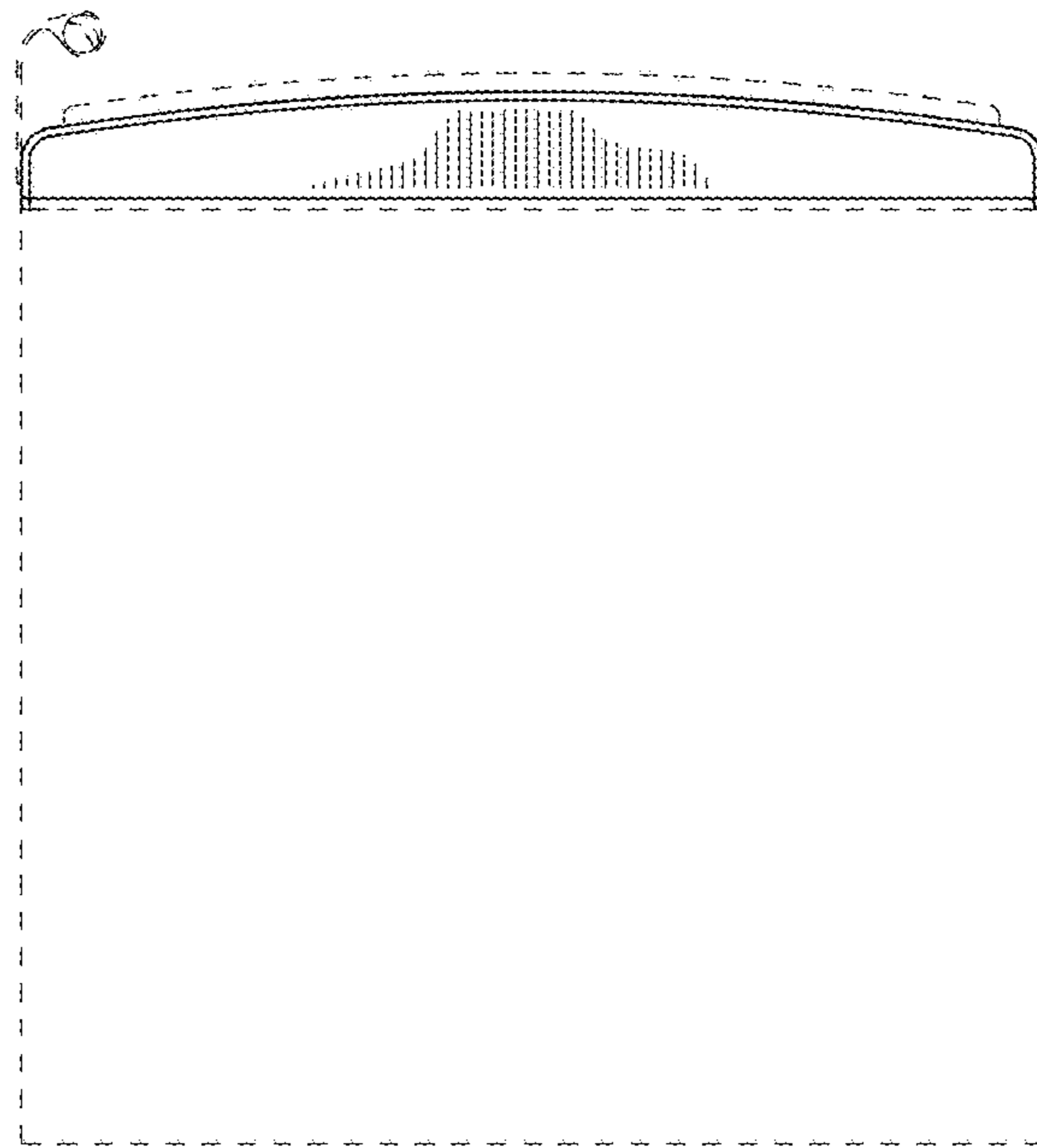

FIG. 7

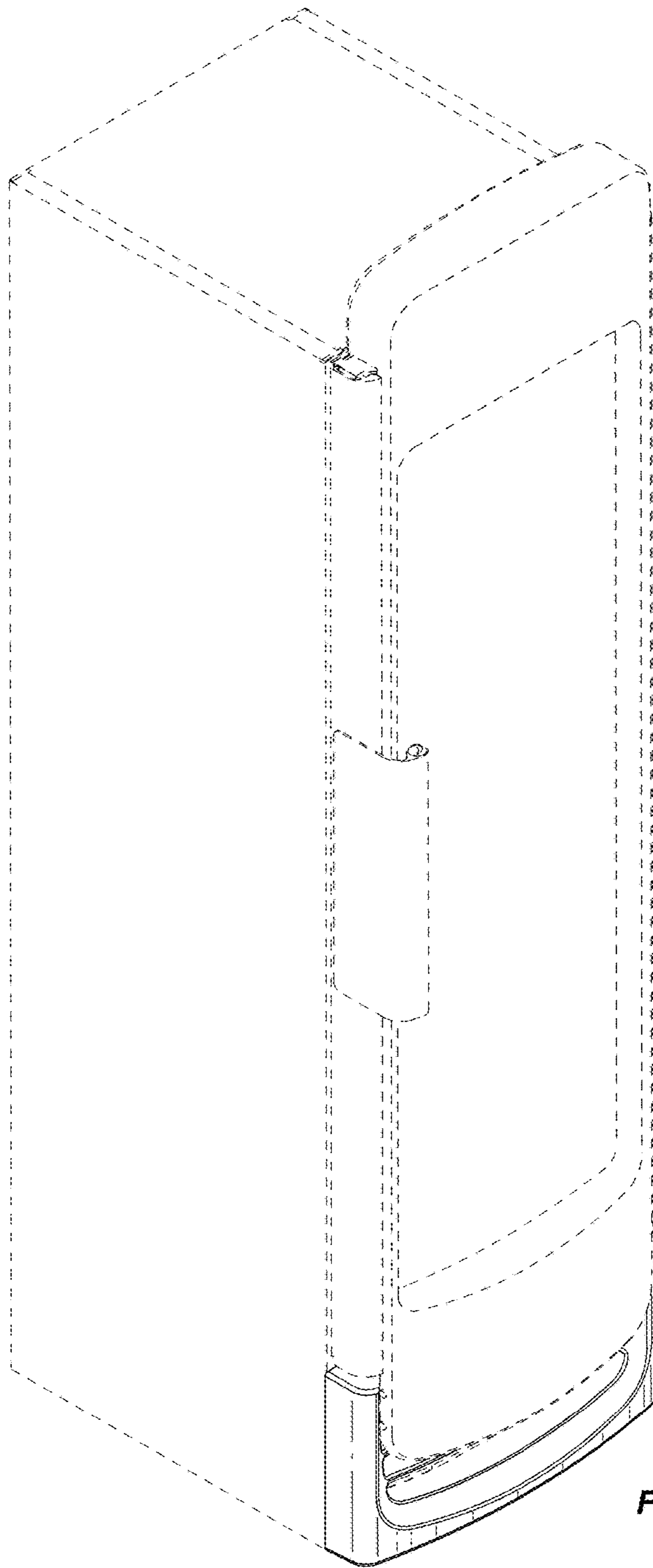

FIG. 8

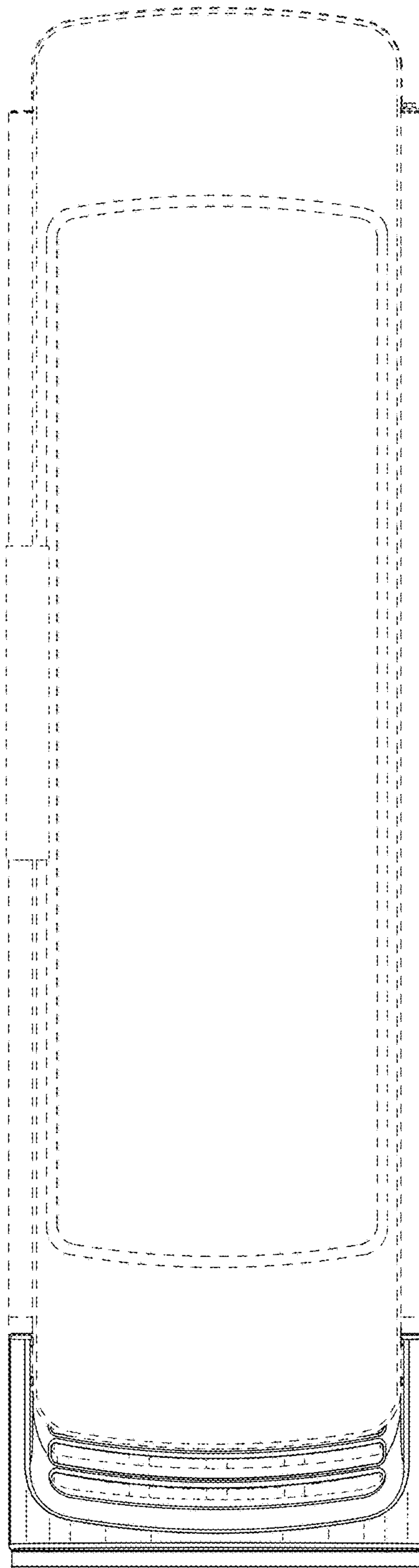

FIG. 9

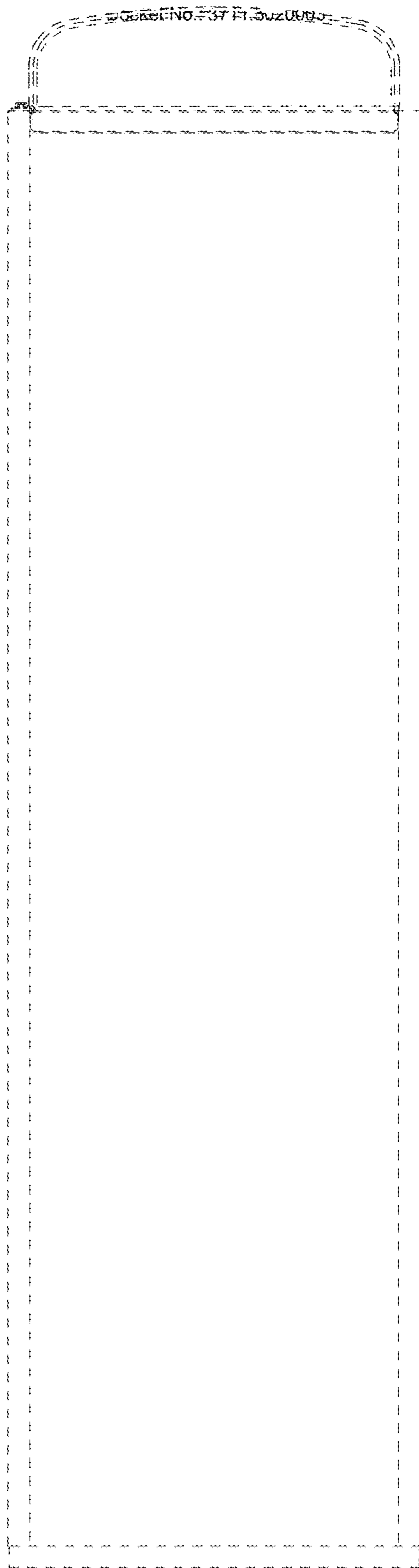

FIG. 10

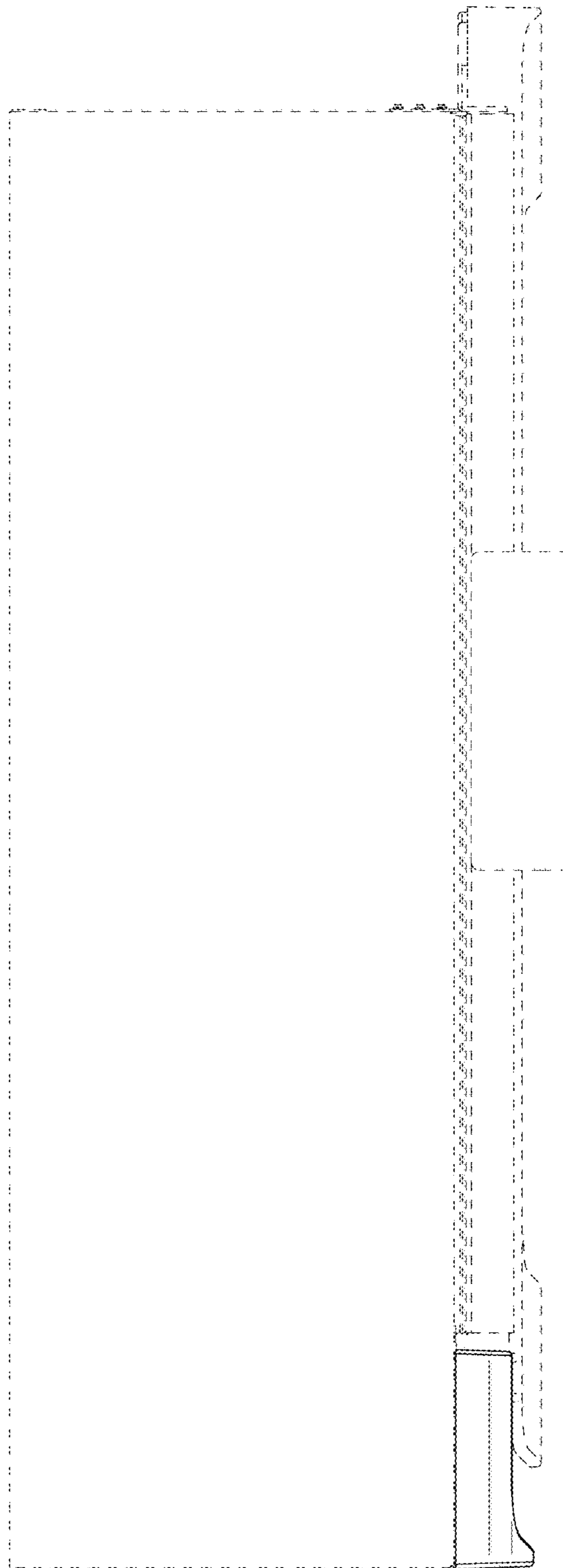

FIG. 11

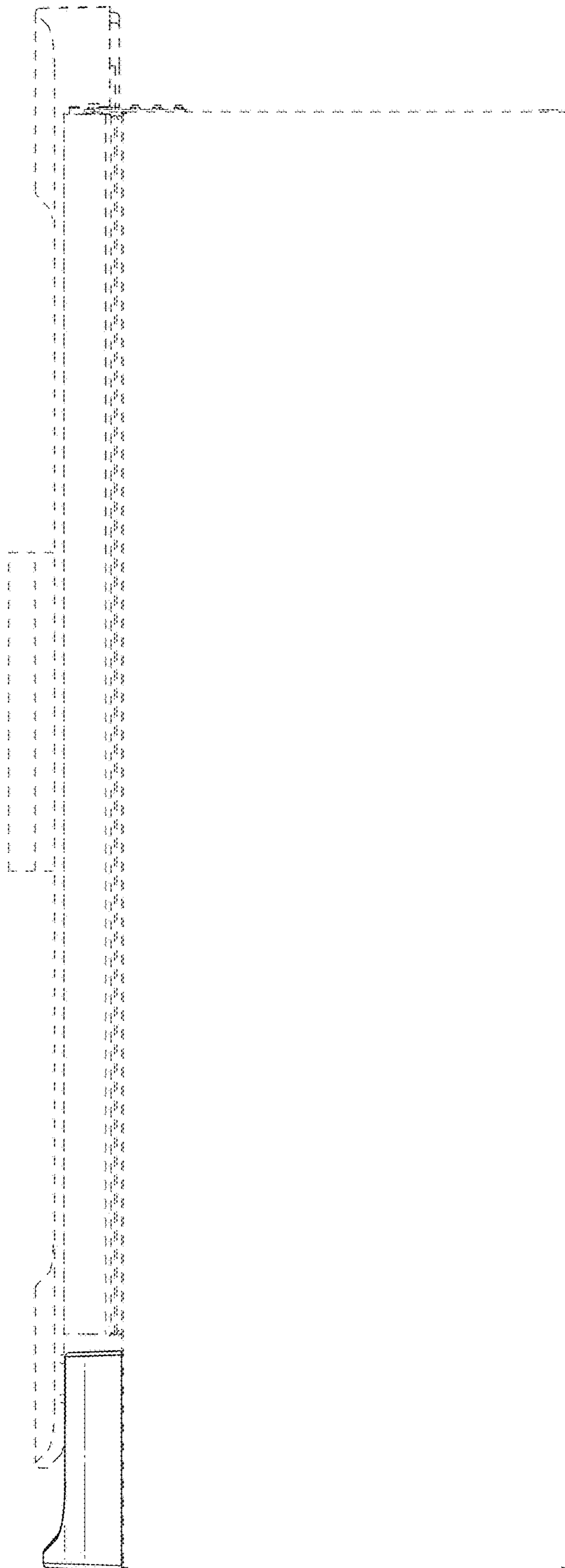

FIG. 12

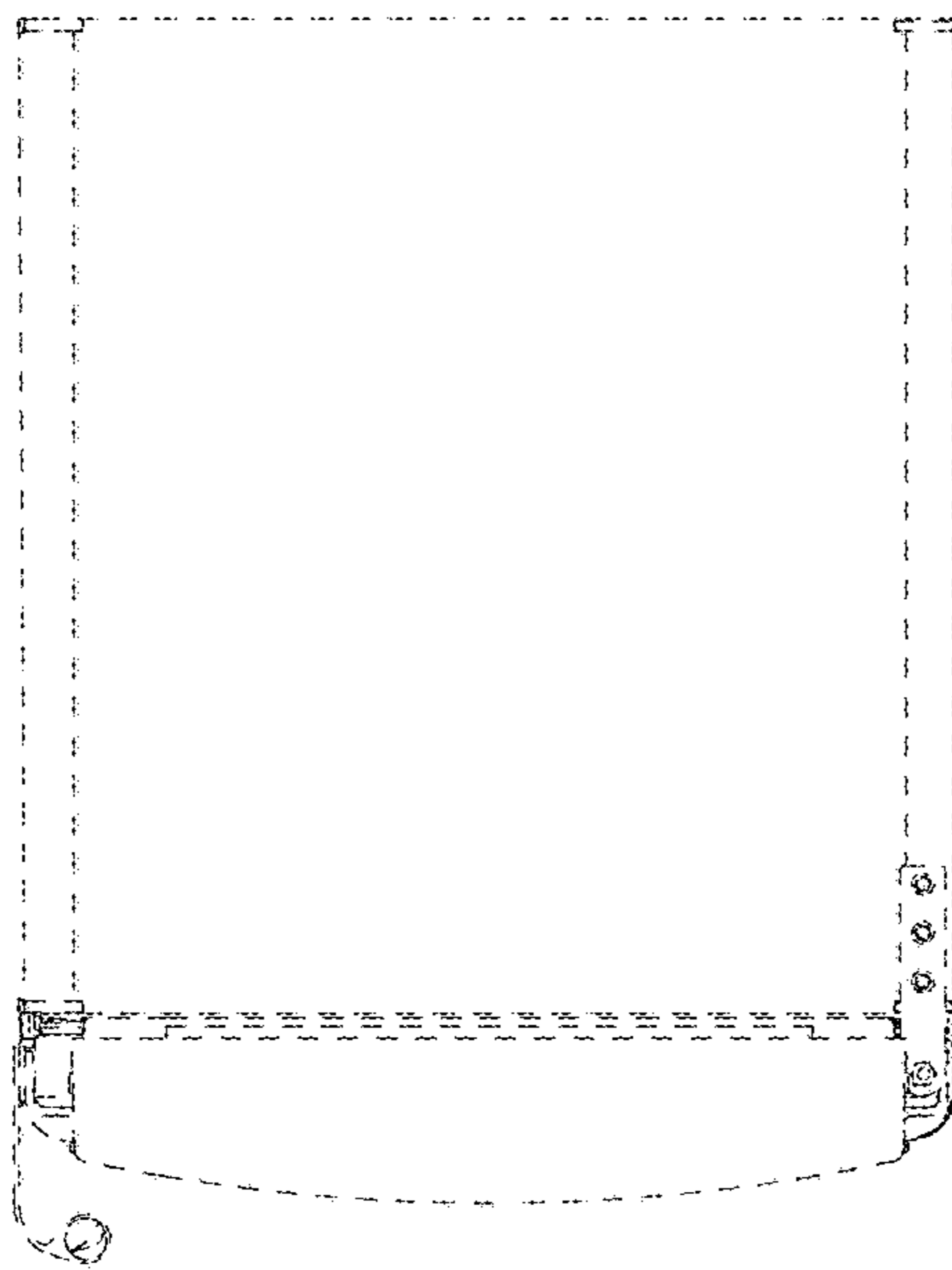

FIG. 13

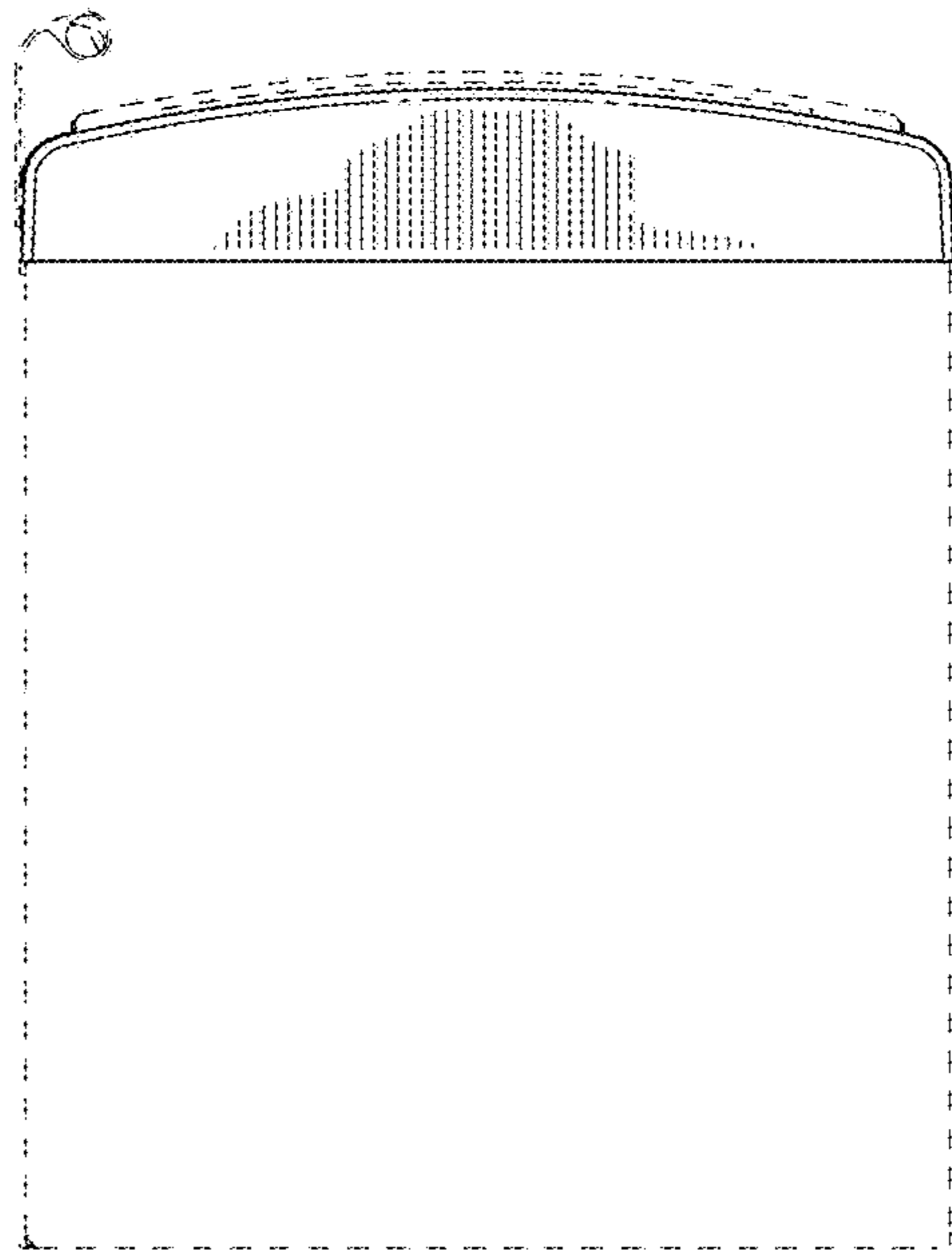

FIG. 14

UNITED STATES PATENT AND TRADEMARK OFFICE
CERTIFICATE OF CORRECTION

PATENT NO. : D852,235 S
APPLICATION NO. : 29/618832
DATED : June 25, 2019
INVENTOR(S) : Broen et al.

Page 1 of 1

It is certified that error appears in the above-identified patent and that said Letters Patent is hereby corrected as shown below:

On the Title Page

In the "Related U.S. Application Data" item (63), please replace:

"Continuation of application No. 29/598,961, filed on Mar. 30, 2017, now Pat. No. Des. 799,565, and a continuation of application No. 29/586,252, filed on Dec. 1, 2016, now Pat. No. Des. 799,566, which is a continuation of application No. 29/539,858, filed on Sep. 17, 2015, now Pat. No. Des. 787,565, and a continuation of application No. 29/539,858, filed on Sep. 17, 2015, now Pat. No. Des. 787,565."

With:

-- Continuation of application No. 29/598,961, filed on Mar. 30, 2017, now Pat. No. Des. 799,565, and a continuation of application No. 29/586,252, filed on Dec. 1, 2016, now Pat. No. Des. 799,565. Said application No. 29/598,961, filed on Mar. 30, 2017, is a continuation of application No. 29/539,858, filed on Sep. 17, 2015, now Pat. No. Des. 787,565. Said application No. 29/586,252, filed on Dec. 1, 2016, is a continuation of application No. 29/539,858, filed on Sep. 17, 2015, now Pat. No. Des. 787,565. --.

Signed and Sealed this
Third Day of September, 2019

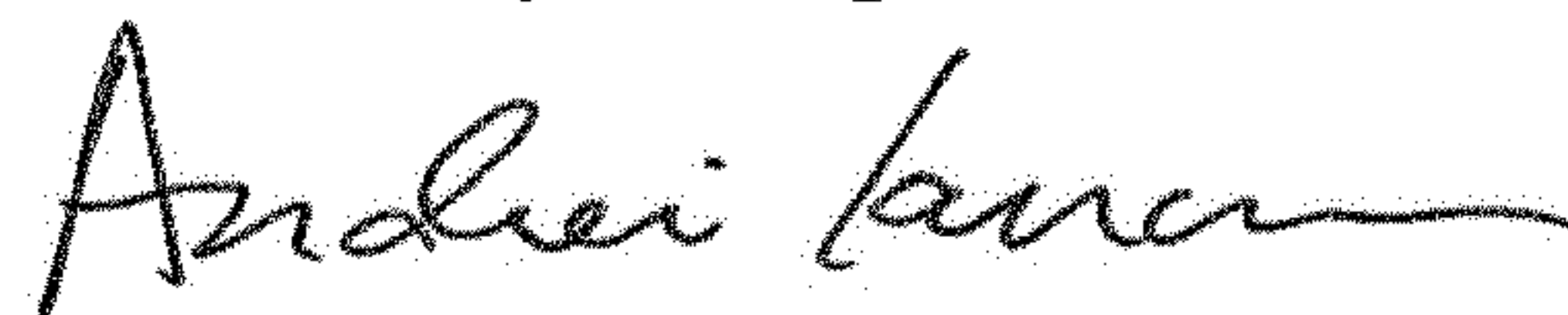

Andrei Iancu
Director of the United States Patent and Trademark Office