



US00D852187S

(12) **United States Design Patent**
Kevin

(10) **Patent No.:** **US D852,187 S**
(45) **Date of Patent:** **** Jun. 25, 2019**

- (54) **MOBILE PHONE CASE**
- (71) Applicant: **GRAY TECH INTERNATIONAL PRIVATE LIMITED**, Singapore (SG)
- (72) Inventor: **Ng Tze Yang Kevin**, Singapore (SG)
- (73) Assignee: **Gray Tech International Private Limited**, Singapore (SG)
- (**) Term: **15 Years**
- (21) Appl. No.: **35/503,279**
- (22) Filed: **Jan. 5, 2017**

- (80) **Hague Agreement Data**
- Int. Filing Date: **Oct. 20, 2016**
- Int. Reg. No.: **DM/094667**
- Int. Reg. Date: **Jan. 5, 2017**
- Int. Reg. Pub. Date: **Jul. 7, 2017**

- (51) **LOC (11) Cl.** **14-03**
- (52) **U.S. Cl.**
USPC **D14/250**
- (58) **Field of Classification Search**
USPC D14/250–253, 440, 203.3–203.7, 217, D14/496, 248, 238.1, 240, 447, 230, 247, D14/341, 345, 346, 439; D3/201, 218, D3/269, 301, 273, 303; D13/103, D13/107–108
CPC . A45C 2011/002; A45C 11/00; A45C 13/002; A45C 2011/003; H04M 1/0283; H04M 1/0202; H04M 1/185; H04B 1/3888
See application file for complete search history.

- (56) **References Cited**
- U.S. PATENT DOCUMENTS**
- D697,902 S * 1/2014 Fathollahi D14/250
- D746,805 S * 1/2016 Kim D14/250
- D748,613 S * 2/2016 Sasaki D14/250
- D767,551 S * 9/2016 Sasaki D14/250

- D794,006 S * 8/2017 Dong D14/250
- D800,711 S * 10/2017 Kim D14/250
- D803,206 S * 11/2017 Kim D14/250
- D811,379 S * 2/2018 Armstrong D14/250
- D813,857 S * 3/2018 Ackeret D14/250

OTHER PUBLICATIONS

TechSource, "\$1000 iPhone 6S Case—Advent, Published Dec. 9, 2015," <https://www.youtube.com/watch?v=APpuggmOHoY>.
Gray International, Machined Grade 5 Titanium, Published Sep. 9, 2015, "https://www.instagram.com/p/7apeGpyajg/?taken-by=gray_international".*

* cited by examiner

Primary Examiner — Holly E Thurman
(74) *Attorney, Agent, or Firm* — Procopio, Cory, Hargreaves & Savitch LLP

(57) **CLAIM**

The ornamental design for a mobile phone case, as shown and described.

DESCRIPTION

The patent or application file contains at least one drawing executed in color. Copies of this patent or patent application publication with color drawing(s) will be provided by the Office upon request and payment of the necessary fee.

- 1. Mobile phone case
- FIG. 1.1 is a perspective view according to the present invention;
- FIG. 1.2 is another perspective view thereof;
- FIG. 1.3 is a front view thereof;
- FIG. 1.4 is a back view thereof;
- FIG. 1.5 is top view thereof; and
- FIG. 1.6 is a side view thereof.

The word "Gray" and preceding symbol forming part of the claimed design is a registered trademark of Gray International.

1 Claim, 6 Drawing Sheets
(6 of 6 Drawing Sheet(s) Filed in Color)

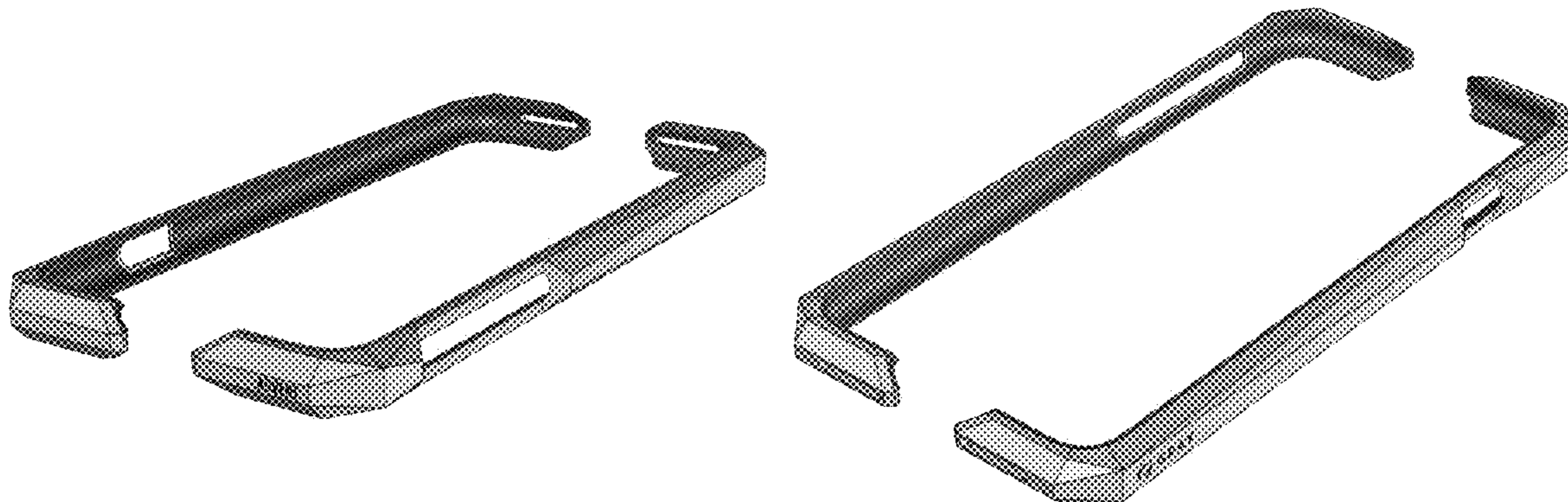

1.1

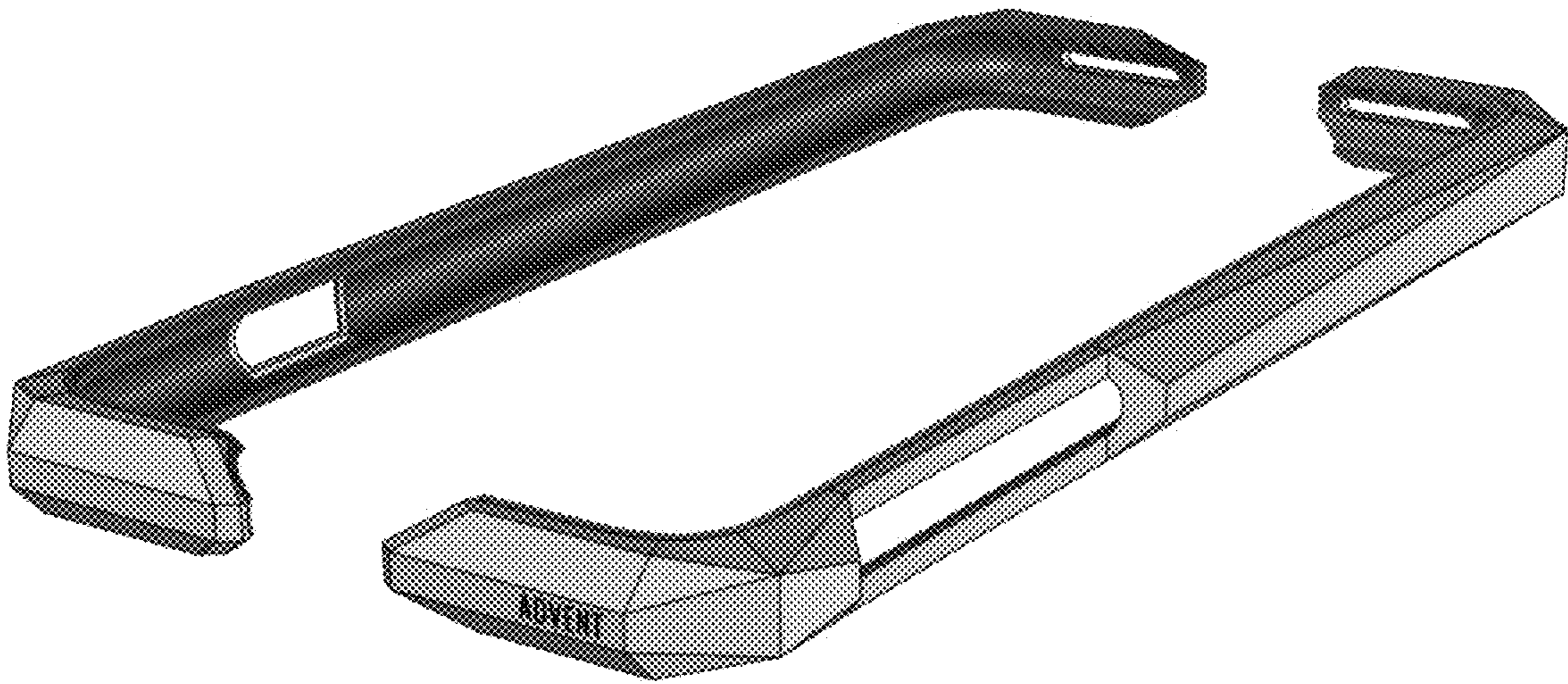

1.2



1.3

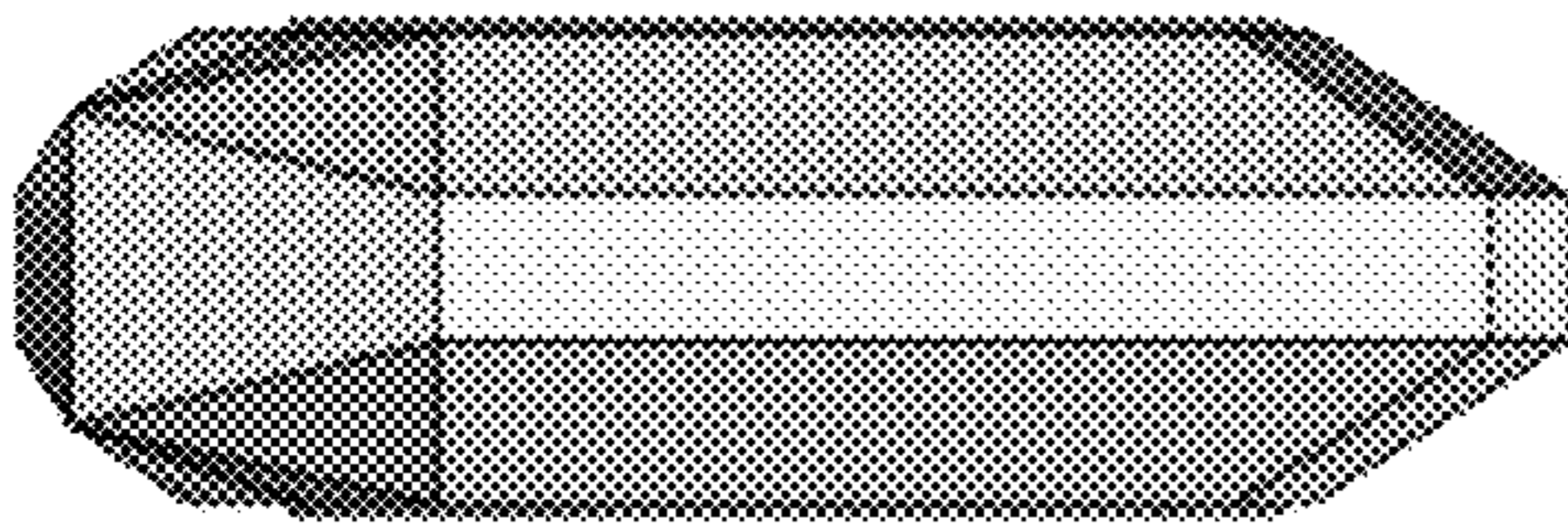

1.4

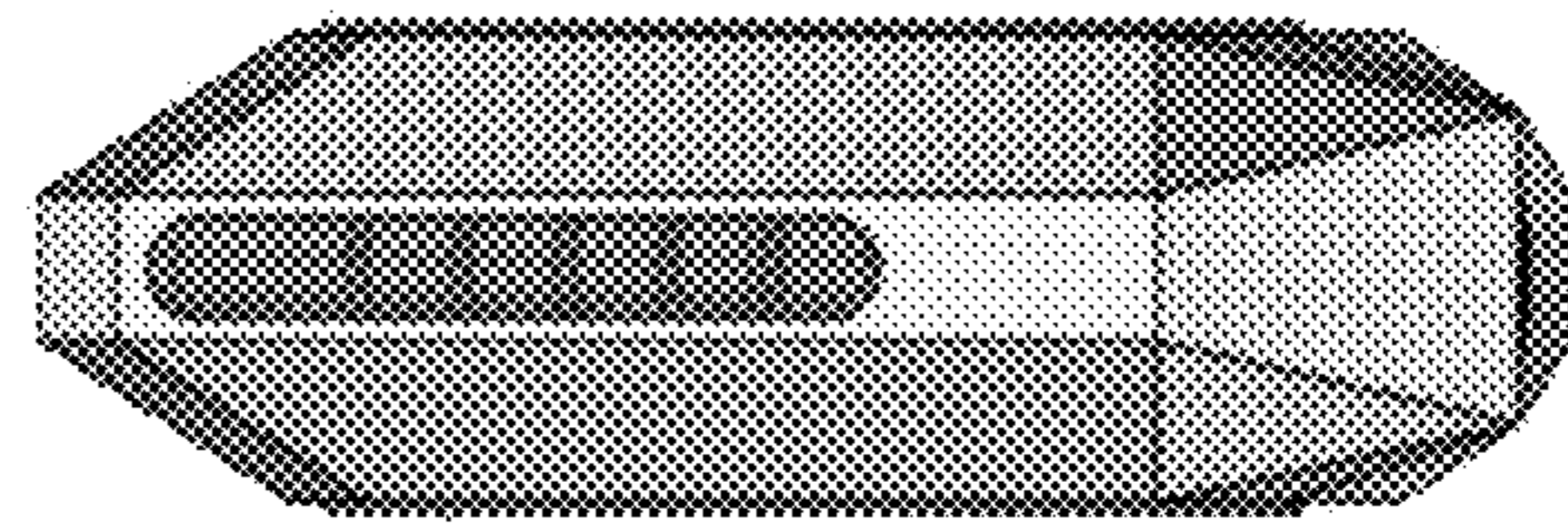
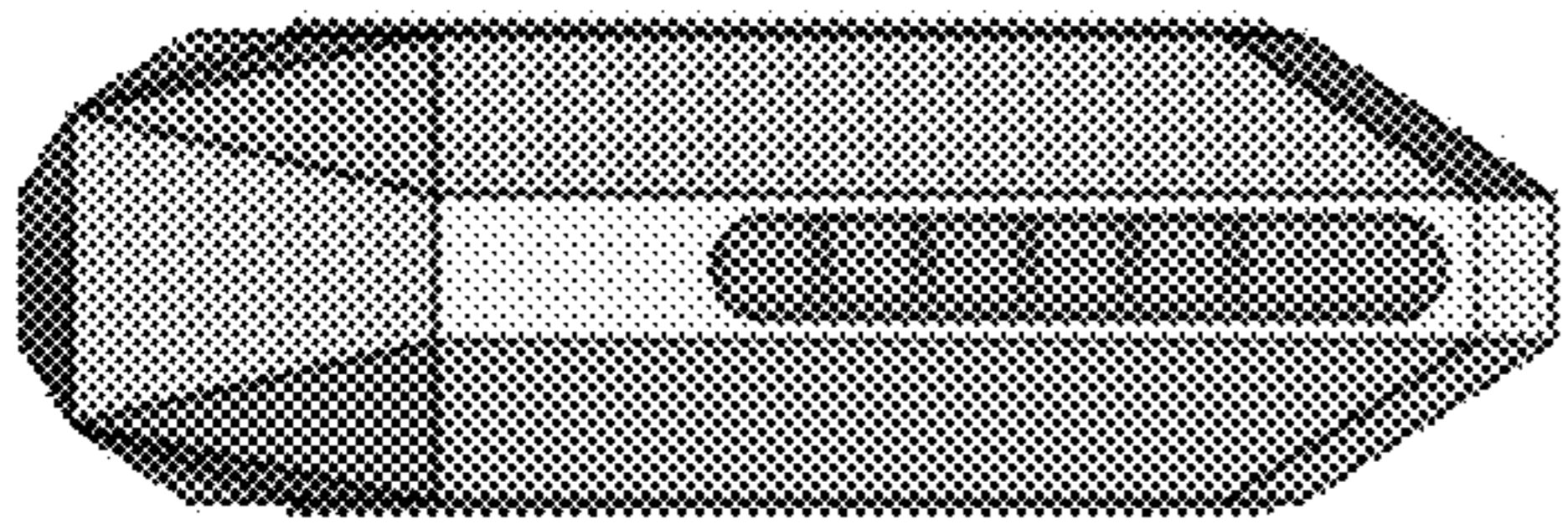

1.5

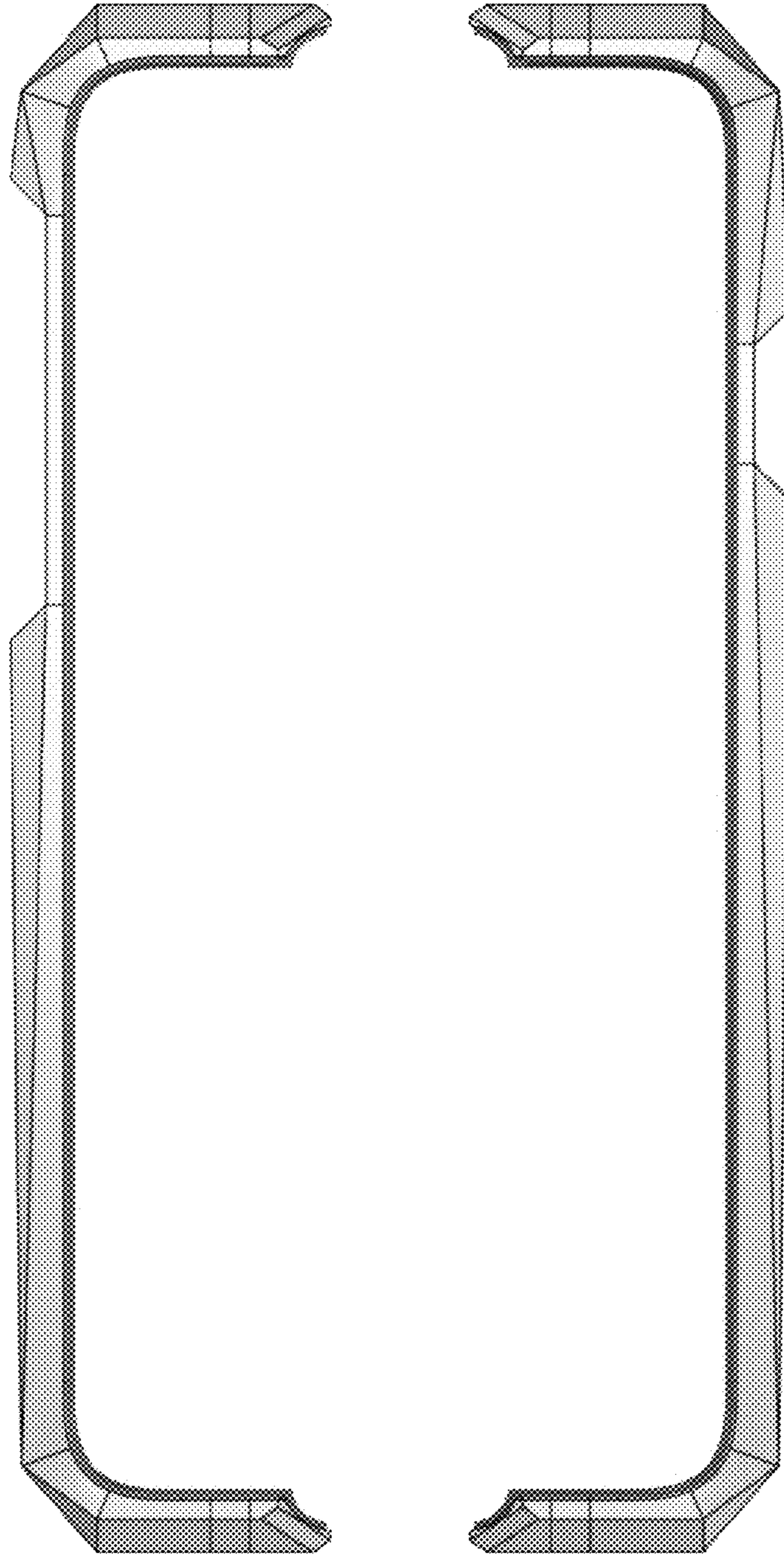

1.6

