



US00D852185S

(12) **United States Design Patent**
Yu

(10) **Patent No.:** **US D852,185 S**
(45) **Date of Patent:** **** Jun. 25, 2019**

(54) **CASE FOR ELECTRONIC DEVICE**

(71) Applicant: **Shenzhen IPAKY Electronic Technology Co., Ltd., Shenzhen (CN)**

(72) Inventor: **Genpei Yu, Shenzhen (CN)**

(**) Term: **15 Years**

(21) Appl. No.: **29/637,350**

(22) Filed: **Feb. 15, 2018**

(51) **LOC (11) Cl.** **14-03**

(52) **U.S. Cl.**
USPC **D14/250**

(58) **Field of Classification Search**
USPC D14/250
CPC A45C 2011/002
See application file for complete search history.

(56) **References Cited**

U.S. PATENT DOCUMENTS

D638,828 S *	5/2011	Melanson	D14/250
D656,495 S *	3/2012	Andre	D14/250
D669,458 S *	10/2012	Wilson	D14/250
D670,280 S *	11/2012	Rayner	D14/250
D677,251 S *	3/2013	Melanson	D14/250
D681,613 S *	5/2013	Magness	D14/238.1
D695,730 S *	12/2013	Wicks	D14/250
D703,652 S *	4/2014	Melanson	D14/250
D705,768 S *	5/2014	Melanson	D14/250
D706,253 S *	6/2014	Simmer	D14/250
D741,844 S *	10/2015	Rayner	D14/250
D765,636 S *	9/2016	Kanazawa	D14/250
D785,612 S *	5/2017	Kim	D14/248
D786,226 S *	5/2017	Kim	D14/248
D800,103 S *	10/2017	Andre	D14/250
D816,073 S *	4/2018	Kim	D14/250
D820,820 S *	6/2018	Ahn	D14/250
D829,200 S *	9/2018	Yun	D14/250

D830,357 S *	10/2018	Hori	D14/250
D832,831 S *	11/2018	Zhang	D14/250
D833,425 S *	11/2018	Ahn	D14/250
D841,636 S *	2/2019	Turk	B60R 11/02 D14/250
2017/0202345 A1 *	7/2017	Hall	A45F 5/021

OTHER PUBLICATIONS

AlCase iPhone 8 Plus Case, posted at amazon.com, posting date by Dec. 29, 2017, [online], [site visited Mar. 15, 2019]. Available from Internet, URL: <https://www.amazon.com/iPhone-AlCase-Anti-Scratches-Premium-Protective/dp/B0779V1SHY> (Year: 2017).*
Ansiwee iPhone 8 Plus Case, posted at amazon.com, posting date by Oct. 14, 2016, [online], [site visited Mar. 15, 2019]. Available from Internet, URL: <https://www.amazon.com/Ansiwee-Shockproof-Protective-Defender-Resistant/dp/B01K78K522> (Year: 2016).*

(Continued)

Primary Examiner — George D. Kirschbaum

Assistant Examiner — Maria J Edwards

(74) *Attorney, Agent, or Firm* — Novoclaims Patent Services LLC; Mei Lin Wong

(57) **CLAIM**

The ornamental design of a case for electronic device, as shown and described.

DESCRIPTION

FIG. 1 is a front perspective view of a case for electronic device showing my new design;
FIG. 2 is a rear perspective view thereof;
FIG. 3 is a front view thereof;
FIG. 4 is a rear view thereof;
FIG. 5 is a left side view thereof;
FIG. 6 is a right side view thereof;
FIG. 7 is a top view thereof; and,
FIG. 8 is a bottom view thereof.

1 Claim, 8 Drawing Sheets

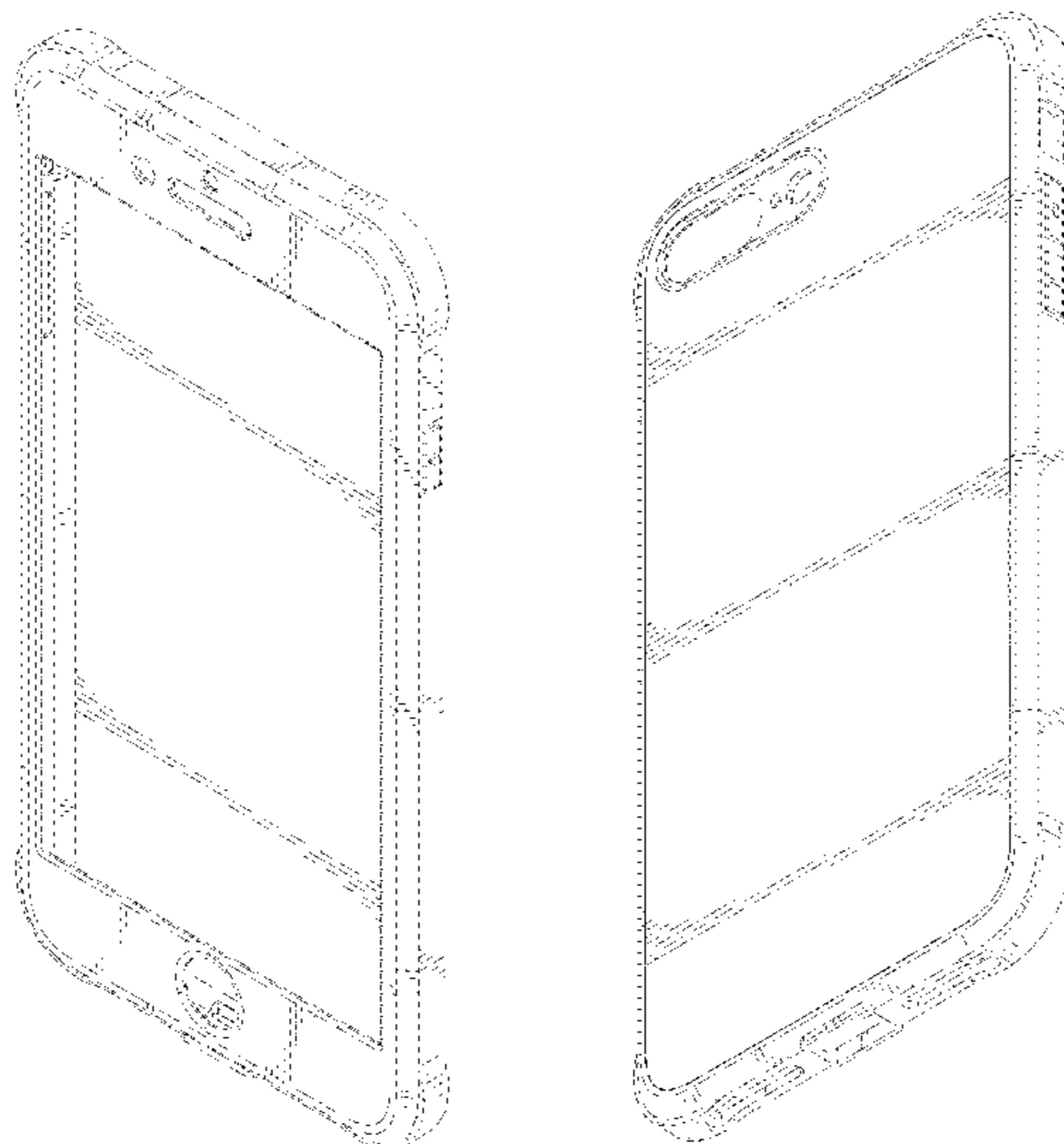

(56)

References Cited

OTHER PUBLICATIONS

Matone iPhone 7 Plus Case, posted at amazon.com, posting date by Jan. 16, 2017, [online], [site visited Mar. 15, 2019]. Available from Internet, URL: <https://www.amazon.com/dp/B01L1F1OV6/> (Year: 2017).*

Moko iPhone 8 Plus Case, posted at amazon.com, posting date by May 24, 2017, [online], [site visited Mar. 15, 2019]. Available from Internet, URL: <https://www.amazon.com/iPhone-Plus-Case-Absorption-Protective/dp/B01N91ZQFF> (Year: 2017).*

Speira iPhone 8 Plus and iPhone 7 Plus Transparent Case, posted at amazon.com, posting date by Aug. 24, 2017, [online], [site visited Mar. 15, 2019]. Available from Internet, URL: <https://www.amazon.com/Speira-Transparent-Reinforced-Corners-Anti-Discoloration/dp/B0758K6MSX> (Year: 2017).*

* cited by examiner

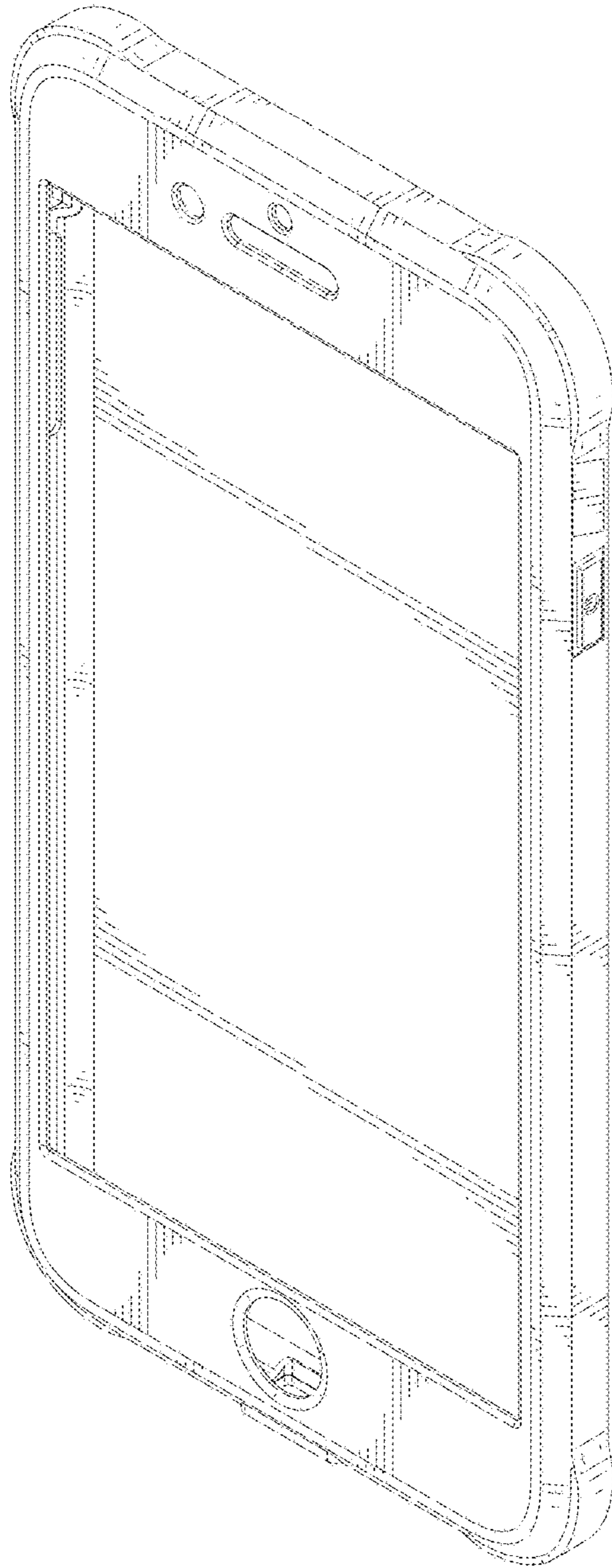

FIG. 1

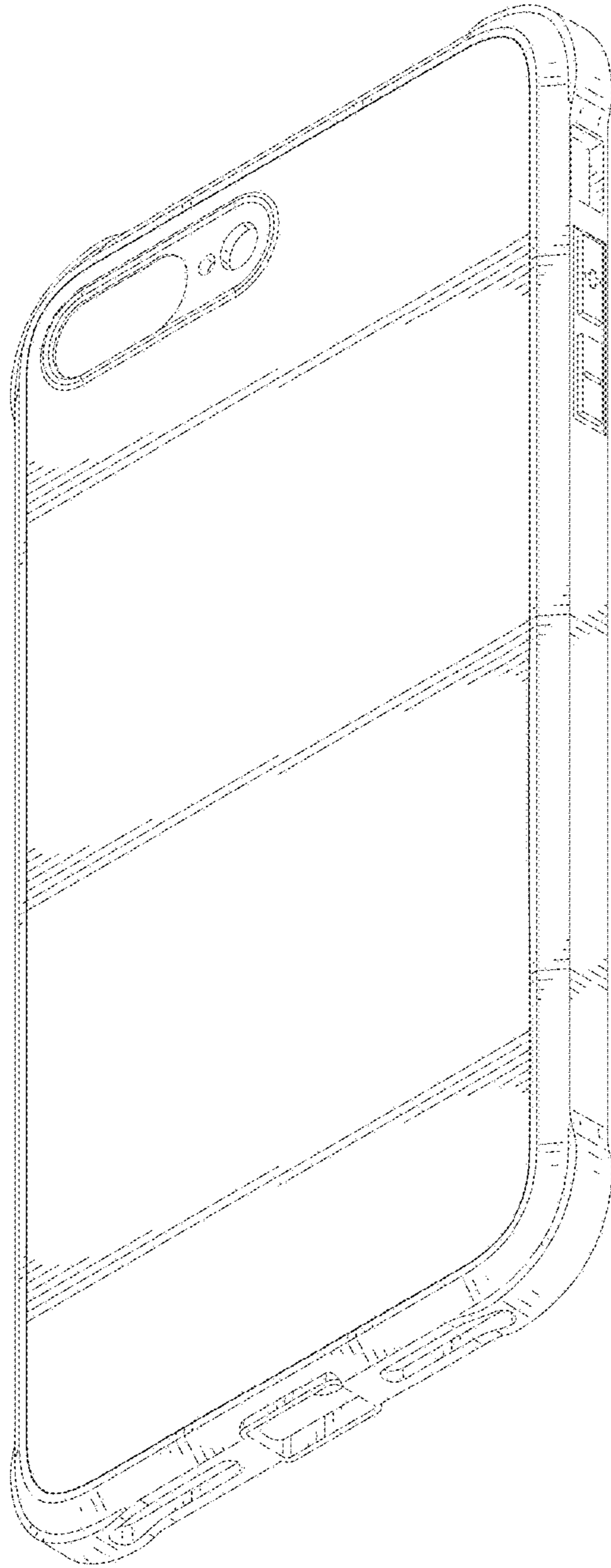

FIG.2

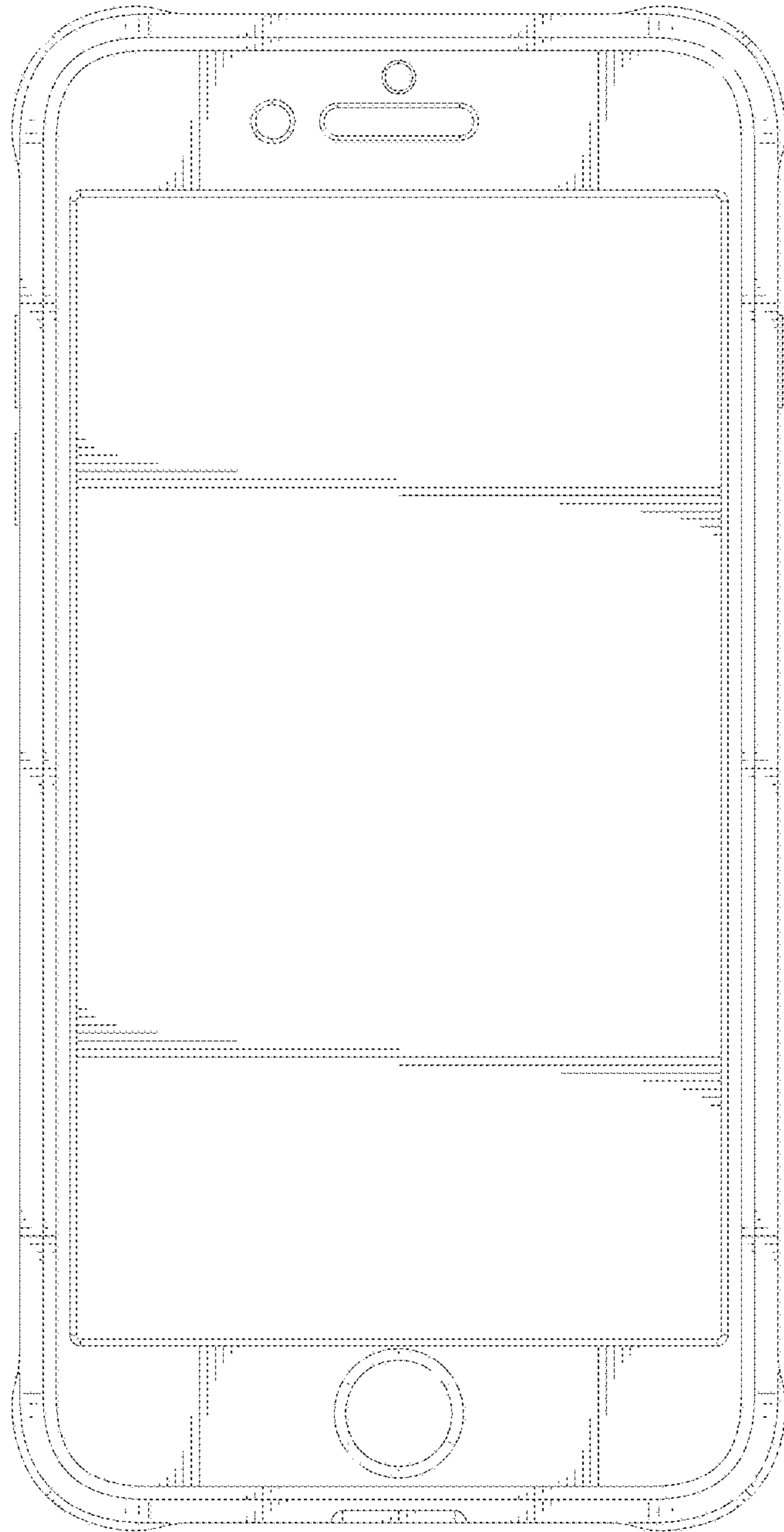

FIG.3

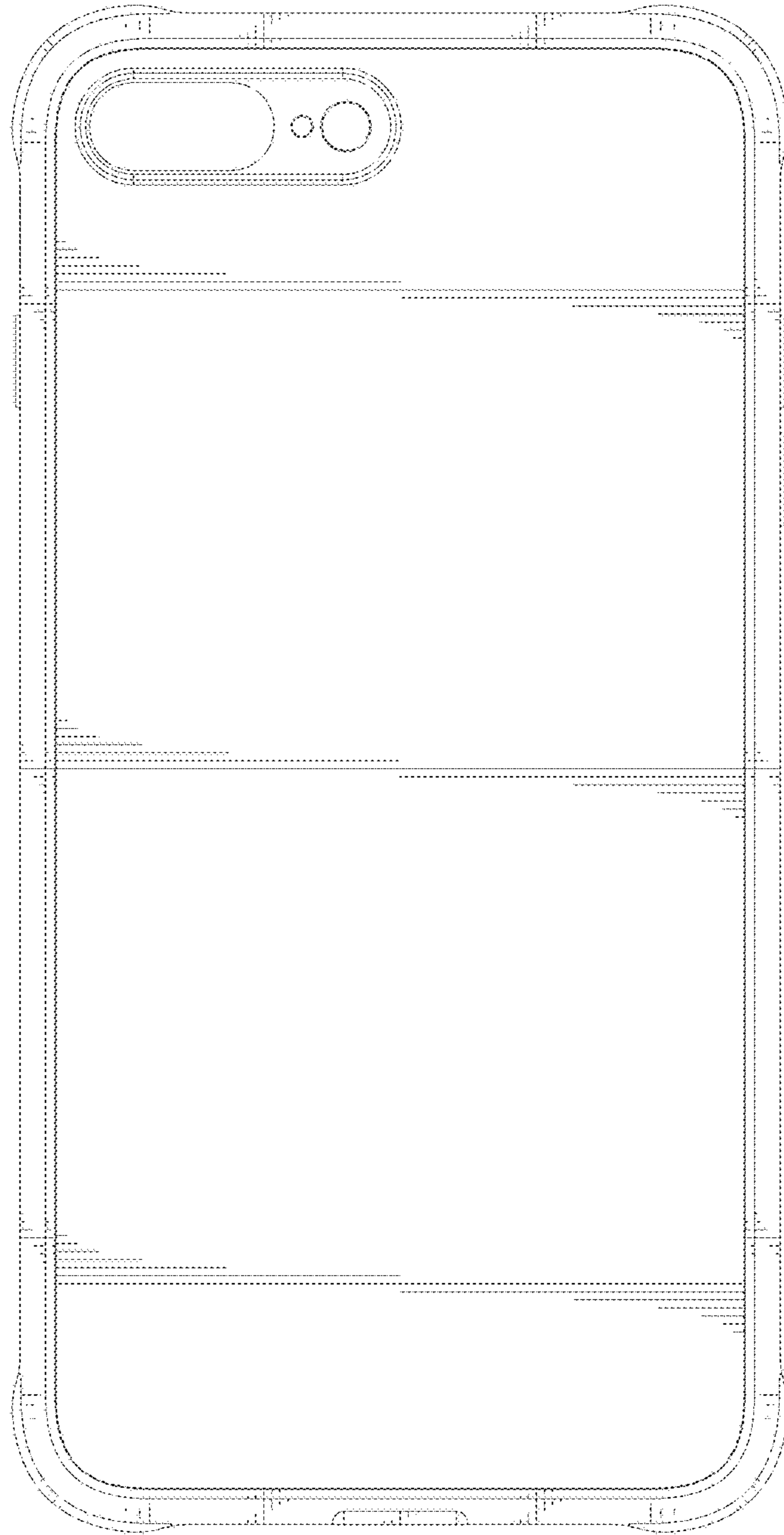

FIG.4



FIG.5

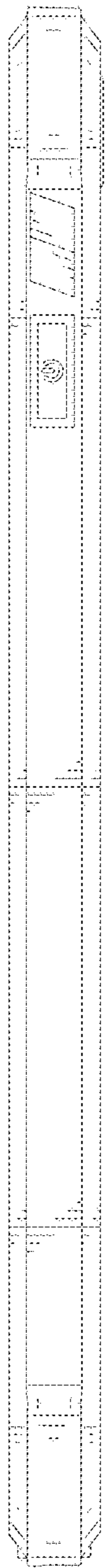

FIG.6

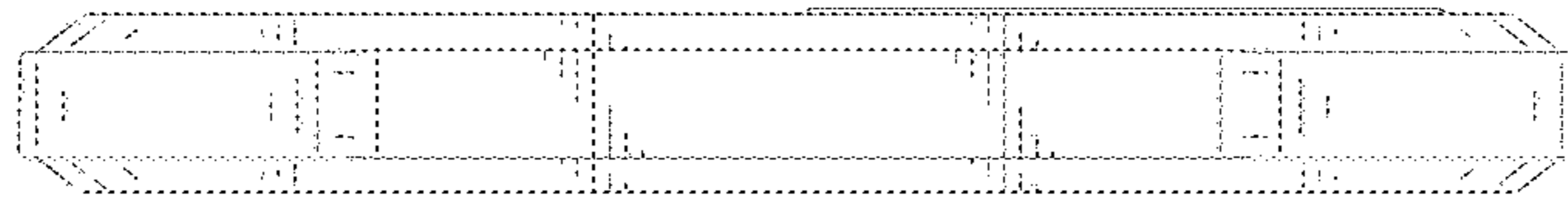

FIG.7

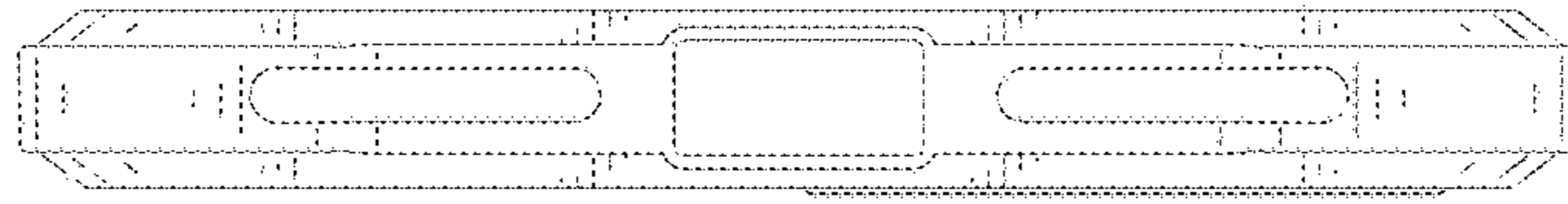

FIG.8