



US00D852051S

(12) **United States Design Patent**
Jack et al.

(10) **Patent No.:** **US D852,051 S**
(45) **Date of Patent:** **** Jun. 25, 2019**

(54) **BOTTLE**
(71) Applicant: **IntraPac International LLC**,
Mooresville, NC (US)
(72) Inventors: **Robert C. Jack**, Arlington Heights, IL
(US); **Megan E. Keilman**, Shabbona,
IL (US)
(73) Assignee: **IntraPac International LLC**,
Mooresville, SC (US)

D243,659 S 3/1977 Plummer
D254,651 S * 4/1980 Shortino D9/574
D309,714 S * 8/1990 Biesecker D9/542
D310,964 S 10/1990 Weckman
D321,131 S 10/1991 Wiseman et al.
D340,864 S 11/1993 De Rothschild et al.
D352,657 S 11/1994 Gonda et al.
D367,010 S 2/1996 Moore et al.
D375,051 S 10/1996 Lathrop et al.
(Continued)

(**) Term: **15 Years**
(21) Appl. No.: **29/659,196**
(22) Filed: **Aug. 7, 2018**

Related U.S. Application Data

(63) Continuation of application No. 29/592,120, filed on
Jan. 26, 2017.
(51) **LOC (11) Cl.** **09-01**
(52) **U.S. Cl.**
USPC **D9/563**
(58) **Field of Classification Search**
USPC D9/434-435, 439, 447, 449, 450, 452,
D9/454, 516, 520, 522-524, 528-531,
D9/541-544, 549-551, 558-560, 563,
D9/565-566, 571-575, 682, 686, 687,
D9/693-694, 715, 719; D7/300, 300.1,
D7/316, 317, 598; D23/202, 211, 225
CPC ... B65D 1/00; B65D 1/02; B65D 1/12; B65D
1/18; B65D 1/20; B65D 1/0223; B65D
23/00; B65D 21/0237; B65D 2501/0009;
B65D 2501/0081
See application file for complete search history.

(56) **References Cited**

U.S. PATENT DOCUMENTS

D94,498 S * 2/1935 Leach D9/574
D185,432 S 6/1959 Goldstein

OTHER PUBLICATIONS

Unpublished pending U.S. Appl. No. 29/592,119, filed Jan. 26, 2017
which is not being furnished herewith, pursuant to the Commis-
sioner's Notice dated Sep. 21, 2004.

(Continued)

Primary Examiner — Susan Bennett Hattan
Assistant Examiner — Omeed Agilee

(74) *Attorney, Agent, or Firm* — Neal, Gerber &
Eisenberg LLP; Thomas E. Williams

(57) **CLAIM**

The ornamental design for a bottle, as shown and described.

DESCRIPTION

FIG. 1 is a front, right, and top perspective view of a bottle,
showing our new design;
FIG. 2 is a front, right, and bottom perspective view thereof;
FIG. 3 is a front elevation view thereof;
FIG. 4 is a rear elevation view thereof;
FIG. 5 is a left side elevation view thereof;
FIG. 6 is a right side elevation view thereof;
FIG. 7 is a top plan view thereof; and,
FIG. 8 is a bottom plan view thereof.
The broken lines are included for illustrating portions of the
bottle that form no part of the claimed design.

1 Claim, 6 Drawing Sheets

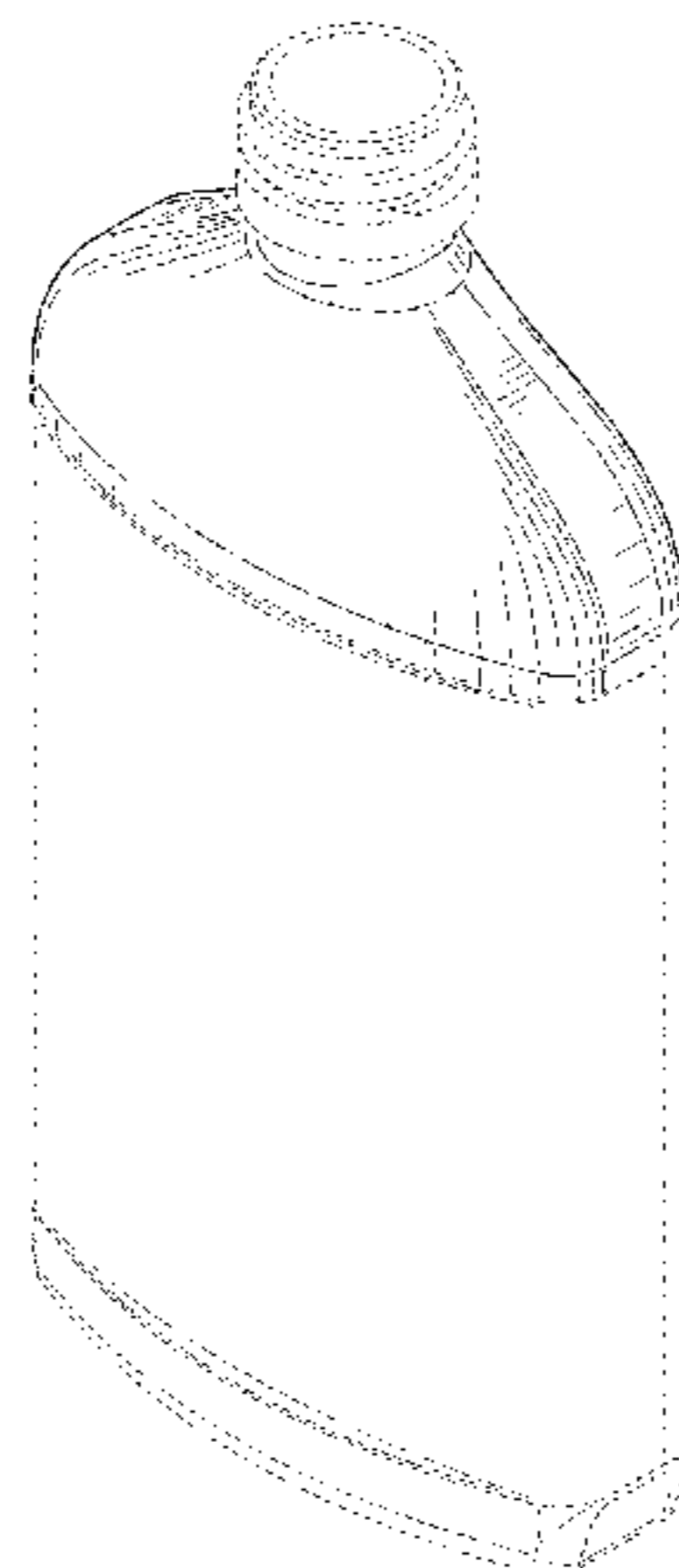

(56)

References Cited

U.S. PATENT DOCUMENTS

D382,808 S * 8/1997 Fenton D9/522
 D392,895 S * 3/1998 Kuzma D9/558
 D396,191 S * 7/1998 Kuzma D9/574
 D407,210 S 3/1999 Lauth, III
 D429,629 S * 8/2000 Kuzma D9/574
 D495,609 S 9/2004 Wurster
 6,997,337 B1 * 2/2006 Wurster B65D 1/0223
 215/365
 D524,536 S 7/2006 Warner
 D529,814 S 10/2006 Winkler et al.
 D535,887 S * 1/2007 Haubert, III D9/558
 D536,619 S * 2/2007 Heisner D9/541
 D539,150 S 3/2007 Leoncavallo et al.
 D554,520 S 11/2007 Kunesh et al.
 D555,500 S * 11/2007 Johnston D9/563
 D562,138 S 2/2008 Warner
 D570,218 S 6/2008 Crawford et al.
 D585,755 S 2/2009 Dodge et al.
 D587,590 S 3/2009 Crawford et al.
 D615,415 S 5/2010 Holmes et al.
 D632,581 S * 2/2011 Kuzma D9/558
 D641,247 S 7/2011 Kuzma et al.
 D642,065 S 7/2011 Araujo et al.
 D645,358 S 9/2011 de Monclin
 D646,979 S * 10/2011 Shaw D9/542
 D653,555 S * 2/2012 Kelly D9/563
 D653,847 S 2/2012 Seals
 D655,172 S 3/2012 Brooks et al.
 D668,962 S 10/2012 Middleton
 D672,248 S * 12/2012 Nukuto D9/542
 D696,132 S 12/2013 Krunas
 D709,380 S 7/2014 Letamendi
 D709,771 S * 7/2014 Letamendi D9/545
 D718,044 S 11/2014 Vargo
 D729,631 S * 5/2015 Kuzma D9/542
 D731,318 S 6/2015 Monaghan et al.
 D736,517 S 8/2015 Lee
 D740,677 S 10/2015 Kuzma et al.

D742,749 S 11/2015 Murray
 D746,261 S 12/2015 Silvera
 D760,089 S * 6/2016 Collier D9/516
 D761,657 S * 7/2016 Gotur D9/542
 D764,928 S 8/2016 Staab
 D775,530 S 1/2017 Gayner et al.
 D799,330 S 10/2017 Burgbacher et al.
 D807,757 S * 1/2018 Feletto D9/558
 D816,983 S 5/2018 LiCalsi
 D825,340 S * 8/2018 Halloran D9/516
 D825,914 S 8/2018 Dent
 D827,441 S 9/2018 Jack et al.
 D827,445 S 9/2018 Jack et al.
 D830,186 S * 10/2018 Thompson D9/558
 2016/0001924 A1 1/2016 Liu

OTHER PUBLICATIONS

Unpublished pending U.S. Appl. No. 29/592,120, filed Jan. 26, 2017 which is not being furnished herewith, pursuant to the Commissioner's Notice dated Sep. 21, 2004.
 Unpublished pending U.S. Appl. No. 29/658,781, filed Aug. 2, 2018 which is not being furnished herewith, pursuant to the Commissioner's Notice dated Sep. 21, 2004.
 Unpublished pending U.S. Appl. No. 29/658,783, filed Aug. 2, 2018 which is not being furnished herewith, pursuant to the Commissioner's Notice dated Sep. 21, 2004.
 Unpublished pending U.S. Appl. No. 29/659,341, filed Aug. 8, 2018 which is not being furnished herewith, pursuant to the Commissioner's Notice dated Sep. 21, 2004.
 Liquor. Online, published date unknown. Retrieved on Oct. 31, 2017 by Examiner in U.S. Appl. No. 29/592,119 from URL: <http://www.intrapacinternational.com/products/bottles/liquor/> (1 page). English Pewter Company 6oz Plain Satin Band Hip Flask. Online, published date unknown. Retrieved on Nov. 15, 2018 from Url: <https://www.johnlewis.com/english-pewter-company-6oz-plain-satin-band-hip-flask/p2603333>.

* cited by examiner

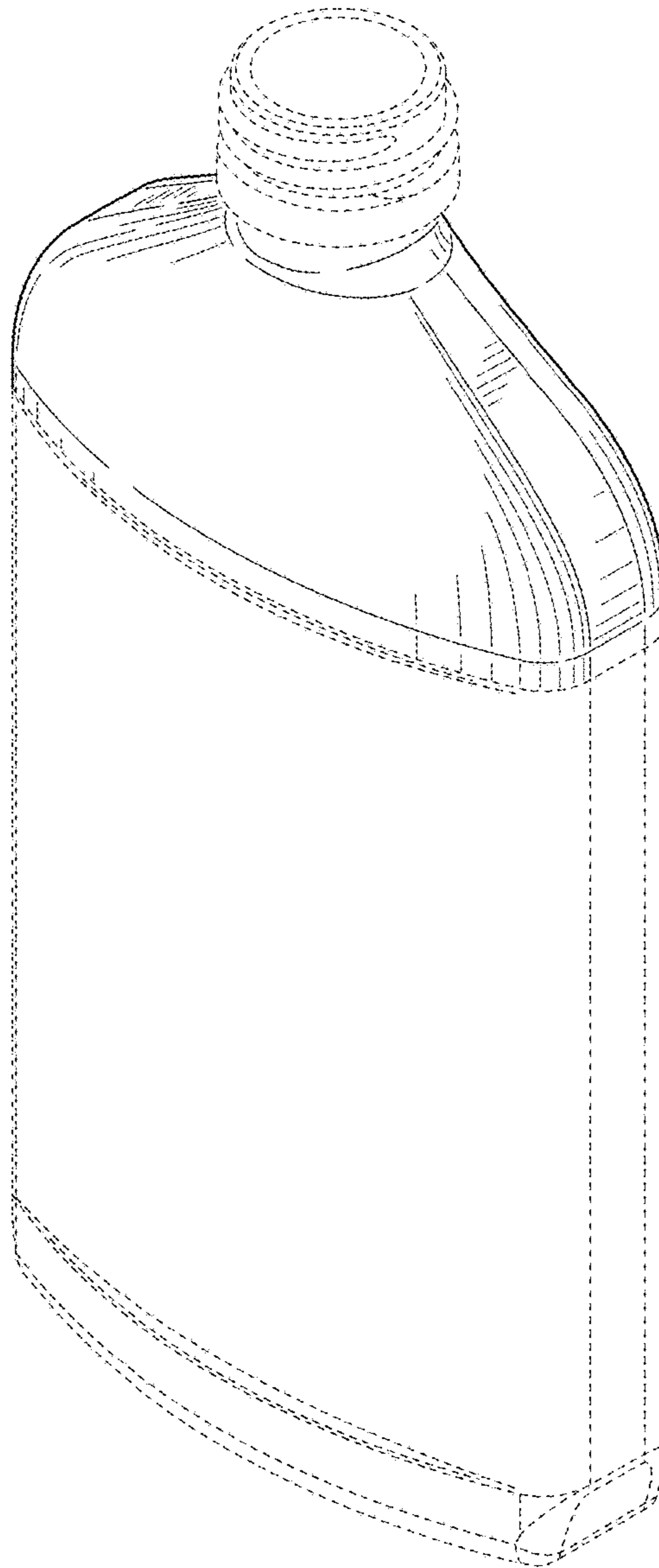

FIG. 1

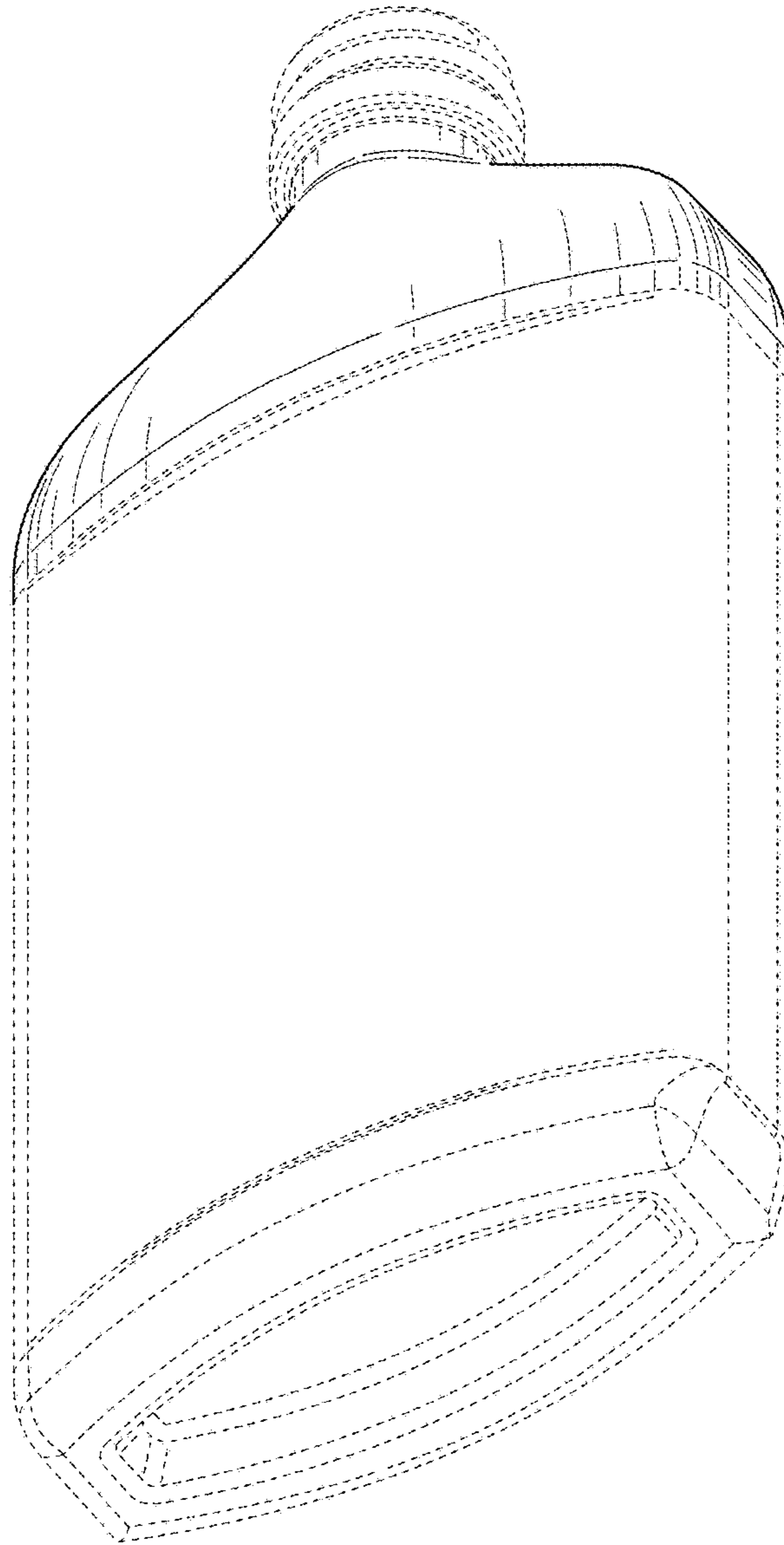

FIG. 2

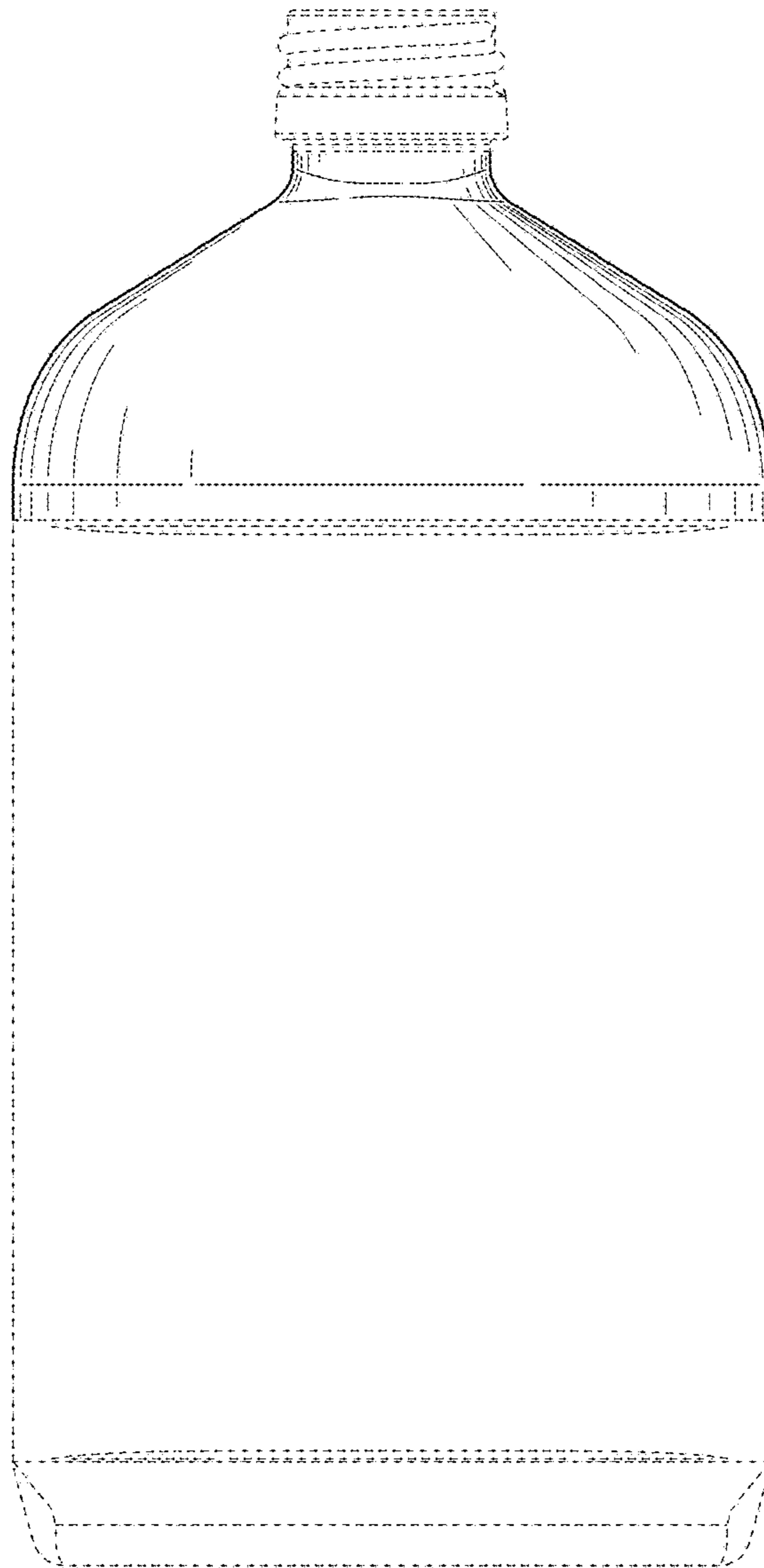

FIG. 3

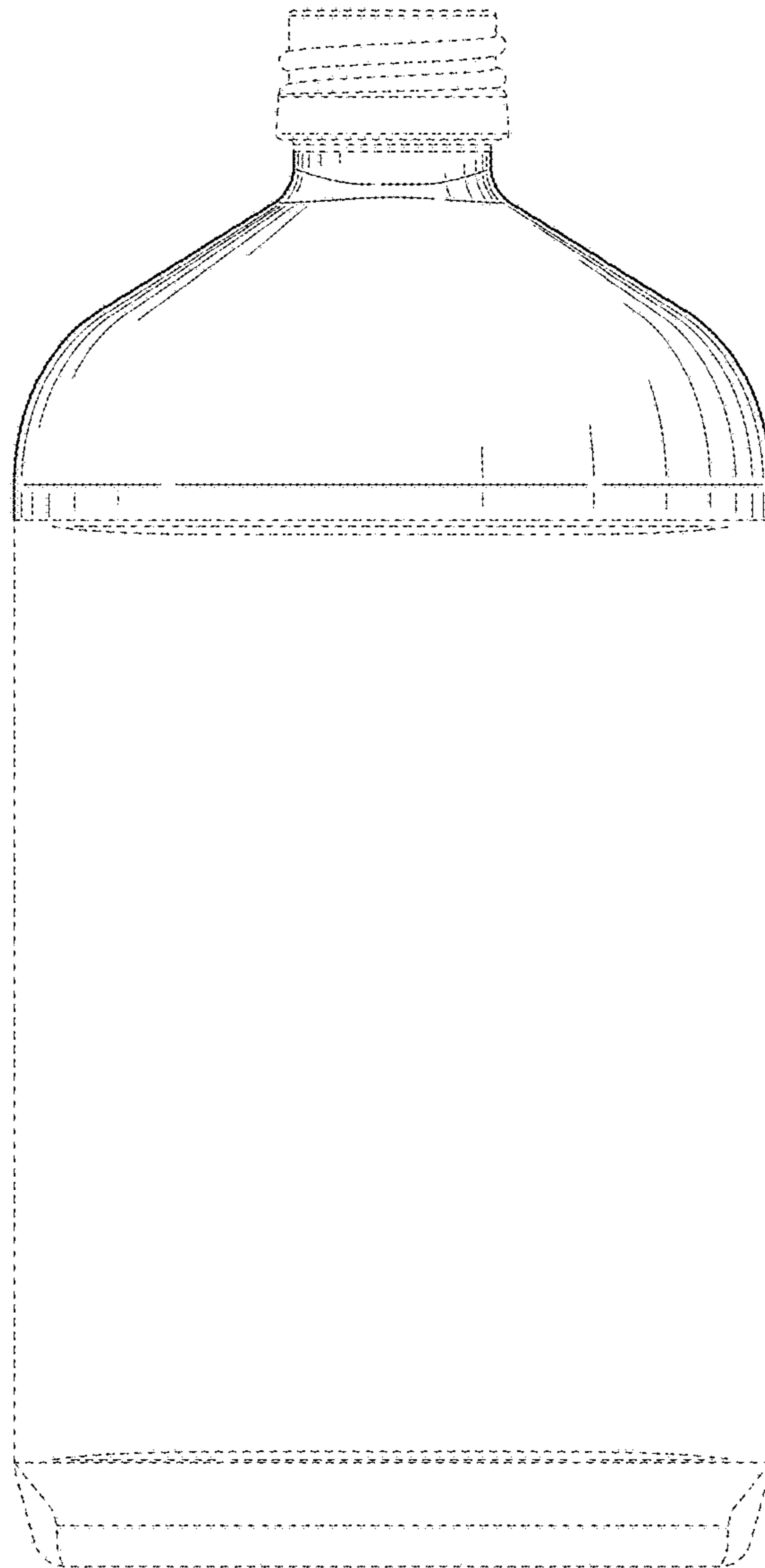

FIG. 4

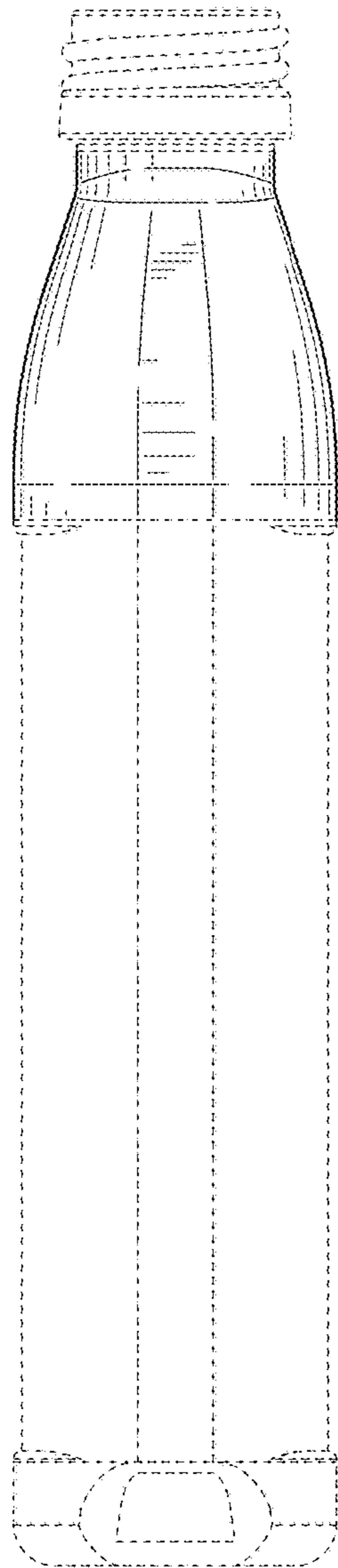

FIG. 5

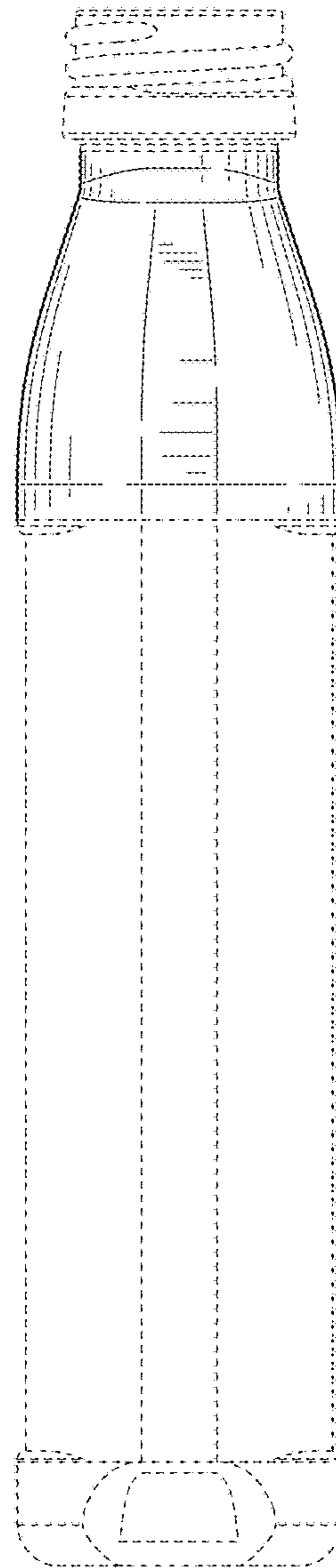

FIG. 6

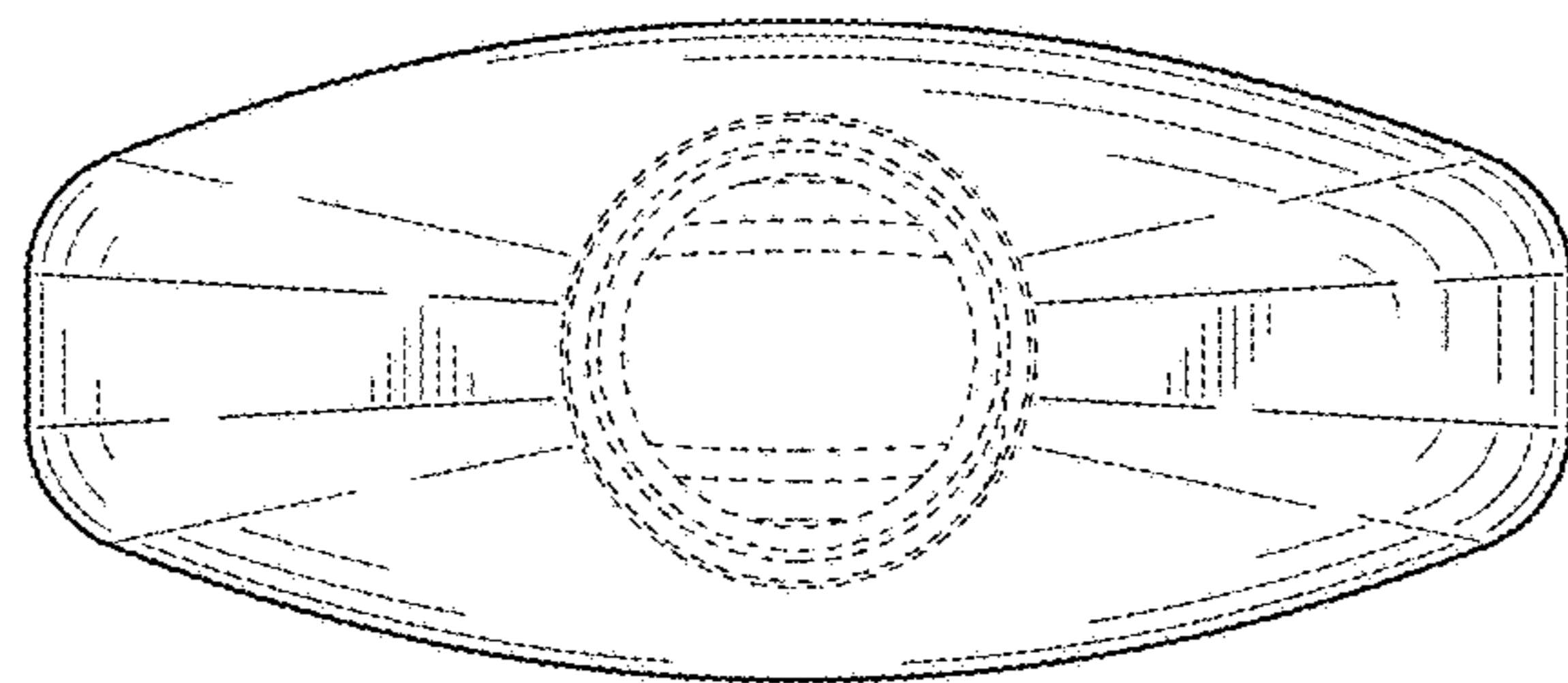

FIG. 7

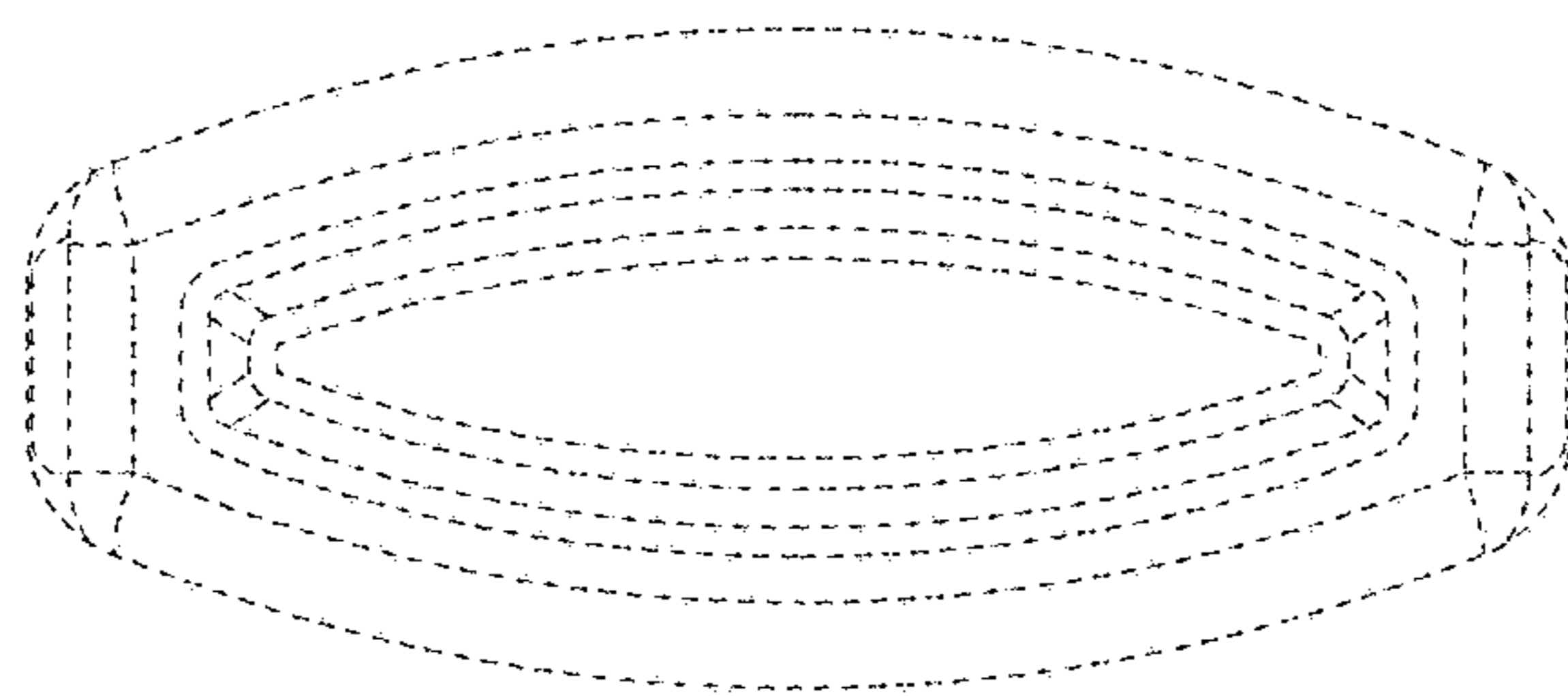

FIG. 8