



US00D852003S

(12) **United States Design Patent**
Rüsch

(10) **Patent No.:** **US D852,003 S**
(45) **Date of Patent:** **** Jun. 25, 2019**

(54) **KNIFE BLOCK**
(71) Applicant: **Zwilling J.A. Henckels AG**, Solingen (DE)
(72) Inventor: **Andreas Rüsch**, Velbert (DE)
(73) Assignee: **Zwilling J.A. Henckels AG** (DE)
(**) Term: **15 Years**
(21) Appl. No.: **29/623,687**
(22) Filed: **Oct. 26, 2017**

4,537,315 A 8/1985 Griffin
D280,587 S 9/1985 Carlson
4,561,548 A 12/1985 Call
4,601,400 A 7/1986 Buchanan et al.
4,693,439 A * 9/1987 Hahn G09F 23/06
248/300
D300,497 S * 4/1989 Goebel D7/637
4,866,845 A 9/1989 McEvily
4,970,006 A 11/1990 Martinez
5,245,756 A 9/1993 Howell
5,361,915 A 11/1994 Cohen et al.
D358,173 S 5/1995 Stoudt
D380,940 S 7/1997 Conner
D382,773 S 8/1997 Cohen et al.
D382,774 S 8/1997 Cohen et al.

(Continued)

(30) **Foreign Application Priority Data**

May 17, 2017 (EM) 004005072-0001

(51) **LOC (11) Cl.** **07-07**

(52) **U.S. Cl.**
USPC **D7/637**

(58) **Field of Classification Search**
USPC D7/637-638; 30/298.4, 296.1; 206/372,
206/373, 553; 211/70.7; 248/37.3, 111
CPC A47B 88/20; A47F 7/00; A47G 21/00;
A47G 21/14; B26B 3/00
See application file for complete search history.

(56) **References Cited**

U.S. PATENT DOCUMENTS

D104,380 S 5/1937 Poglein
2,430,700 A 11/1947 Berman
2,495,866 A 1/1950 Perry et al.
D230,554 S 3/1974 McNair
D240,496 S 7/1976 Schultz et al.
3,980,608 A 9/1976 Faltsack
D247,735 S 4/1978 Gangelhoff et al.
D247,736 S 4/1978 Gangelhoff
D267,142 S 12/1982 Pollard
D271,171 S 11/1983 Kinkade
4,423,552 A 1/1984 Bourgein et al.
4,509,651 A 4/1985 Prindle

FOREIGN PATENT DOCUMENTS

CN 105212803 A 1/2016
KR 20110006563 U 6/2011

Primary Examiner — Derrick E Holland

Assistant Examiner — Janice Patyk

(74) *Attorney, Agent, or Firm* — Gregory L. Mayback

(57) **CLAIM**

The ornamental design for a knife block, as shown and described.

DESCRIPTION

FIG. 1 is a perspective view of a knife block showing my new design;

FIG. 2 is a front elevational view thereof;

FIG. 3 is a rear elevational view thereof;

FIG. 4 is a left side elevational view thereof;

FIG. 5 is a right side elevational view thereof;

FIG. 6 is a top plan view thereof; and,

FIG. 7 is a bottom plan view thereof.

The broken lines in the figures illustrate the portions of the design that form no part of the claimed design.

1 Claim, 6 Drawing Sheets

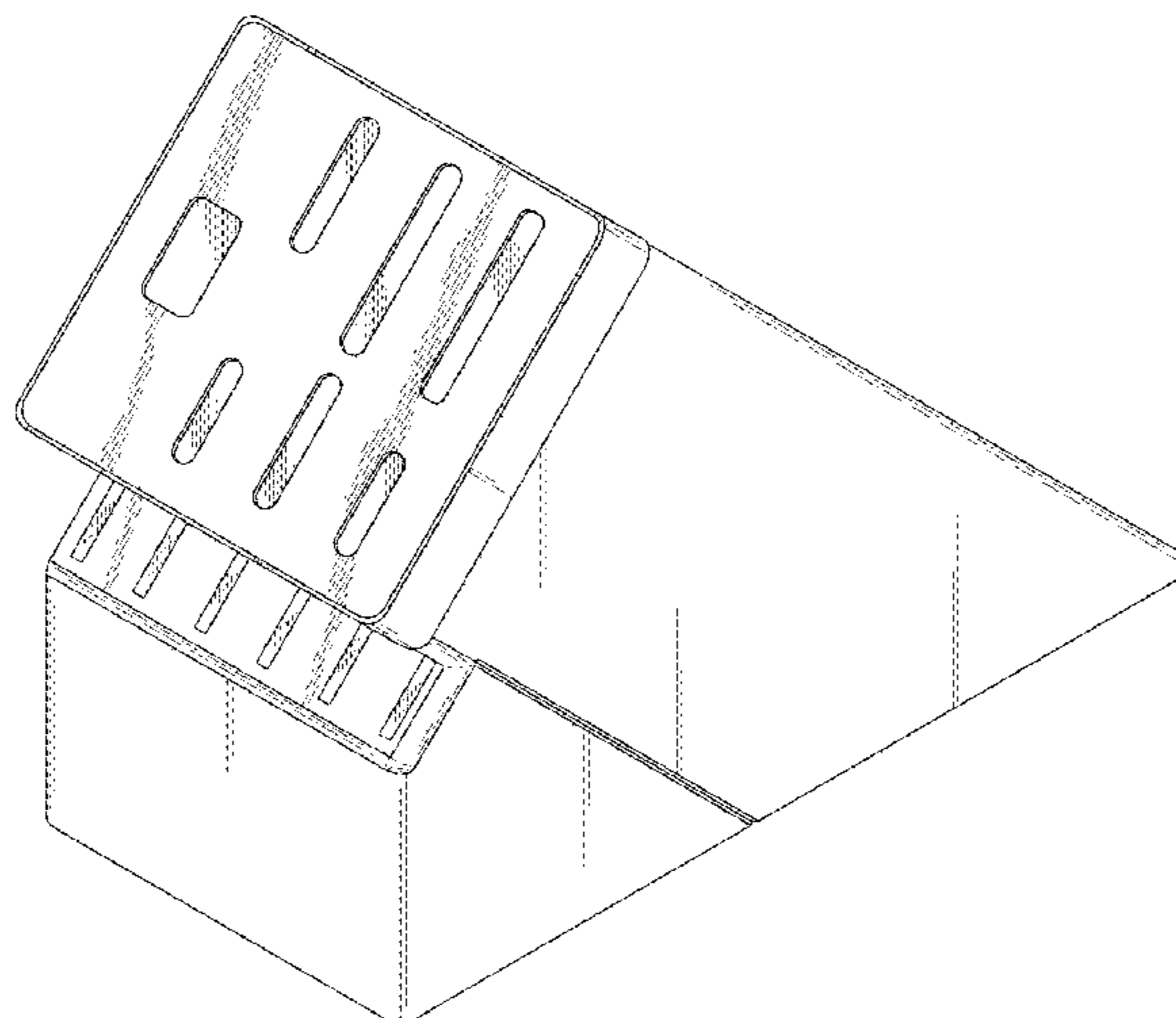

(56)

References Cited

U.S. PATENT DOCUMENTS

D382,775 S * 8/1997 Skerker D7/638
 5,655,672 A 8/1997 Stuchlik, III
 D396,386 S 7/1998 Conner
 5,775,518 A 7/1998 Connor
 5,850,784 A 12/1998 Conner
 D421,879 S 3/2000 Miller et al.
 D422,850 S 4/2000 Ancona et al.
 6,058,609 A 5/2000 Yen
 D426,139 S 6/2000 Christoffel et al.
 6,079,108 A 6/2000 Lin
 6,082,559 A 7/2000 Levsen
 D434,615 S 12/2000 Chien
 D440,124 S 4/2001 Weng
 6,371,312 B1 4/2002 Tsuchida
 6,394,627 B1 5/2002 Lo
 D471,072 S 3/2003 Gordner
 D478,787 S 8/2003 Logiudice et al.
 D483,624 S 12/2003 Bradshaw
 7,322,113 B2 1/2008 Tetreault et al.

D571,619 S * 6/2008 Abo D7/637
 D572,982 S 7/2008 De Bretton Gordon
 7,631,772 B2 12/2009 Lafleur
 7,637,803 B2 12/2009 Welch
 D657,635 S 4/2012 De Bretton Gordon
 D688,922 S * 9/2013 Batliner D7/637
 D764,875 S 8/2016 Liu et al.
 D764,876 S 8/2016 Liu et al.
 D764,877 S 8/2016 Liu et al.
 D764,878 S 8/2016 Liu et al.
 D764,879 S 8/2016 Gossens et al.
 D766,047 S 9/2016 Liu et al.
 D766,048 S 9/2016 Liu et al.
 9,693,644 B1 7/2017 Liu et al.
 2004/0031159 A1 2/2004 Rosenberg et al.
 2004/0148787 A1 8/2004 Rosenberg et al.
 2006/0117575 A1 6/2006 Tetreault et al.
 2007/0278165 A1 * 12/2007 Ranieri A47G 21/14
 211/70.7
 2008/0173772 A1 7/2008 Welch
 2009/0149120 A1 6/2009 Welch
 2012/0266468 A1 10/2012 Murphy et al.

* cited by examiner

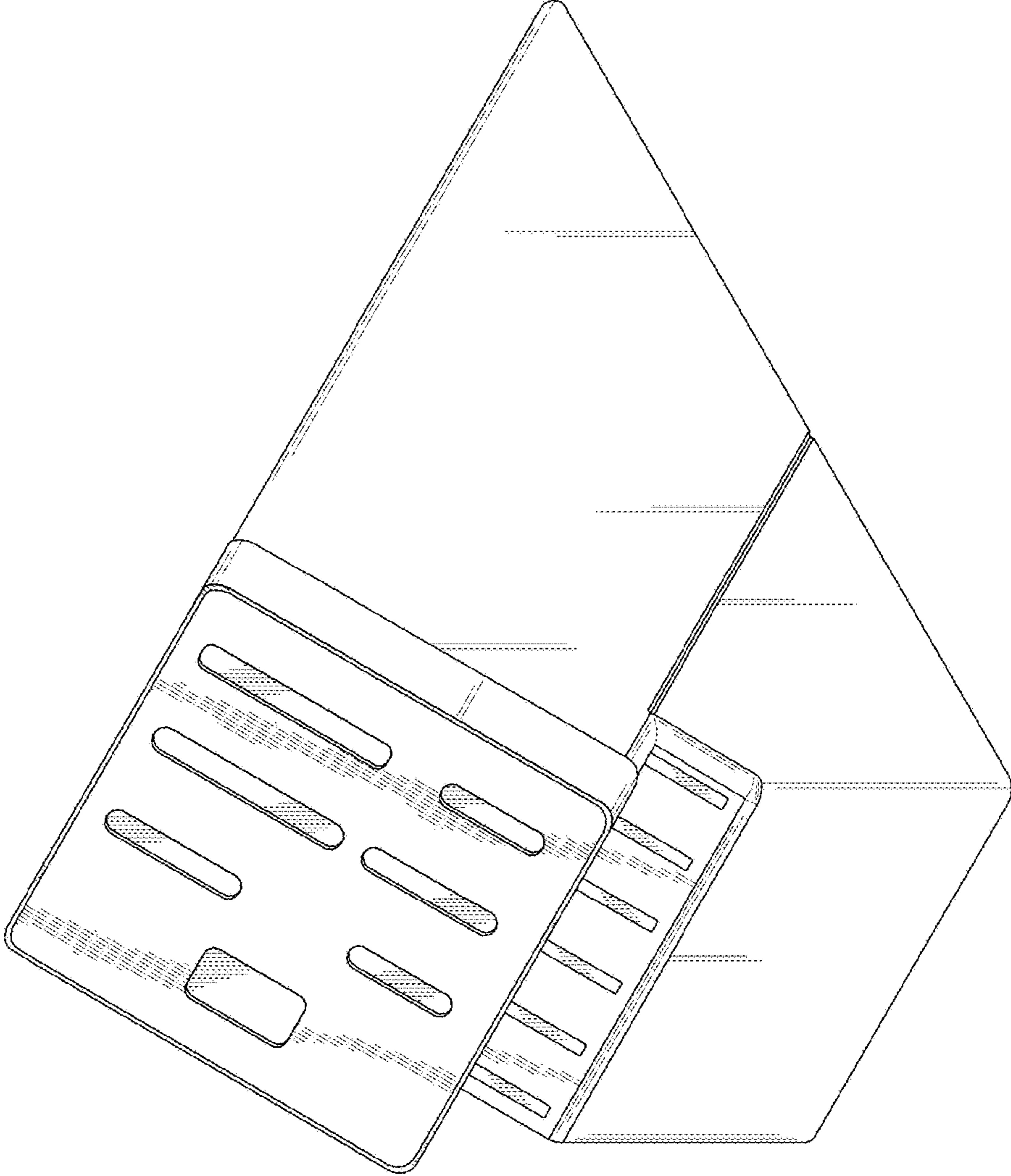

FIG. 1

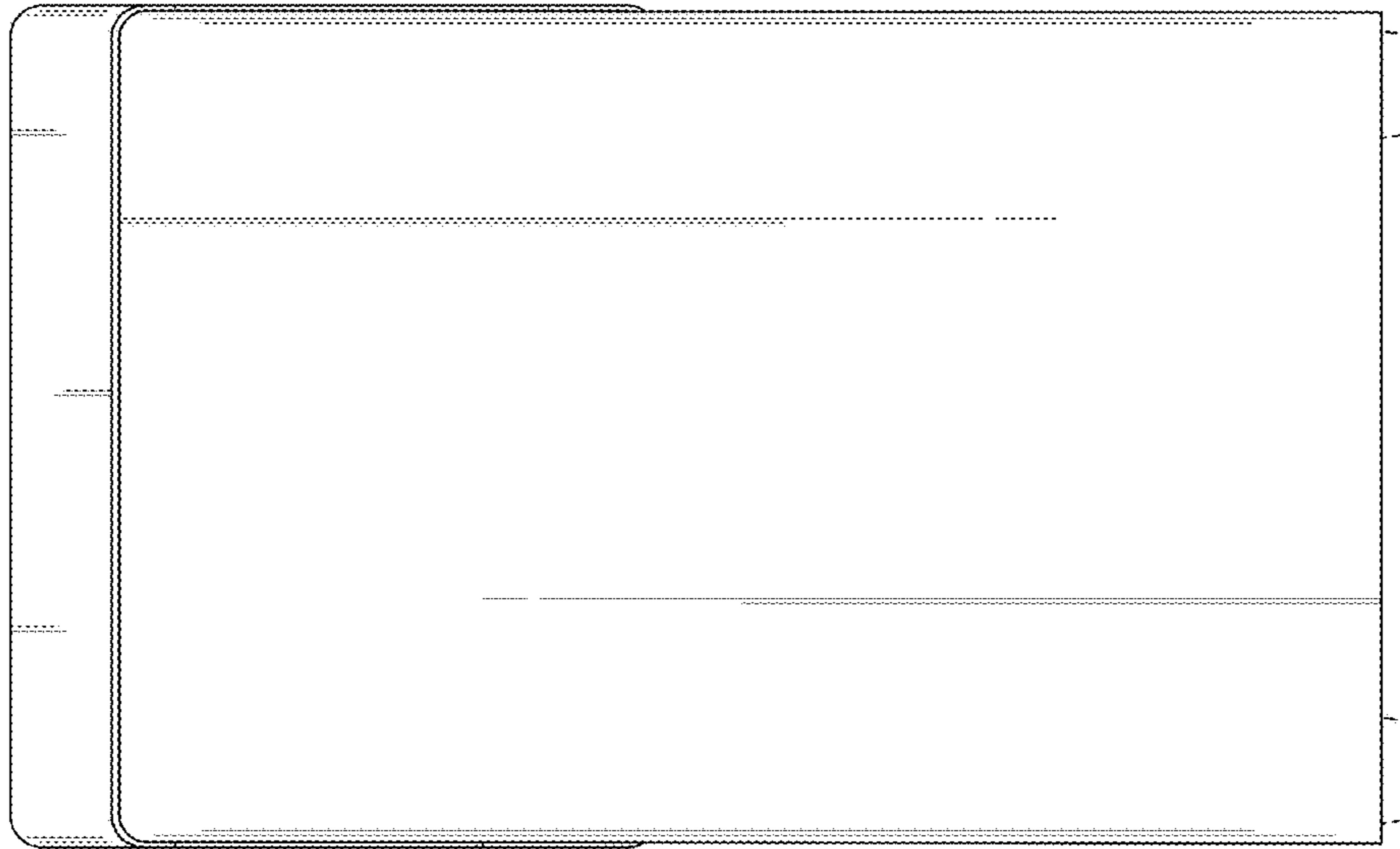

FIG. 3

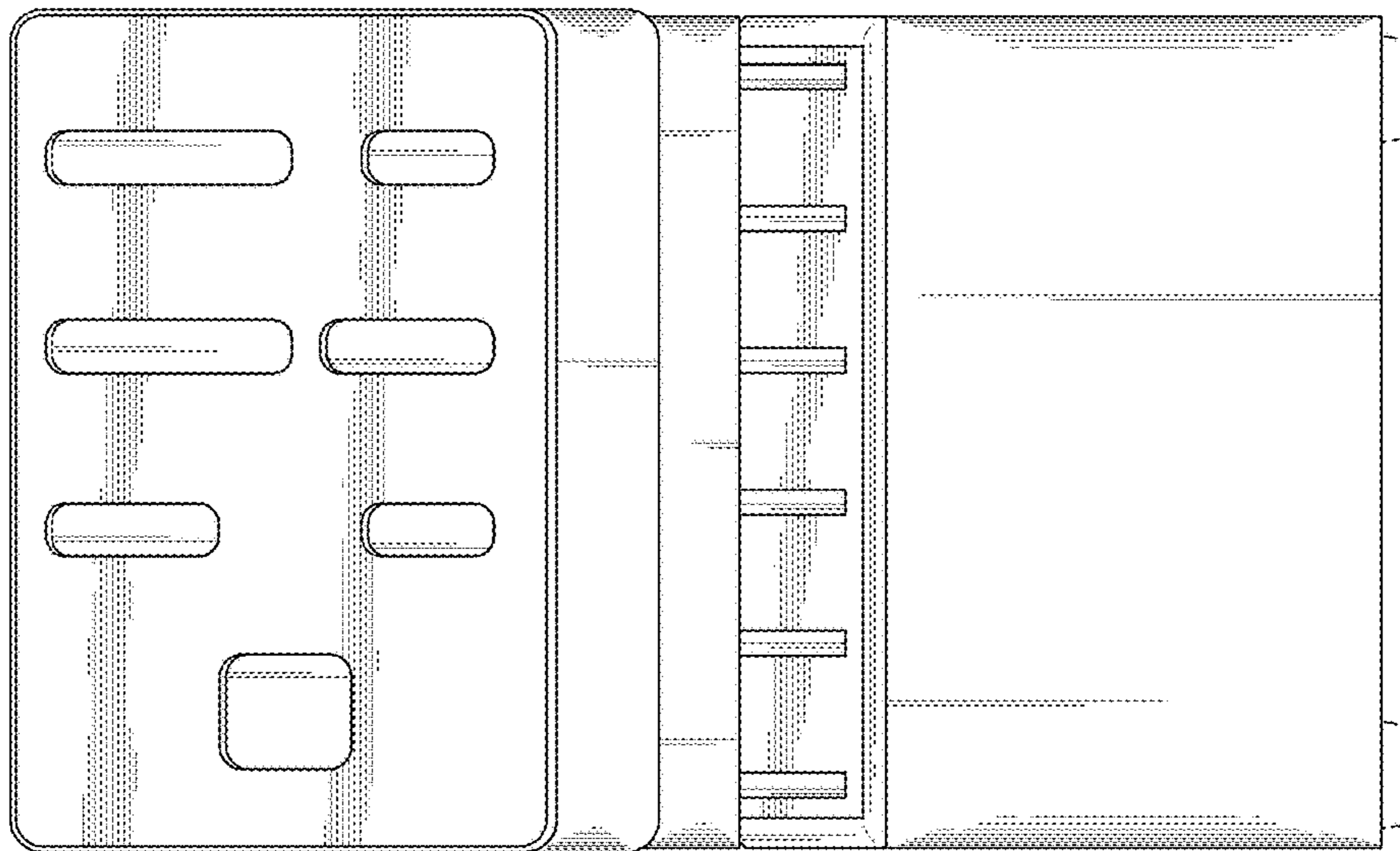

FIG. 2

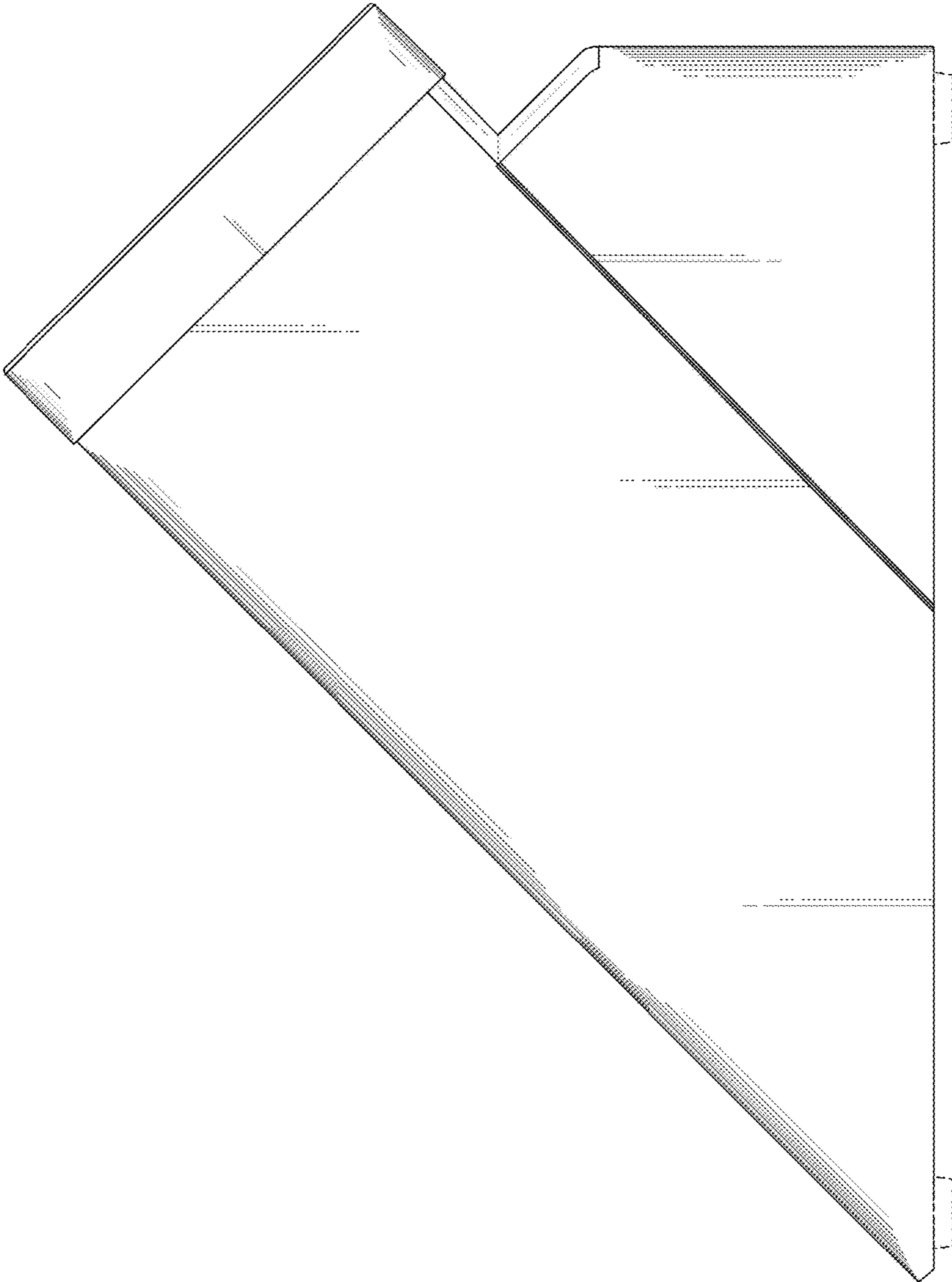

FIG. 4

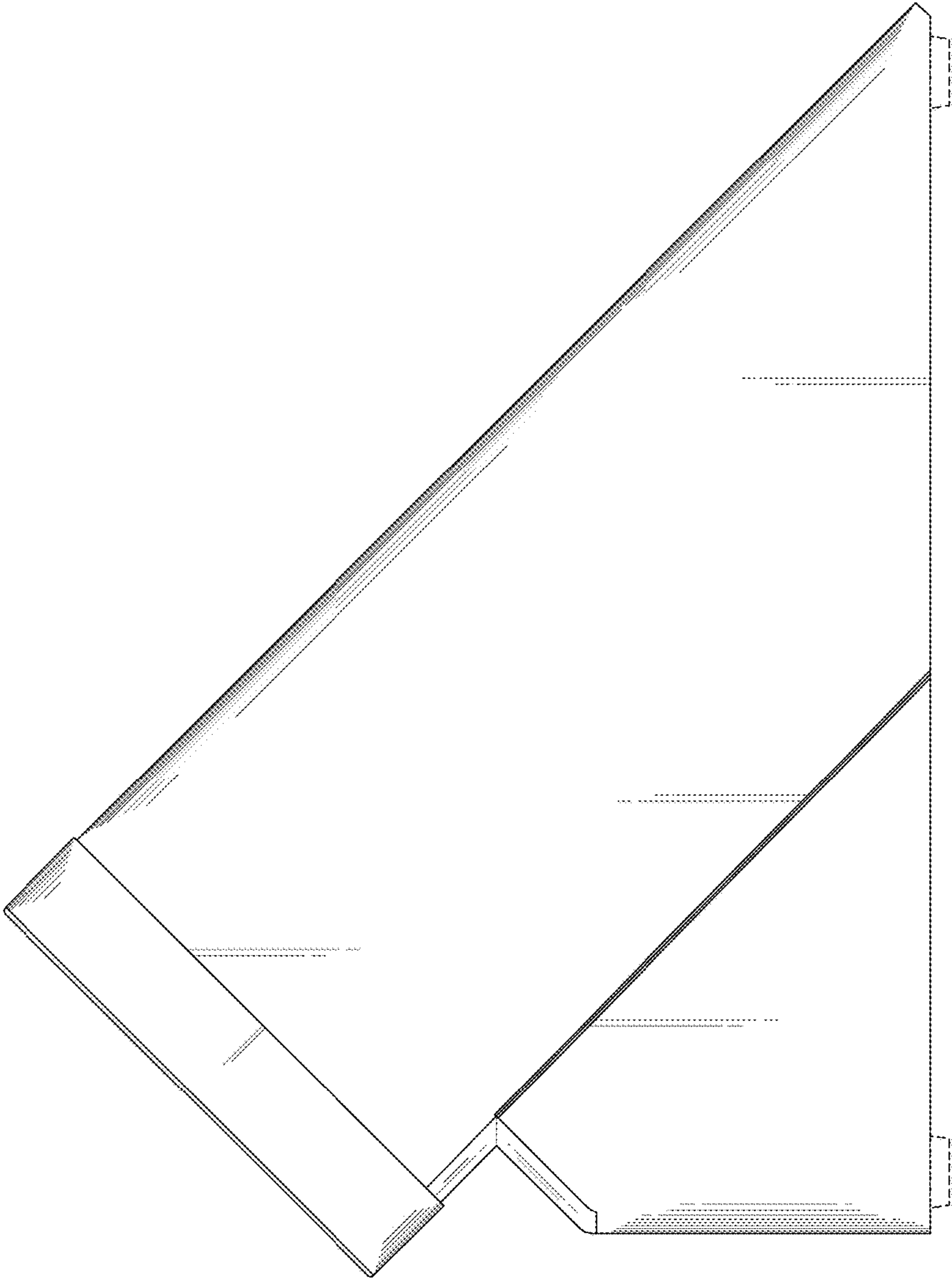

FIG. 5

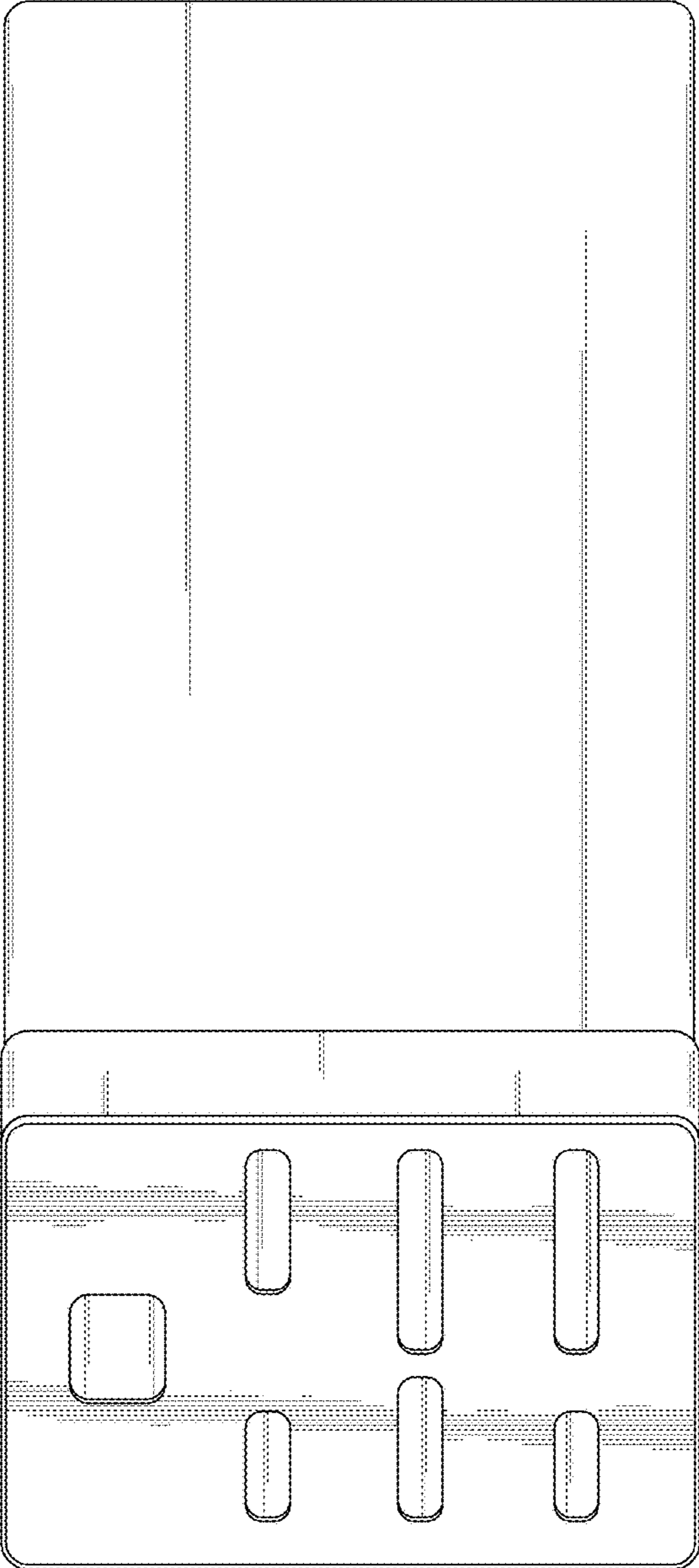

FIG. 6

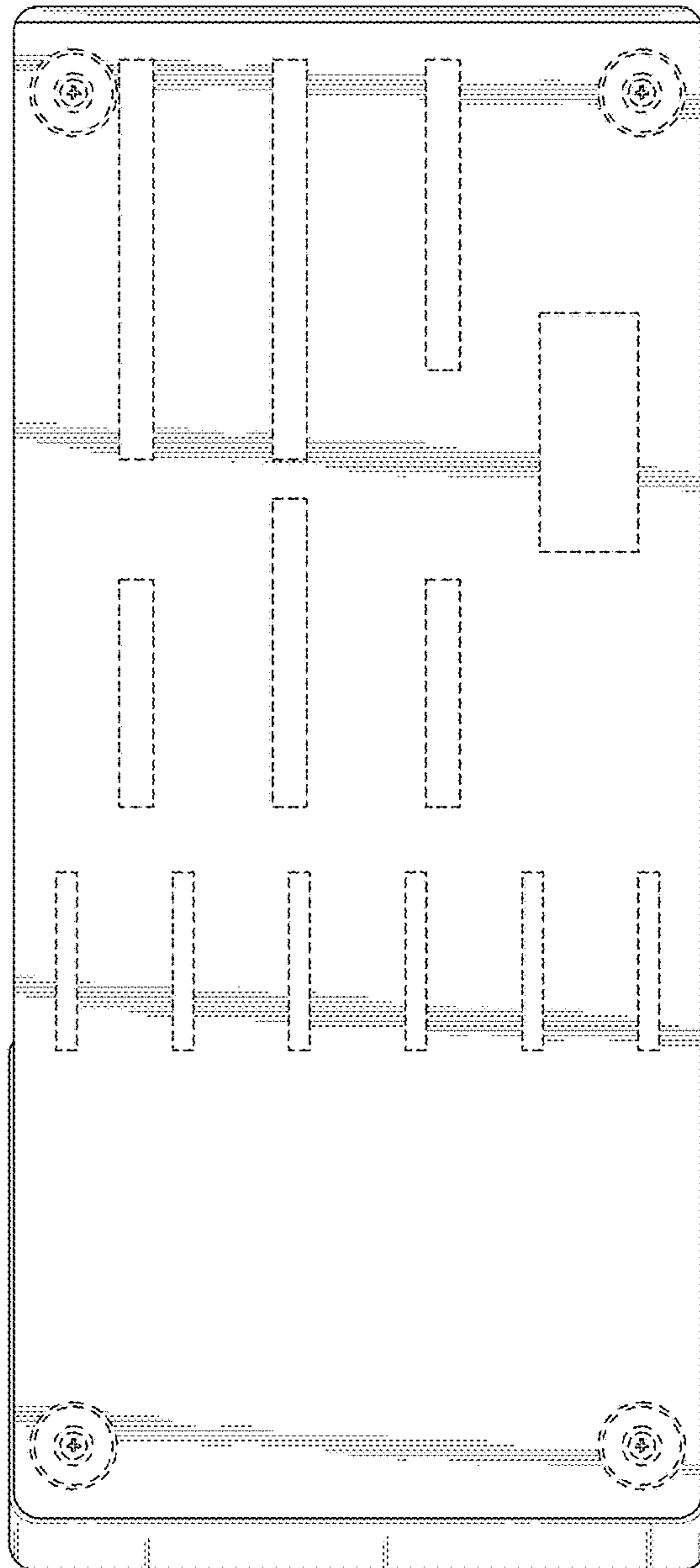

FIG. 7