



US00D851977S

(12) **United States Design Patent**
Krause

(10) **Patent No.:** **US D851,977 S**

(45) **Date of Patent:** **** Jun. 25, 2019**

- (54) **BED BARRIER**
- (71) Applicant: **Kevin P. Krause**, Lenexa, KS (US)
- (72) Inventor: **Kevin P. Krause**, Lenexa, KS (US)
- (**) Term: **15 Years**
- (21) Appl. No.: **29/637,213**
- (22) Filed: **Feb. 14, 2018**
- (51) **LOC (11) Cl.** **06-06**
- (52) **U.S. Cl.**
USPC **D6/718.3; D6/706; D6/718**
- (58) **Field of Classification Search**
USPC D6/383, 390, 718, 718.26, 718.3, 705,
D6/706, 716
CPC A47C 20/02; A47C 20/022; A47C 21/00;
A47C 21/08; A47F 5/005
See application file for complete search history.

- 5,161,704 A * 11/1992 Valiulis A47F 5/005
108/61
- D360,775 S * 8/1995 Karkoska 5/513
- D436,772 S * 1/2001 Soderstrom D6/574
- 6,488,031 B1 * 12/2002 Sells, II A61F 5/01
128/846
- D477,478 S * 7/2003 Davis D6/716
- D482,913 S * 12/2003 Lingvall A47B 57/583
D6/706
- D569,141 S * 5/2008 Tobias D6/706
- 9,737,151 B1 * 8/2017 Orlando A47C 21/00

* cited by examiner

Primary Examiner — Cathron C Brooks

(74) *Attorney, Agent, or Firm* — Intellent Patents LLC

(57) **CLAIM**

The ornamental design for a bed barrier, as shown and described.

DESCRIPTION

FIG. 1 is a top perspective view thereof;
FIG. 2 is a front view thereof;
FIG. 3 is a back view thereof;
FIG. 4 is a right side view thereof;
FIG. 5 is a left side view thereof;
FIG. 6 is a bottom view thereof; and,
FIG. 7 is a top view thereof.

1 Claim, 6 Drawing Sheets

(56) **References Cited**

U.S. PATENT DOCUMENTS

- 2,471,977 A * 5/1949 Power A47C 21/00
211/184
- 2,510,656 A * 6/1950 Randel A47C 21/00
5/513
- 3,780,876 A * 12/1973 Elkins A47F 5/005
211/184
- 4,775,058 A * 10/1988 Yatsko A47F 5/005
108/61

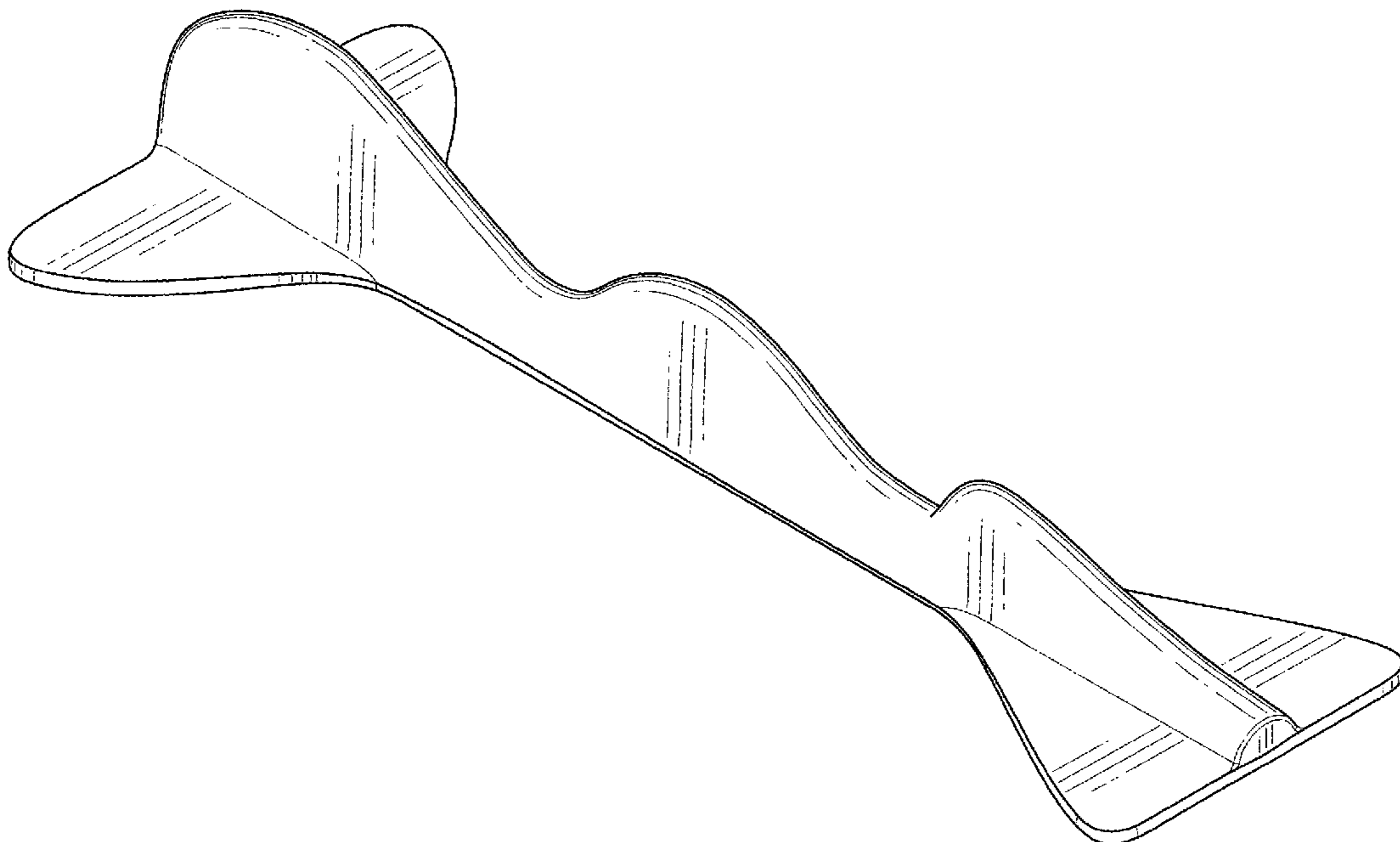

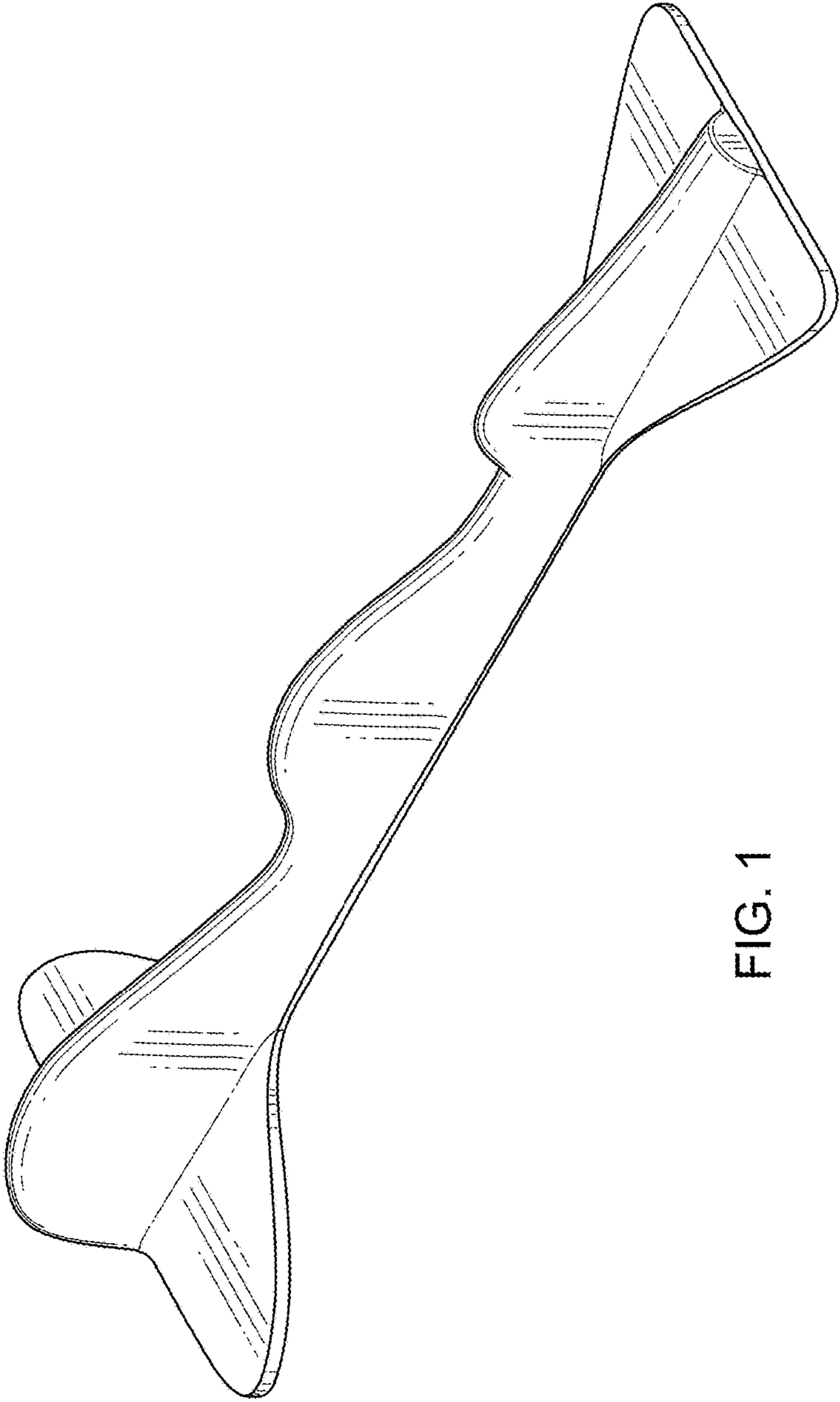

FIG. 1

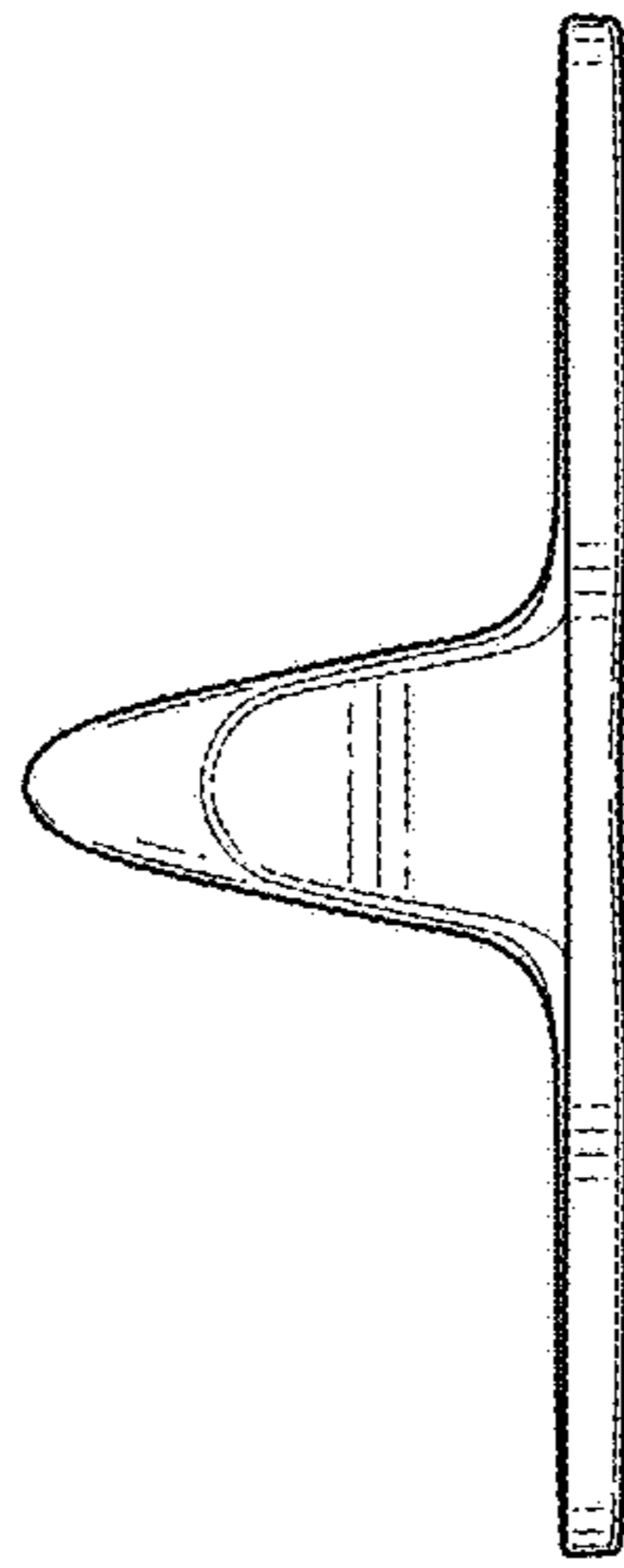

FIG. 3

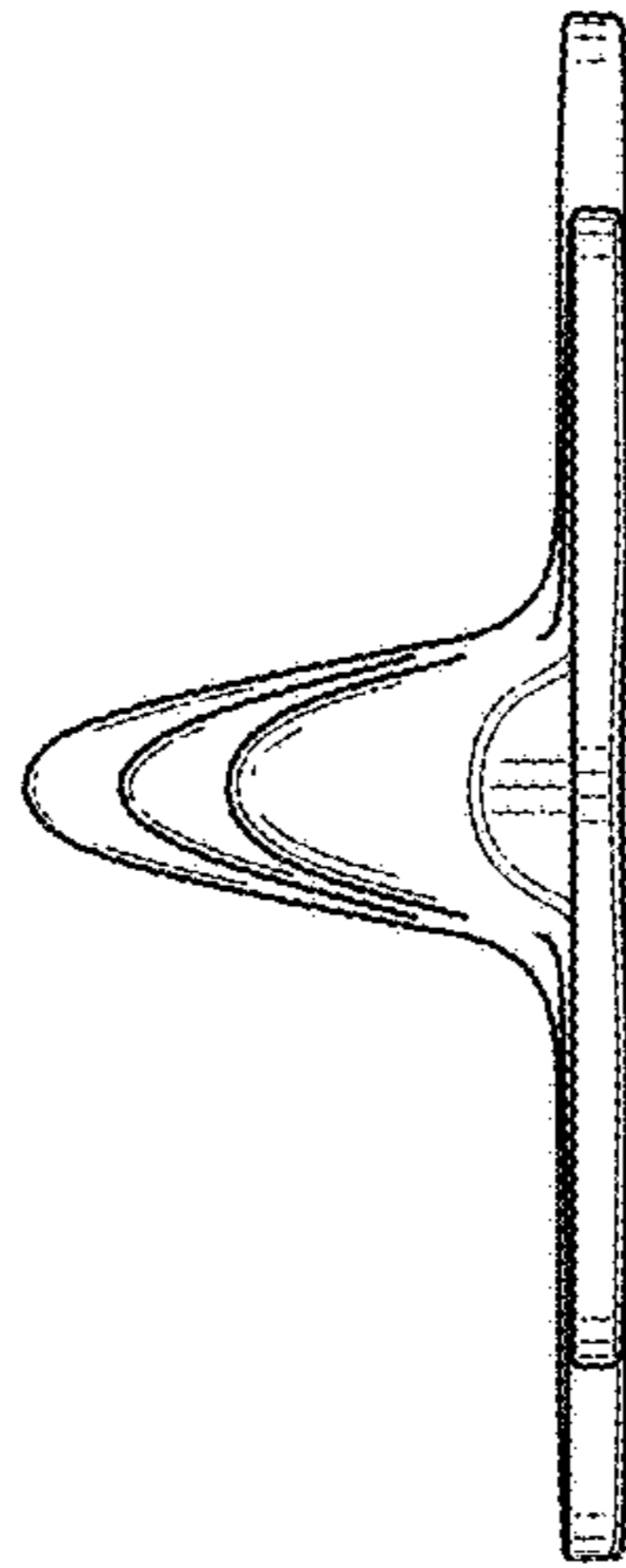

FIG. 2

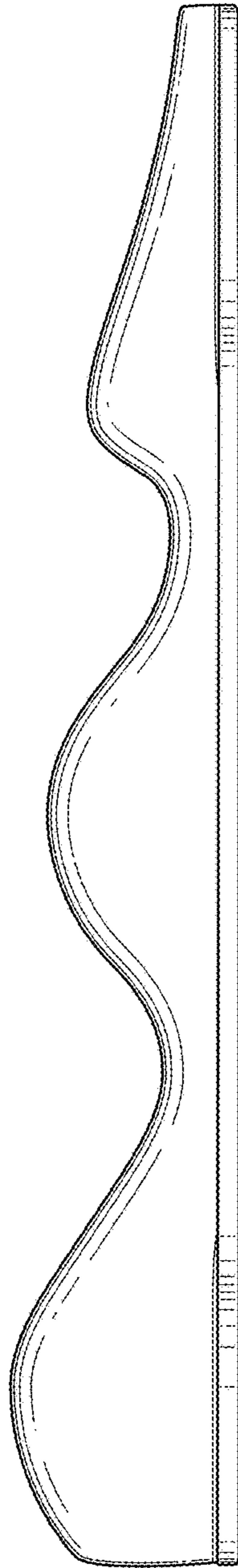

FIG. 4

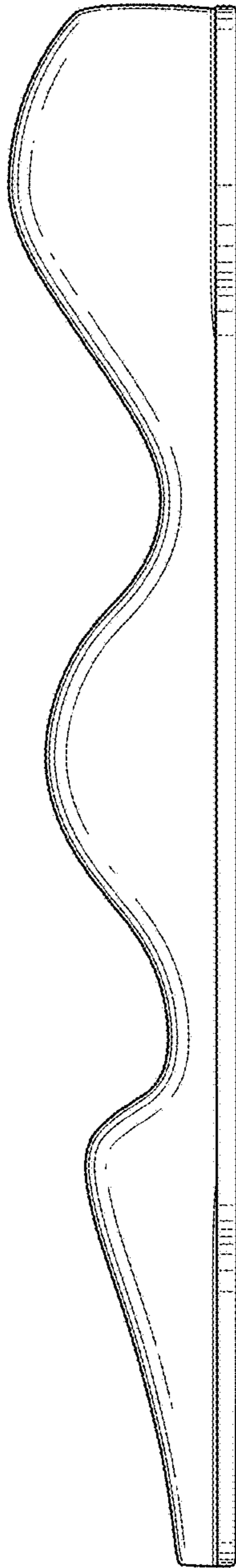

FIG. 5

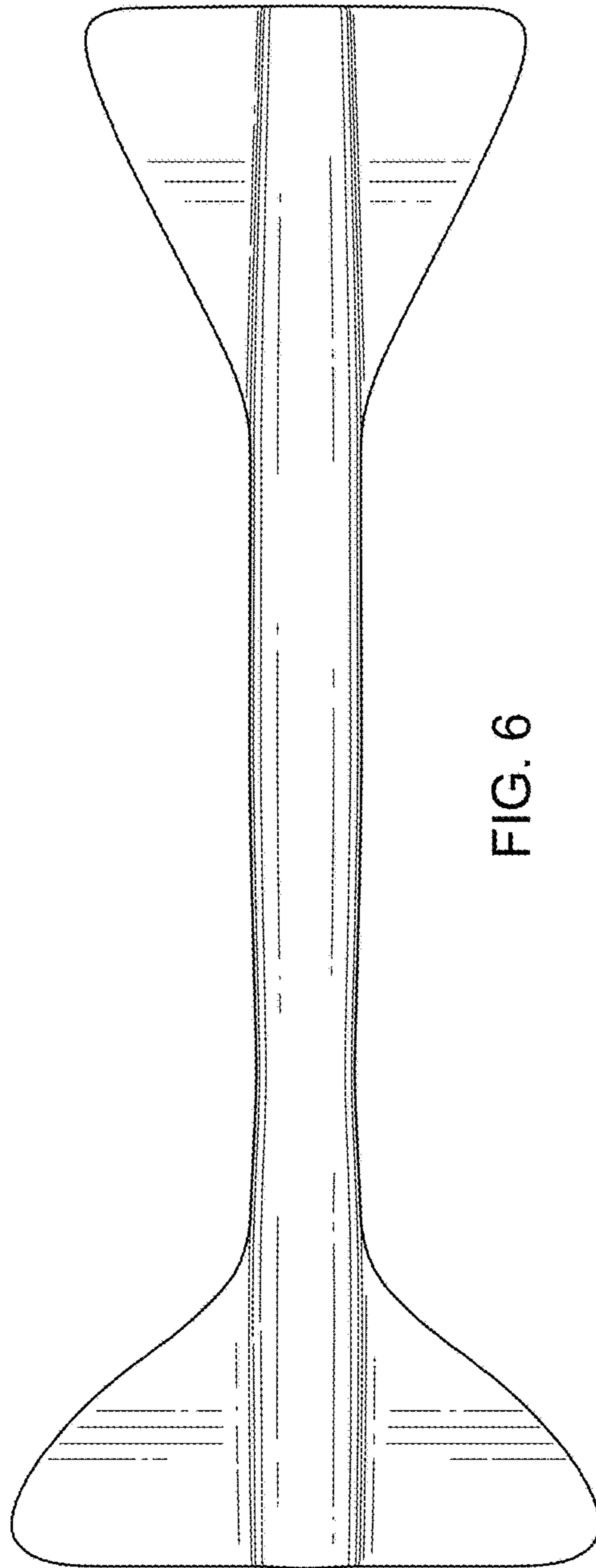

FIG. 6

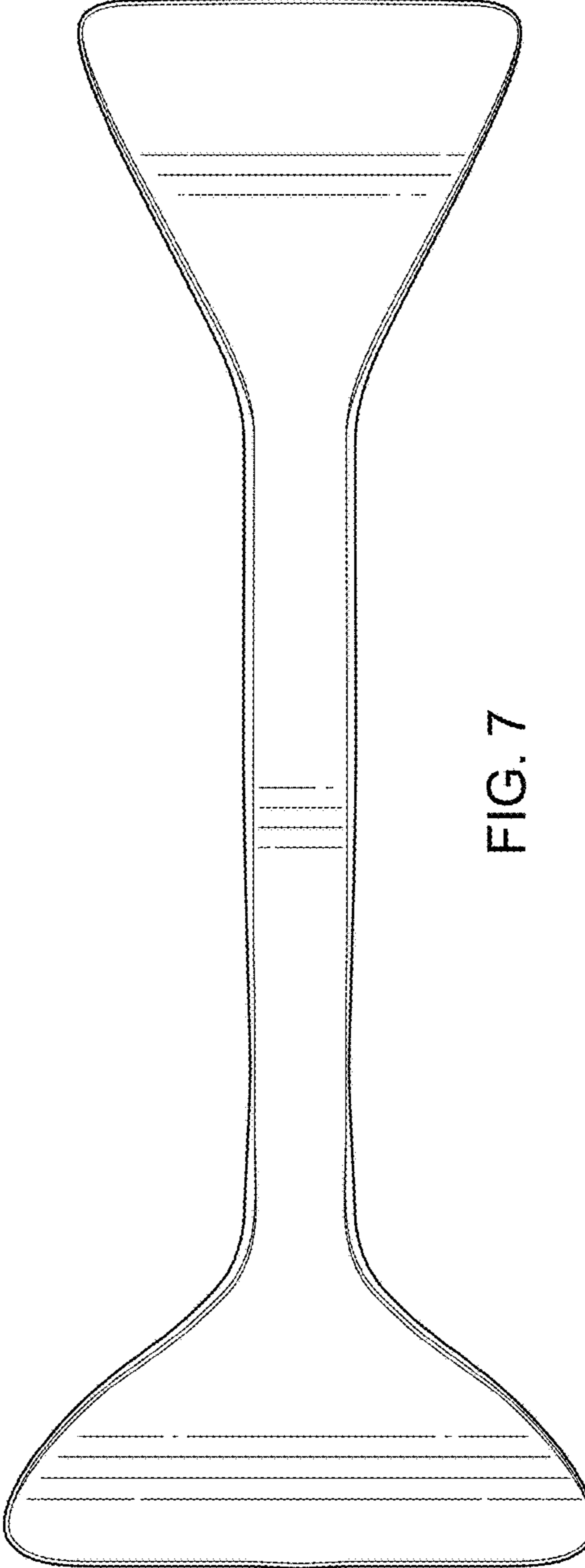

FIG. 7