



US00D851909S

(12) **United States Design Patent**  
**Casha**

(10) **Patent No.:** **US D851,909 S**  
(45) **Date of Patent:** **\*\* Jun. 25, 2019**

(54) **REUSABLE TOTE BAG WITH ATTACHED CARRY POUCH**

(71) Applicant: **Debra A. Casha**, Fair Oaks, CA (US)

(72) Inventor: **Debra A. Casha**, Fair Oaks, CA (US)

(\*\*) Term: **15 Years**

(21) Appl. No.: **29/547,784**

(22) Filed: **Dec. 8, 2015**

(51) **LOC (11) Cl.** ..... **03-01**

(52) **U.S. Cl.**  
USPC ..... **D3/201**

(58) **Field of Classification Search**

USPC ..... D3/201, 205, 242, 273, 274, 275, 276,  
D3/279, 281, 282, 283, 284, 289, 292,  
D3/294, 295, 296, 297, 299, 301, 302,  
D3/901, 903, 905; D9/414

CPC ..... A45C 5/04; A45C 11/00; A45C 11/16  
See application file for complete search history.

(56) **References Cited**

**U.S. PATENT DOCUMENTS**

D246,940 S *	1/1978	Sabol	.....	D3/246
D590,150 S *	4/2009	Miller	.....	D3/246
D608,089 S *	1/2010	McCoy	.....	D3/232
D631,654 S *	2/2011	Lizhu	.....	D3/233
D641,157 S *	7/2011	Steele	.....	D3/232
D653,849 S *	2/2012	Jariwala	.....	D3/232
D702,435 S *	4/2014	Kriemler	.....	D3/232
D740,022 S *	10/2015	Chadwell	.....	D3/232
D751,288 S *	3/2016	Majmundar	.....	A45C 9/00
				D3/233
D762,378 S *	8/2016	Domotor	.....	D3/233
D784,687 S *	4/2017	Miller	.....	D3/232

\* cited by examiner

*Primary Examiner* — Holly E Thurman

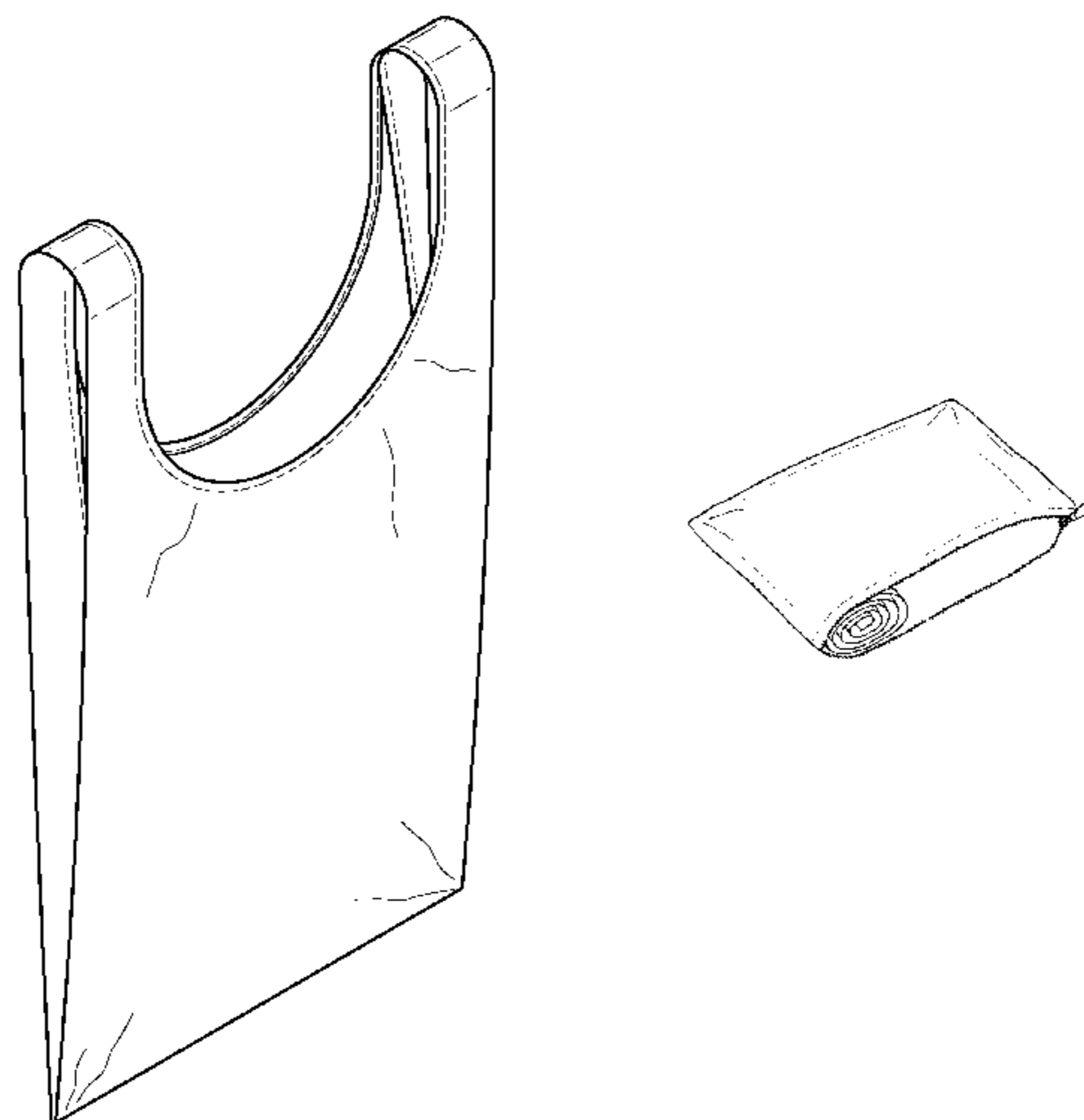
(57) **CLAIM**

I claim the ornamental design for a reusable tote bag with attached carry pouch, as shown and described.

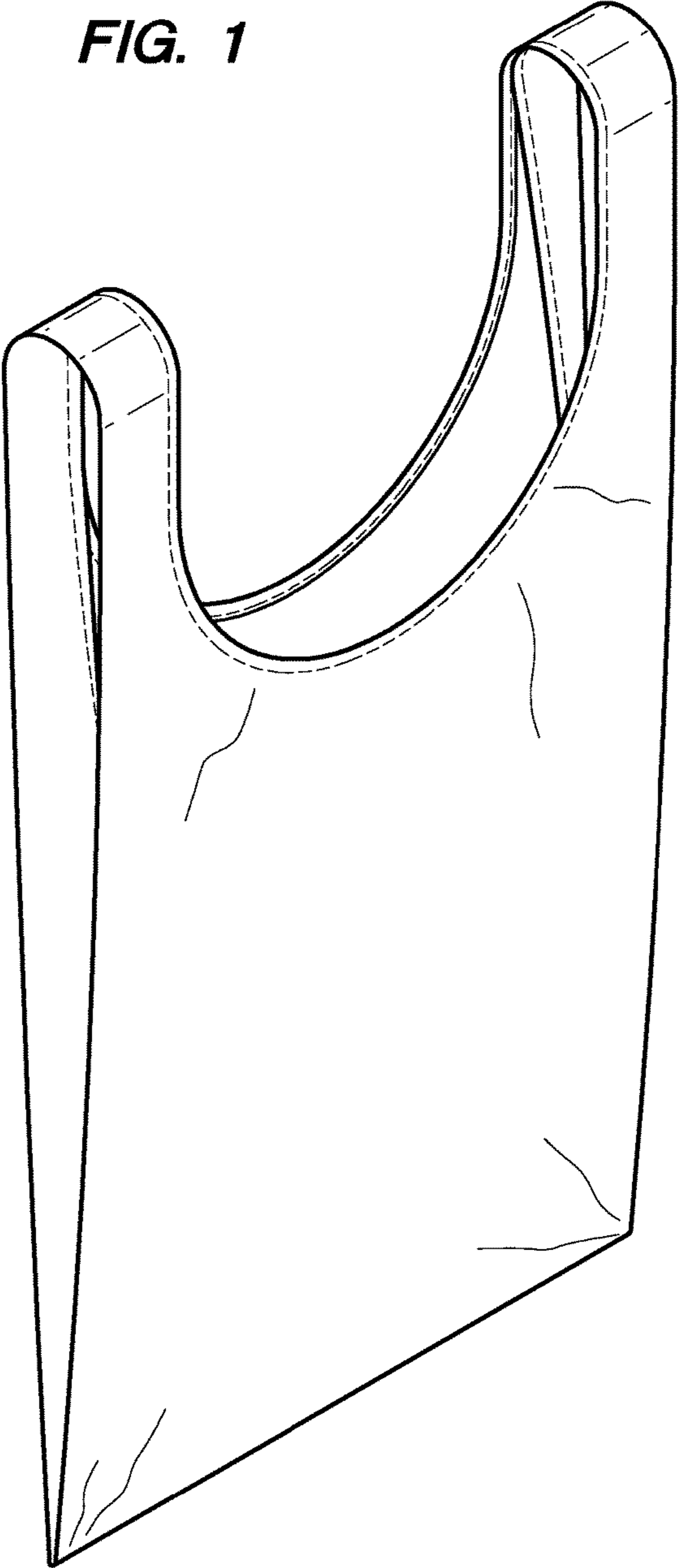
**DESCRIPTION**

FIG. 1 is a top perspective view of reusable tote bag with attached carry pouch showing my new design;  
 FIG. 2 is a front elevation view thereof;  
 FIG. 3 is a top plan view defining cross sectional plane 6-6 thereof;  
 FIG. 4 is a bottom plan view thereof;  
 FIG. 5 is a both a left side and right side elevation view thereof;  
 FIG. 6 is a cross sectional view taken from line 6-6 in FIG. 3.  
 FIG. 7 is a top perspective view of reusable tote bag with attached carry pouch turned inside out showing my new design;  
 FIG. 8 is a front elevation view thereof;  
 FIG. 9 is a top plan view thereof;  
 FIG. 10 is a right side elevation view thereof;  
 FIG. 11 is a rear elevation view thereof;  
 FIG. 12 is a left side elevation view thereof;  
 FIG. 13 is a bottom plan view thereof;  
 FIG. 14 is a top perspective view of reusable tote bag with attached carry pouch turned inside out, rolled, and tucked inside the attached carry pouch showing my new design;  
 FIG. 15 is a front elevation view thereof;  
 FIG. 16 is a rear elevation view thereof;  
 FIG. 17 is a left side elevation view thereof;  
 FIG. 18 is a right side elevation view thereof;  
 FIG. 19 is a top elevation view thereof; and,  
 FIG. 20 is a bottom elevation view thereof.  
 The broken lines represent subject matter that forms no part of the claimed design.

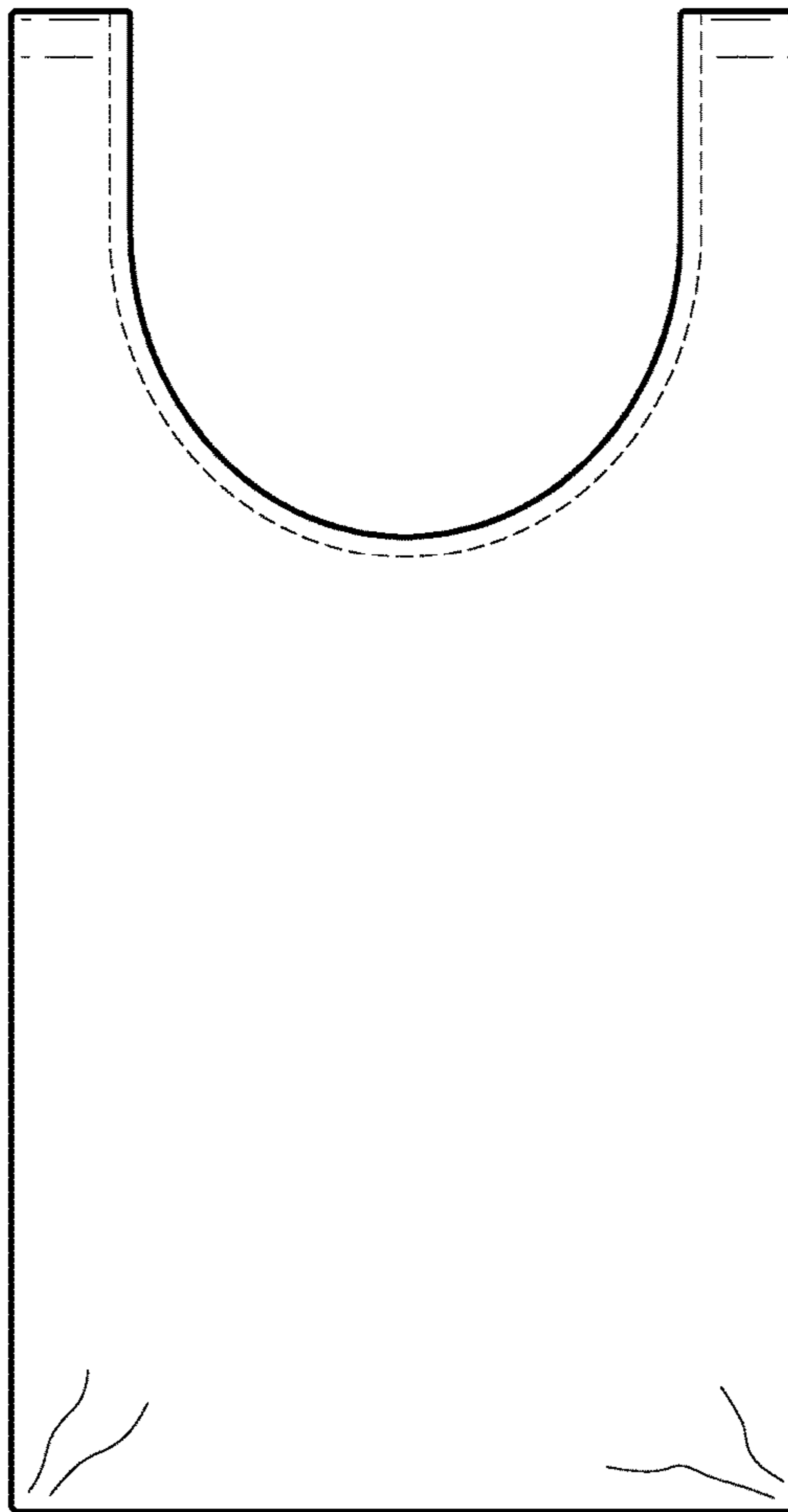
**1 Claim, 9 Drawing Sheets**



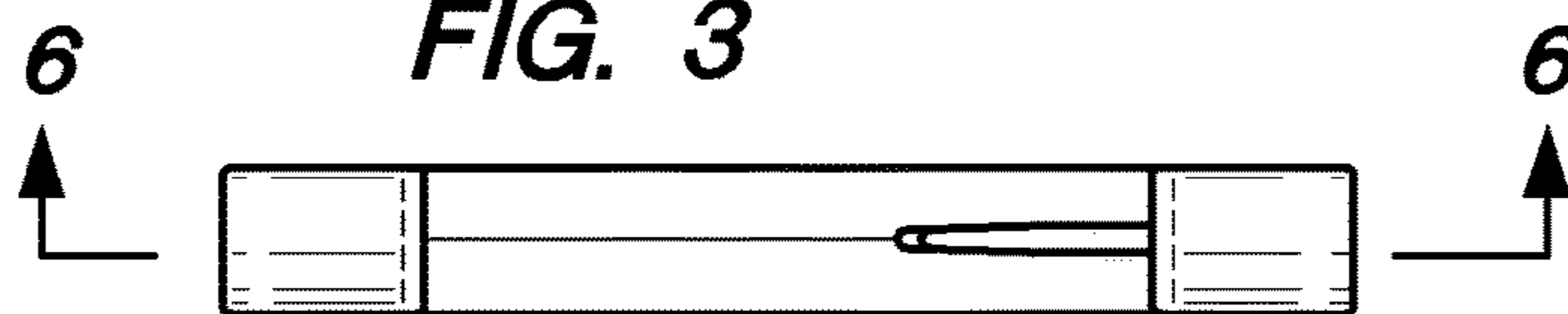
**FIG. 1**



**FIG. 2**



**FIG. 3**



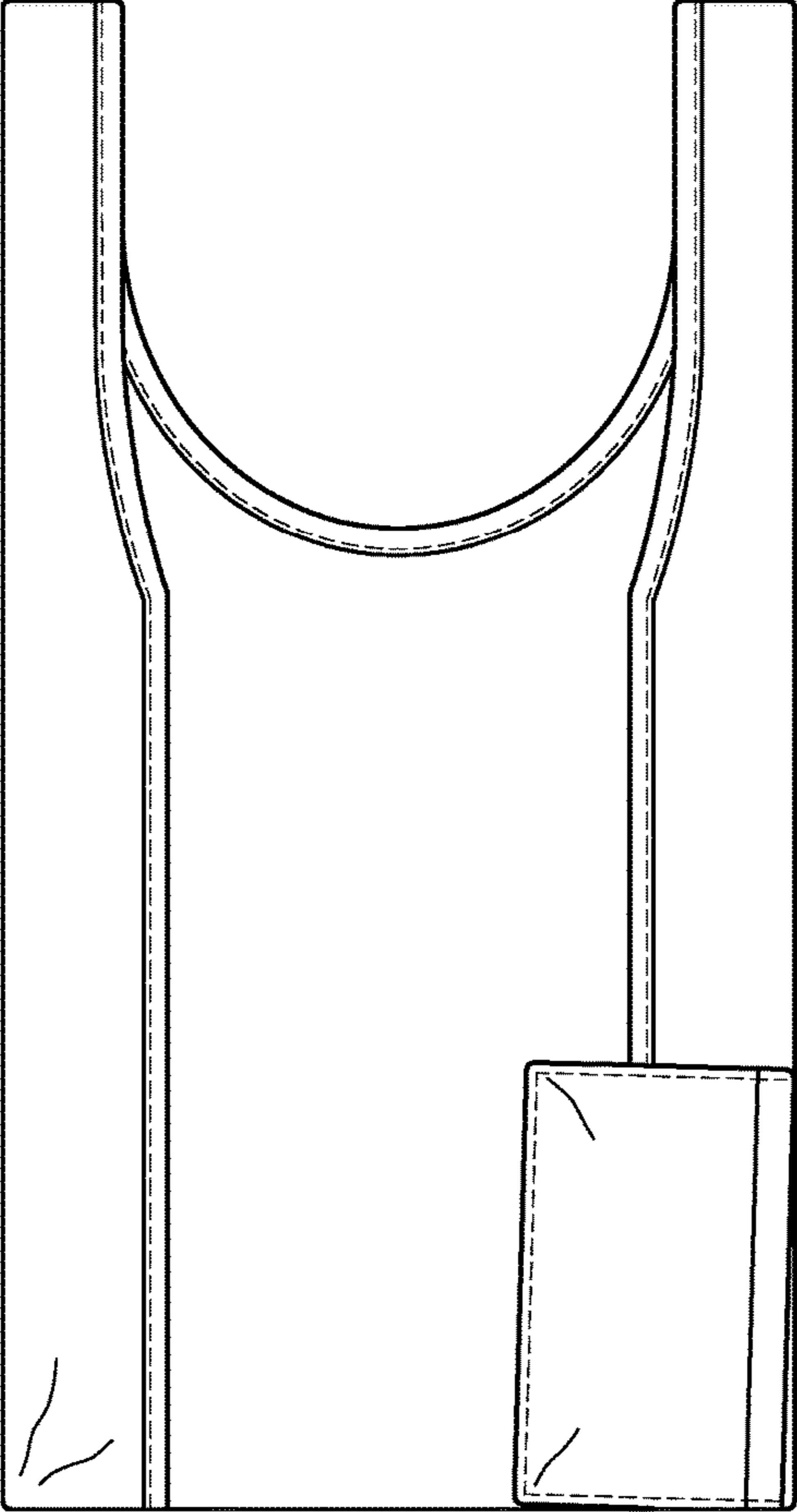
**FIG. 4**



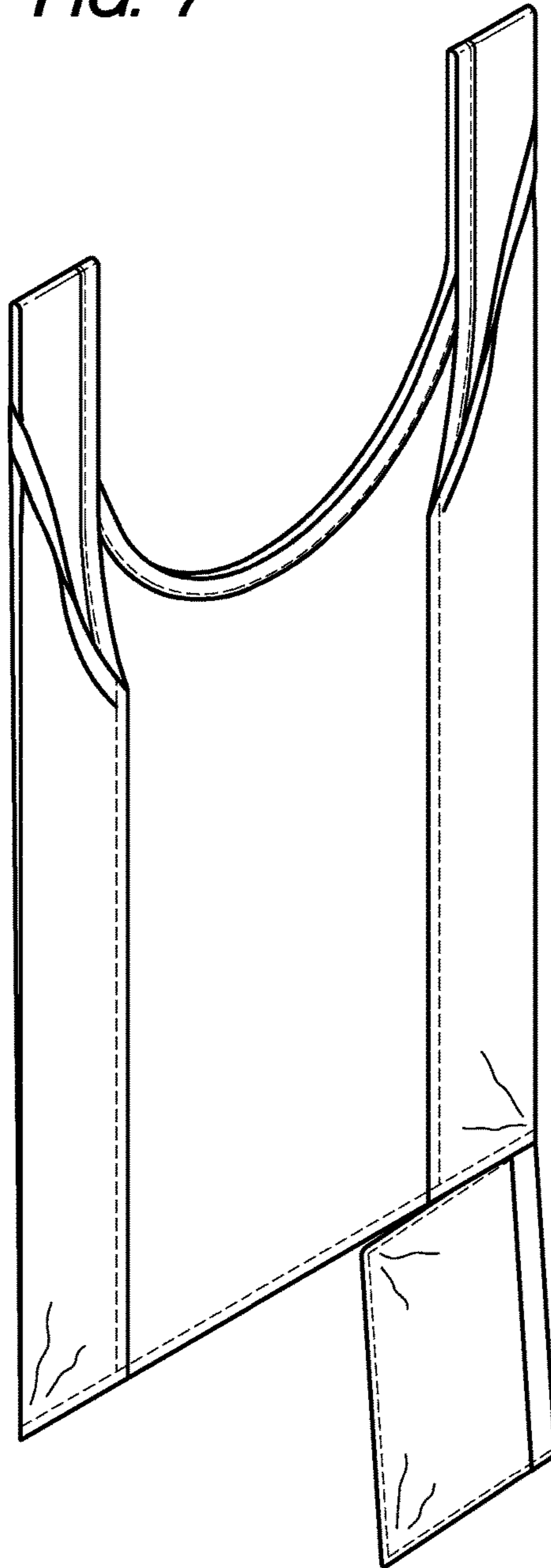
**FIG. 5**



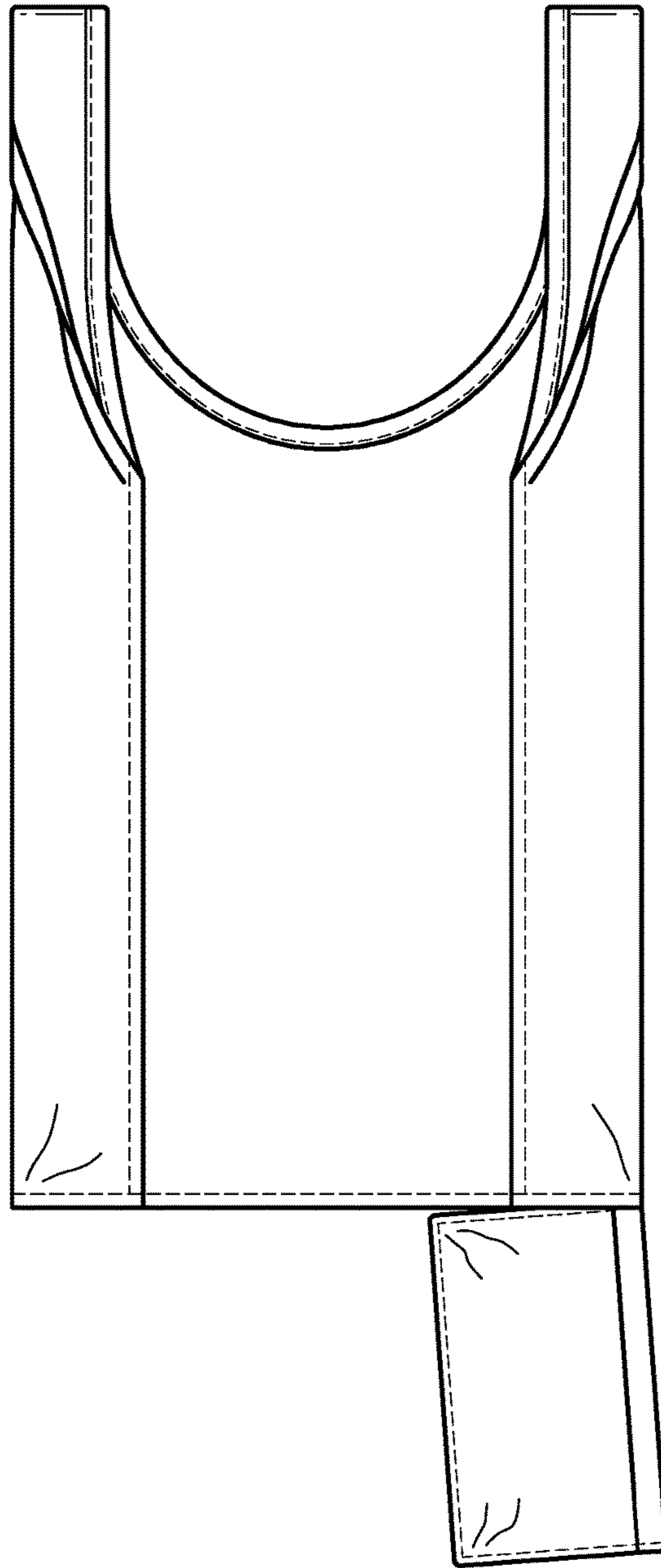
**FIG. 6**



**FIG. 7**



**FIG. 8**



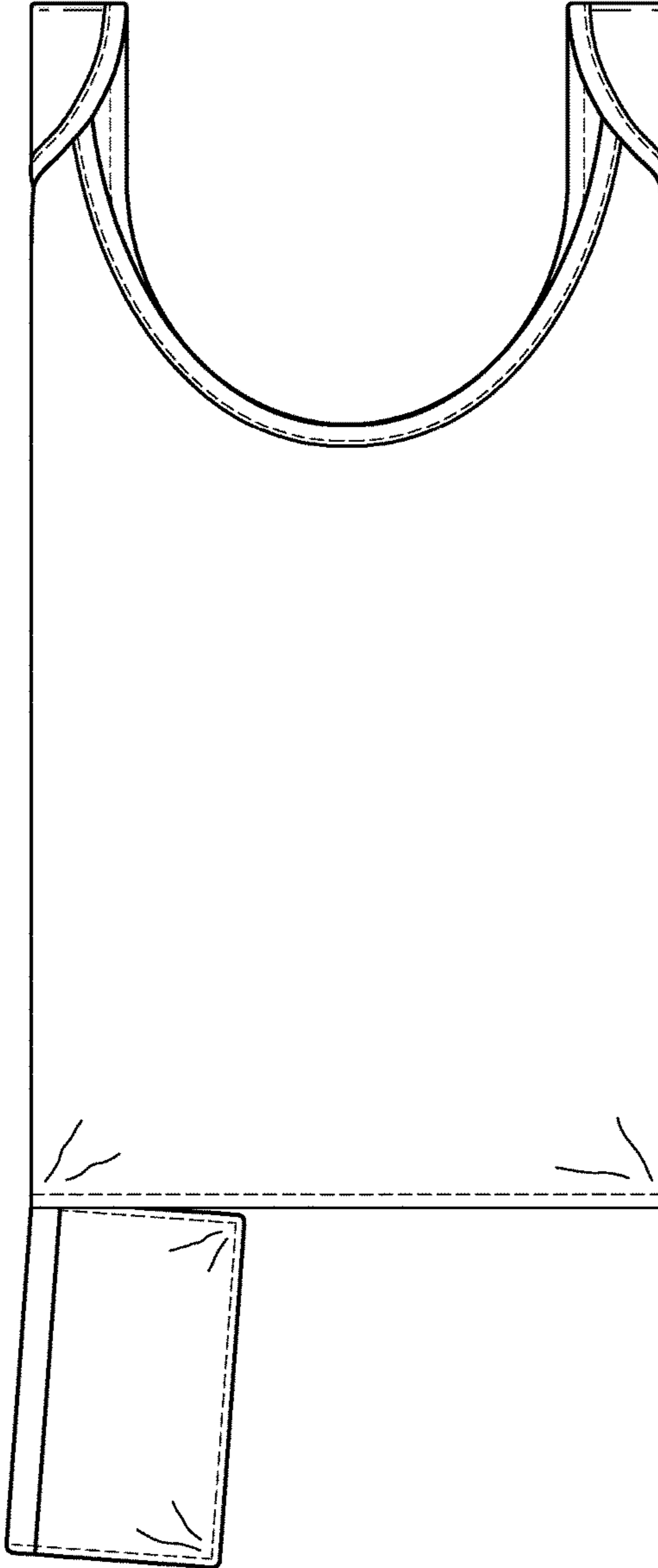
**FIG. 9**



**FIG. 10**



**FIG. 11**



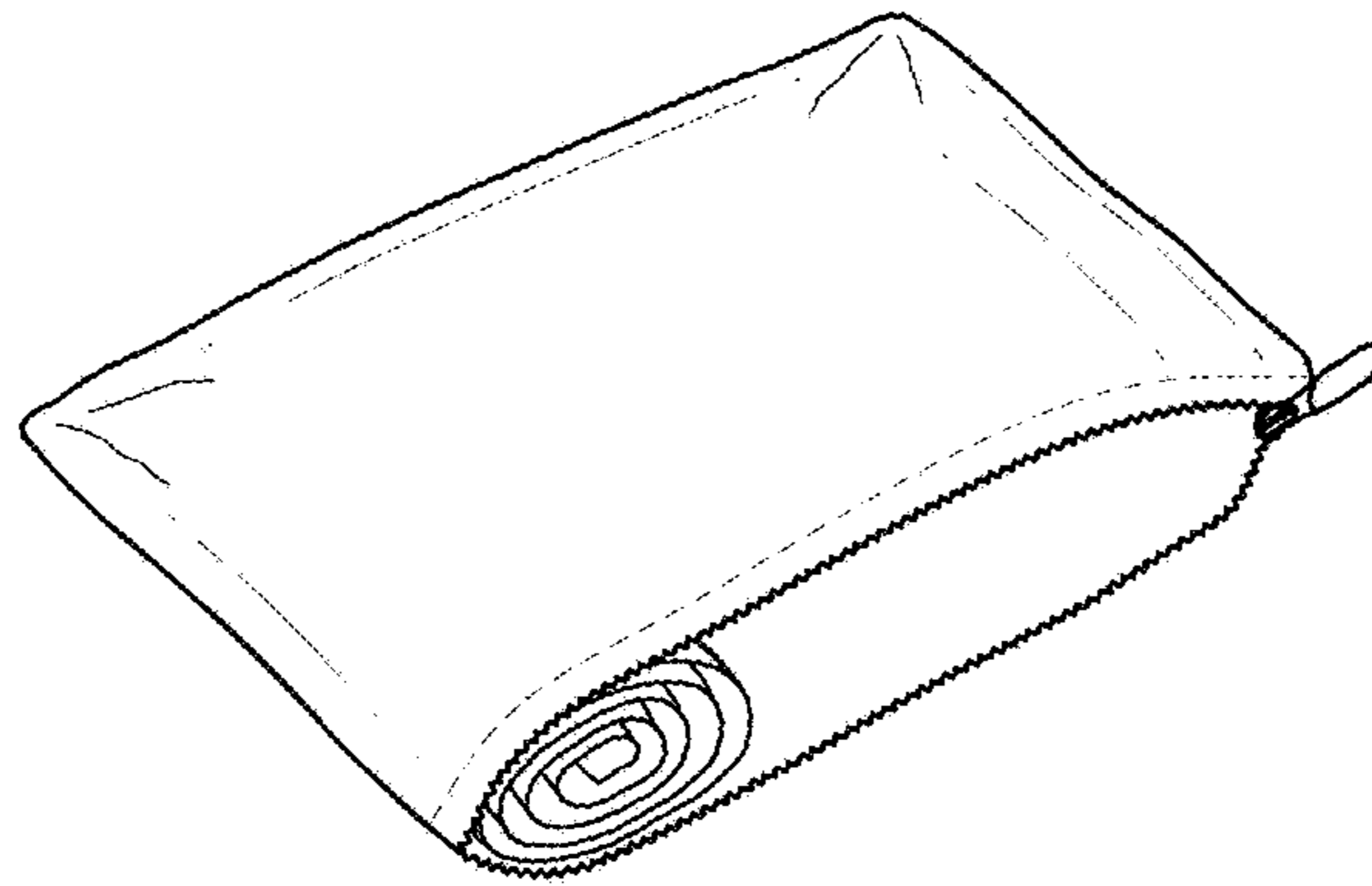
**FIG. 12**



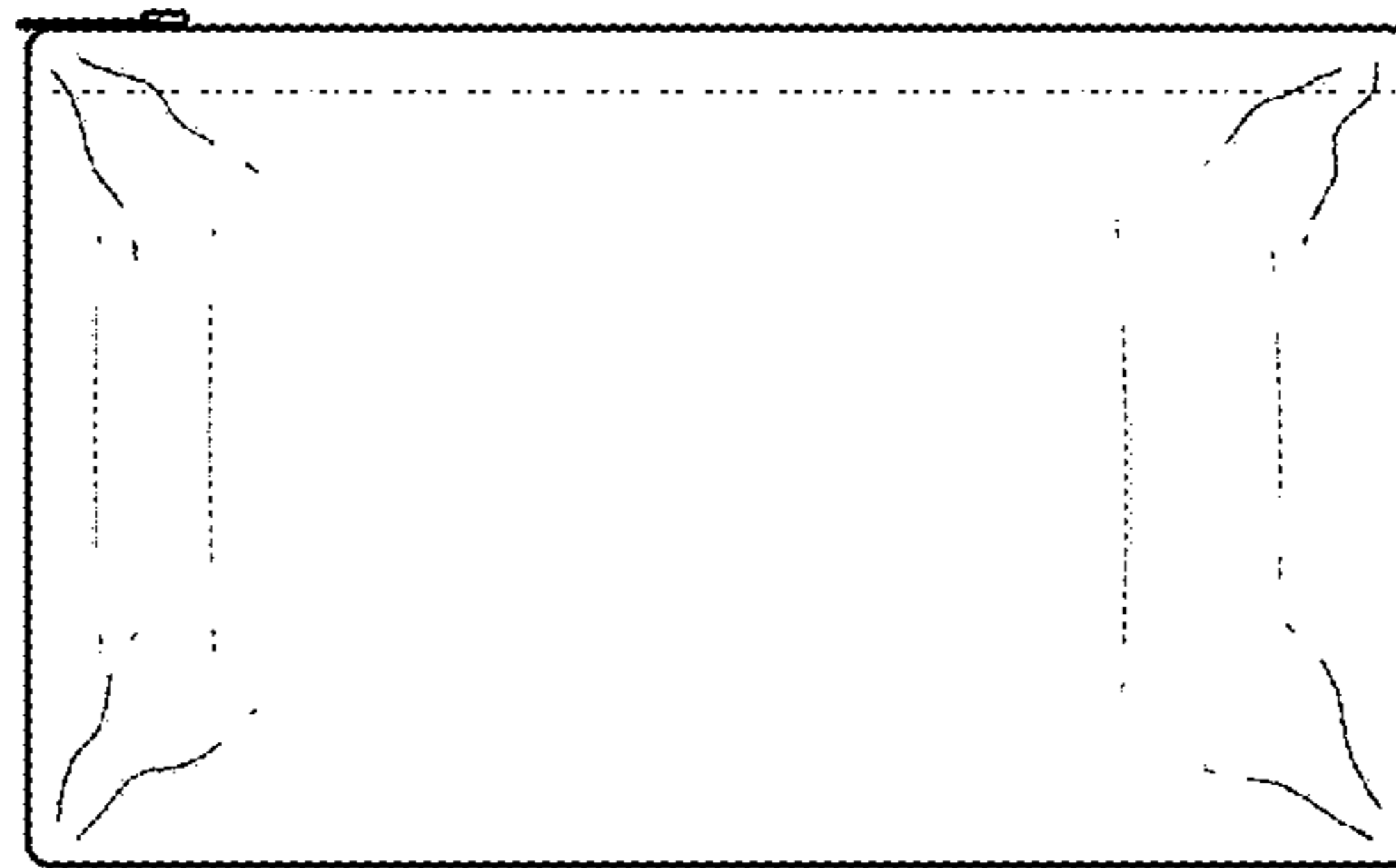
**FIG. 13**



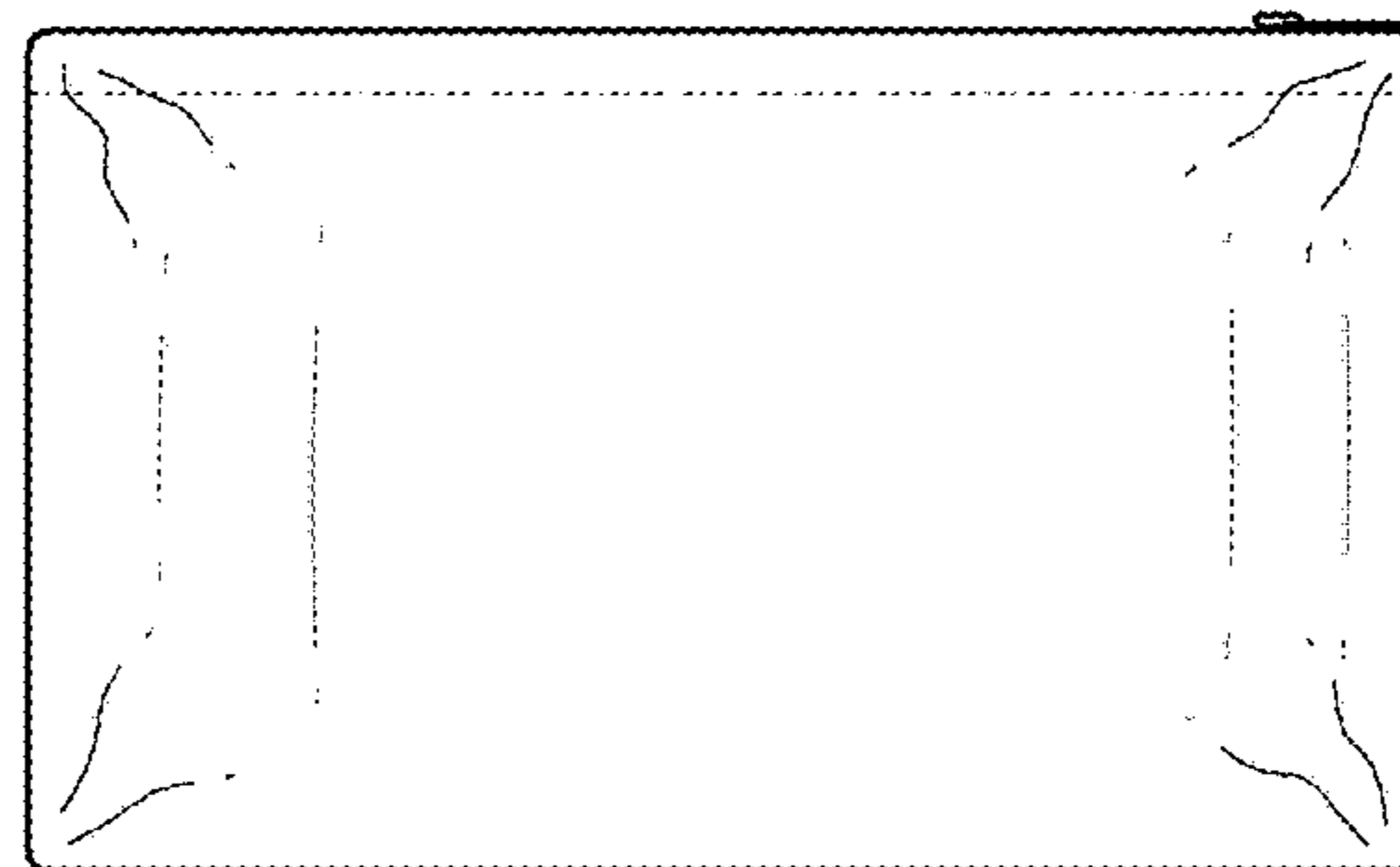




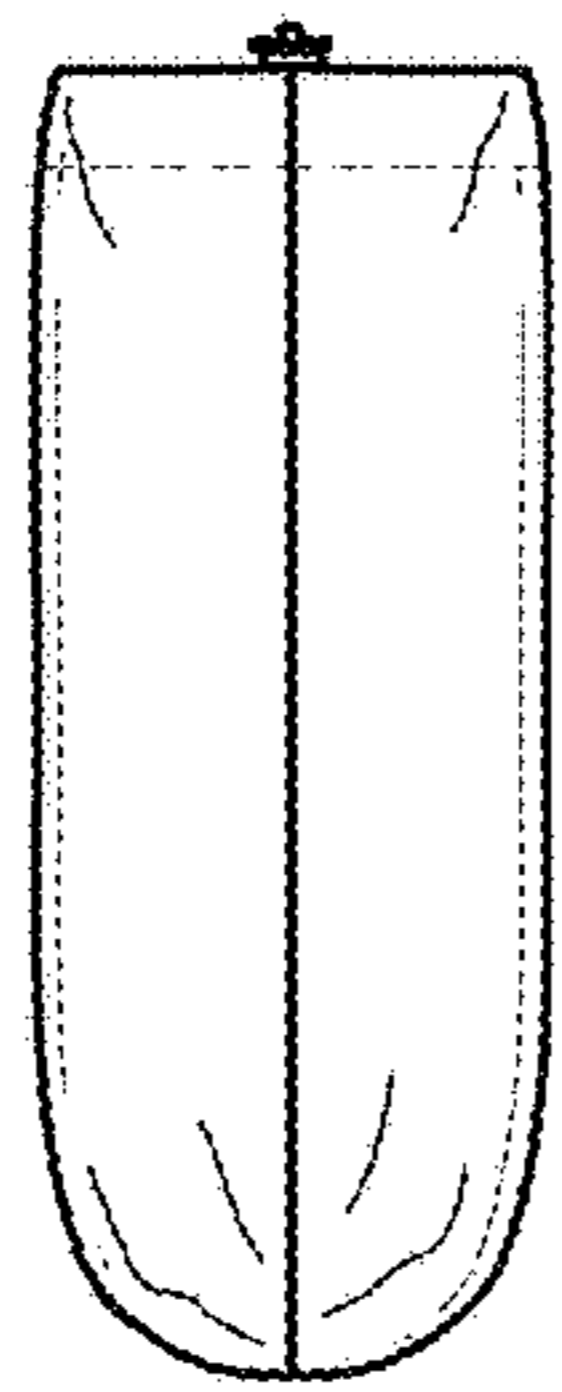
**FIG. 14**



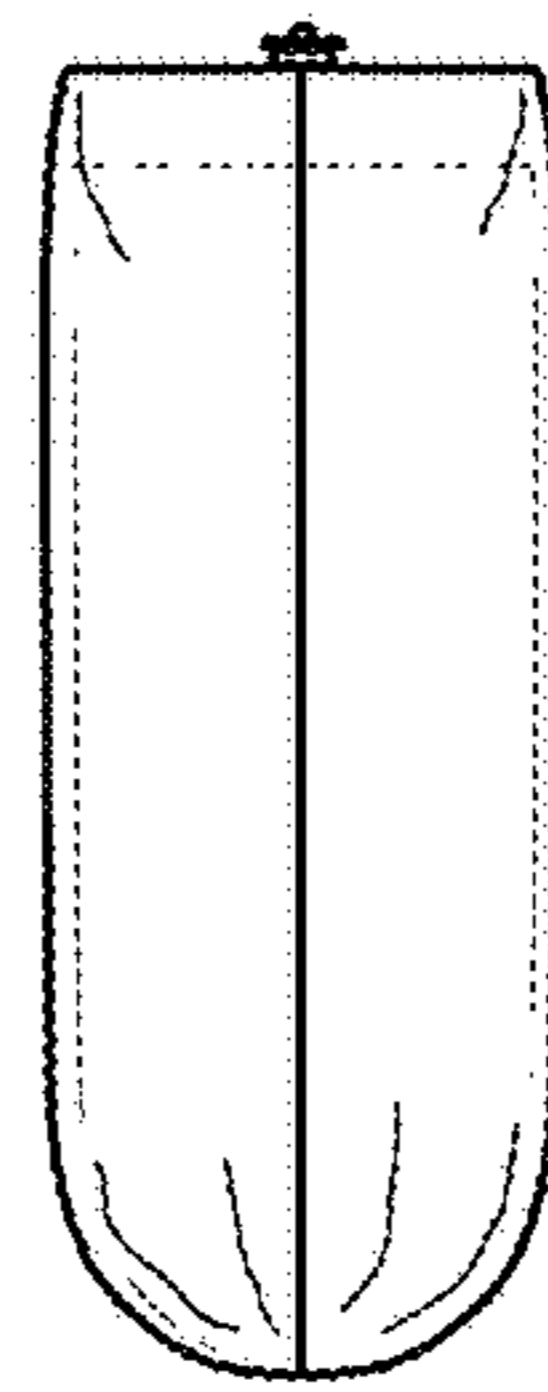
**FIG. 15**



**FIG. 16**



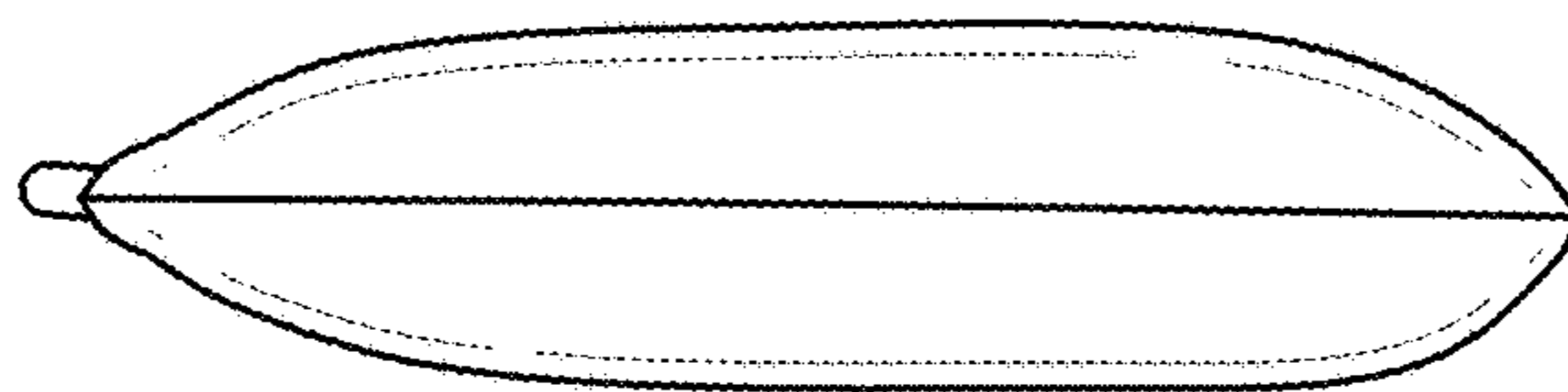
**FIG. 17**



**FIG. 18**



**FIG. 19**



**FIG. 20**