



US00D851908S

(12) **United States Design Patent**
Casha

(10) **Patent No.:** **US D851,908 S**

(45) **Date of Patent:** **** Jun. 25, 2019**

(54) **REUSABLE TOTE BAG WITH ATTACHED FASTENING STRAP**

(71) Applicant: **Debra A. Casha**, Fair Oaks, CA (US)

(72) Inventor: **Debra A. Casha**, Fair Oaks, CA (US)

(**) Term: **15 Years**

(21) Appl. No.: **29/547,781**

(22) Filed: **Dec. 8, 2015**

(51) **LOC (11) Cl.** **03-01**

(52) **U.S. Cl.**
USPC **D3/201**

(58) **Field of Classification Search**
USPC D3/201, 205, 242, 273, 274, 275, 276,
D3/279, 281, 282, 283, 284, 289, 292,
D3/294, 295, 296, 297, 299, 301, 302,
D3/901, 903, 905; D9/414
CPC A45C 5/04; A45C 11/00; A45C 11/16
See application file for complete search history.

(56) **References Cited**

U.S. PATENT DOCUMENTS

D246,940 S *	1/1978	Sabol	D3/246
D590,150 S *	4/2009	Miller	D3/246
D608,089 S *	1/2010	McCoy	D3/232
D631,654 S *	2/2011	Lizhu	D3/233
D641,157 S *	7/2011	Steele	D3/232
D653,849 S *	2/2012	Jariwala	D3/232
D702,435 S *	4/2014	Kriemler	D3/232
D740,022 S *	10/2015	Chadwell	D3/232
D751,288 S *	3/2016	Majmundar	A45C 9/00
				D3/233
D762,378 S *	8/2016	Domotor	D3/233
D784,687 S *	4/2017	Miller	D3/232

* cited by examiner

Primary Examiner — Holly E Thurman

(57) **CLAIM**

I claim the ornamental design for a reusable tote bag with attached fastening strap, as shown and described.

DESCRIPTION

FIG. 1 is a top perspective view of reusable tote bag with attached fastening strap showing my new design;
 FIG. 2 is a front elevation view thereof;
 FIG. 3 is a top plan view thereof;
 FIG. 4 is a rear elevation view thereof;
 FIG. 5 is a bottom plan view thereof;
 FIG. 6 is both a left side and right side elevation view thereof;
 FIG. 7 is a top perspective view of reusable tote bag with attached fastening strap turned inside out showing my new design;
 FIG. 8 is a front elevation view thereof;
 FIG. 9 is a top plan view thereof;
 FIG. 10 is a right side elevation view thereof;
 FIG. 11 is a rear elevation view thereof;
 FIG. 12 is a left side elevation view thereof;
 FIG. 13 is a bottom plan view thereof;
 FIG. 14 is a top perspective view of reusable tote bag with attached fastening strap turned inside out, rolled, and fastened into a cylinder showing my new design;
 FIG. 15 is a right side elevation view thereof;
 FIG. 16 is a left side elevation view thereof;
 FIG. 17 is a top plan view thereof;
 FIG. 18 is a front elevation view thereof;
 FIG. 19 is a bottom elevation view thereof; and,
 FIG. 20 is a rear elevation view thereof.
 The broken lines represent subject matter that forms no part of the claimed design.

1 Claim, 9 Drawing Sheets

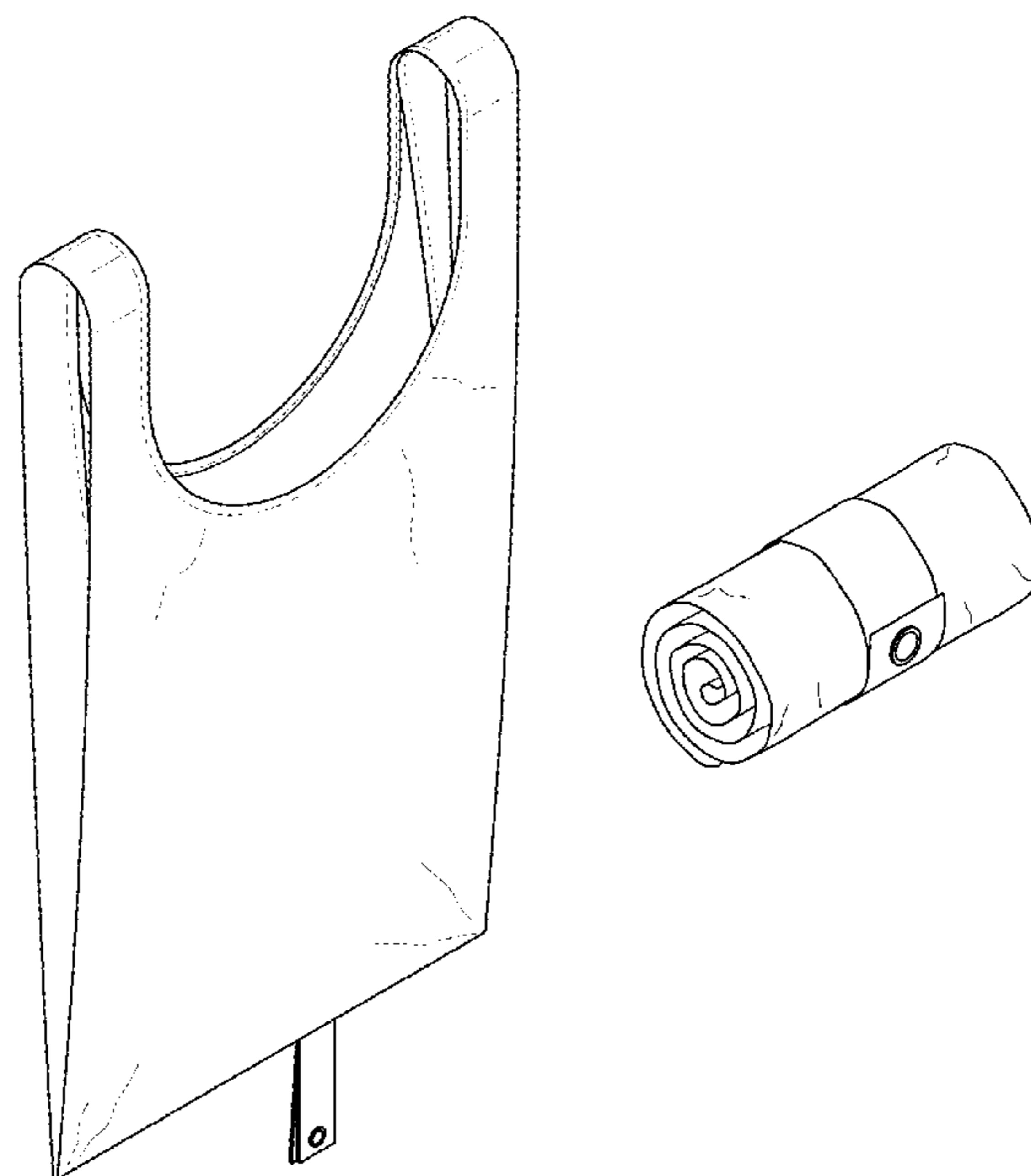

FIG. 1

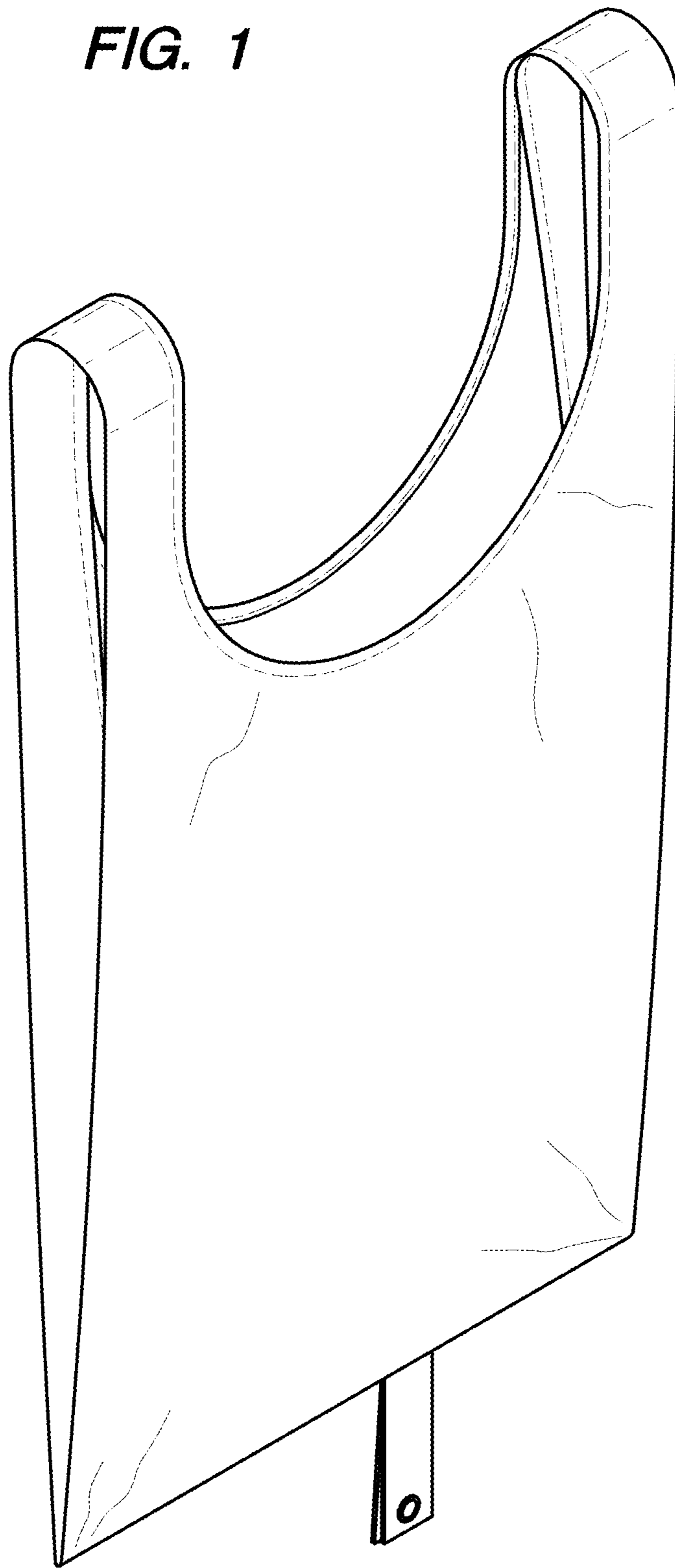

FIG. 2

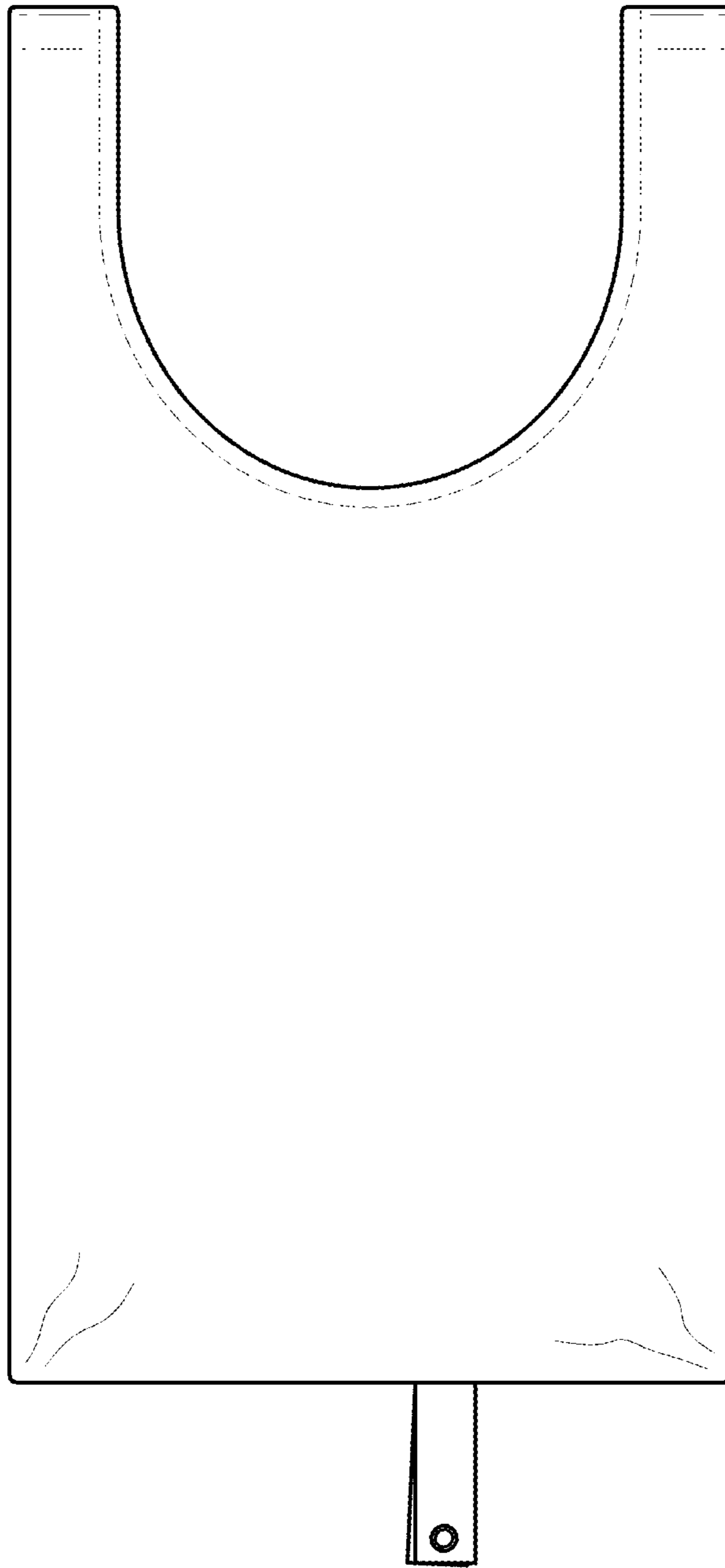

FIG. 3

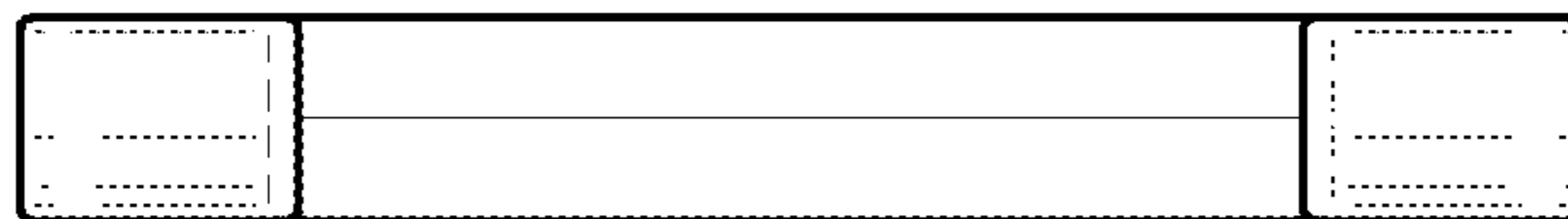

FIG. 4

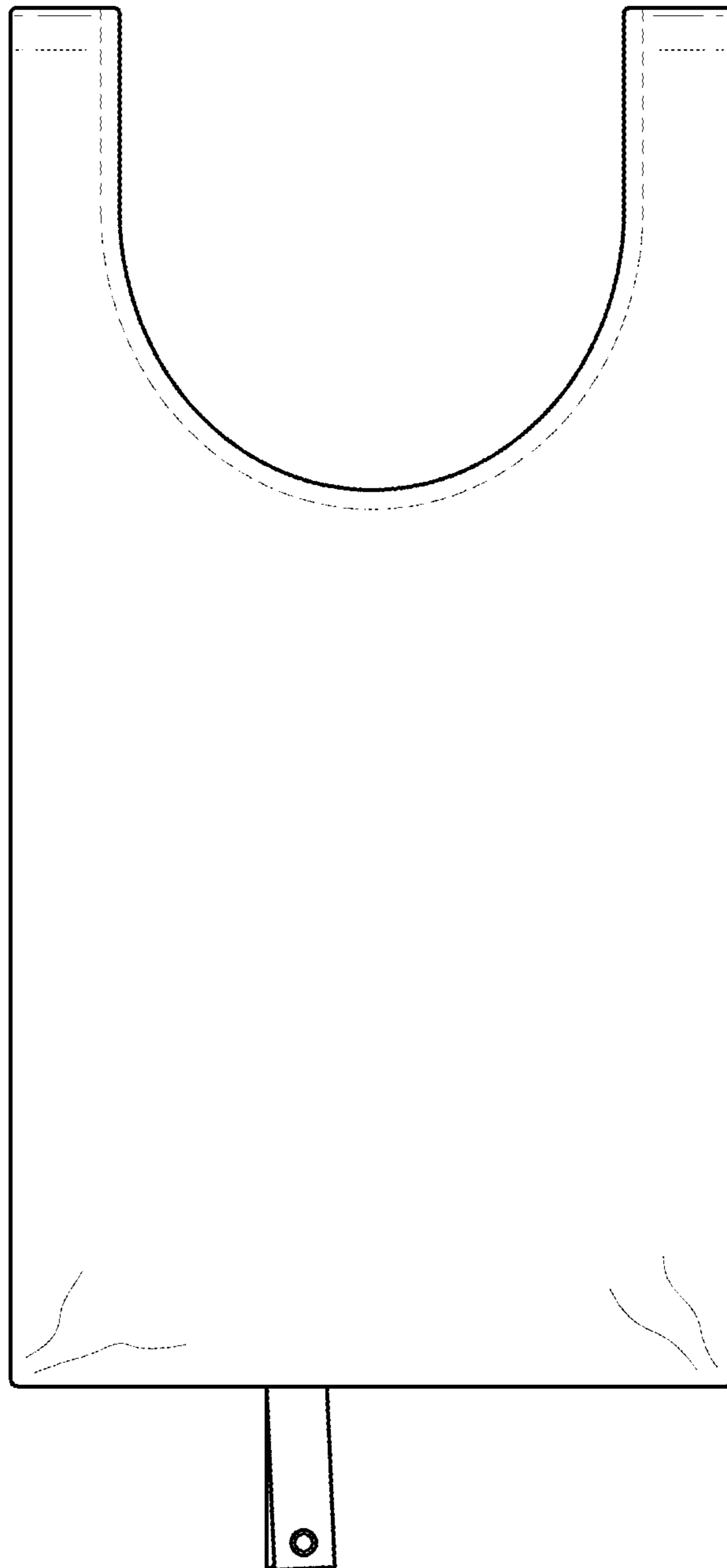

FIG. 5

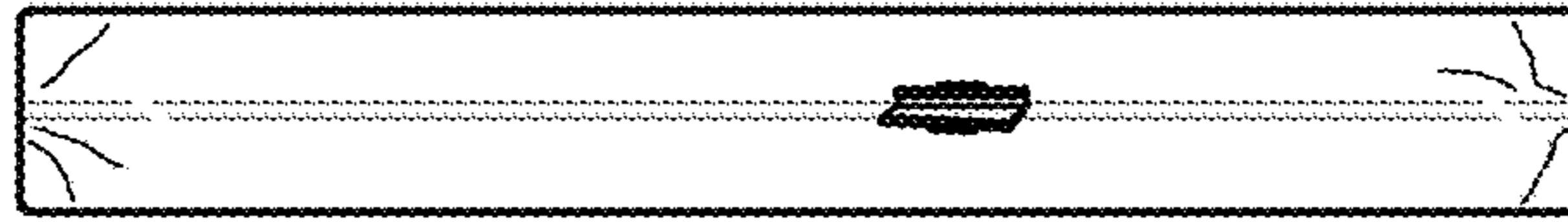

FIG. 6

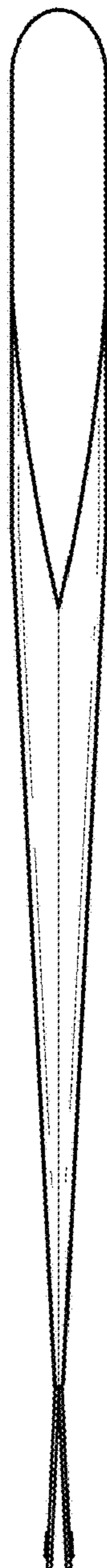

FIG. 7

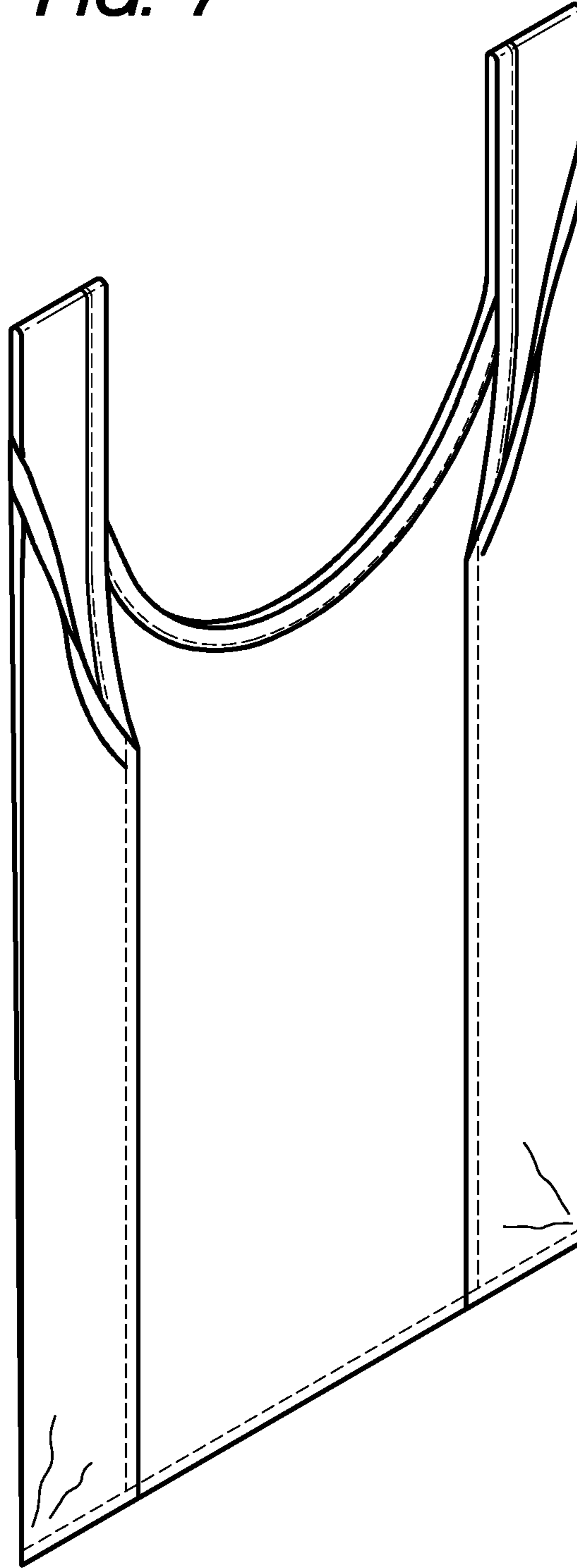

FIG. 8

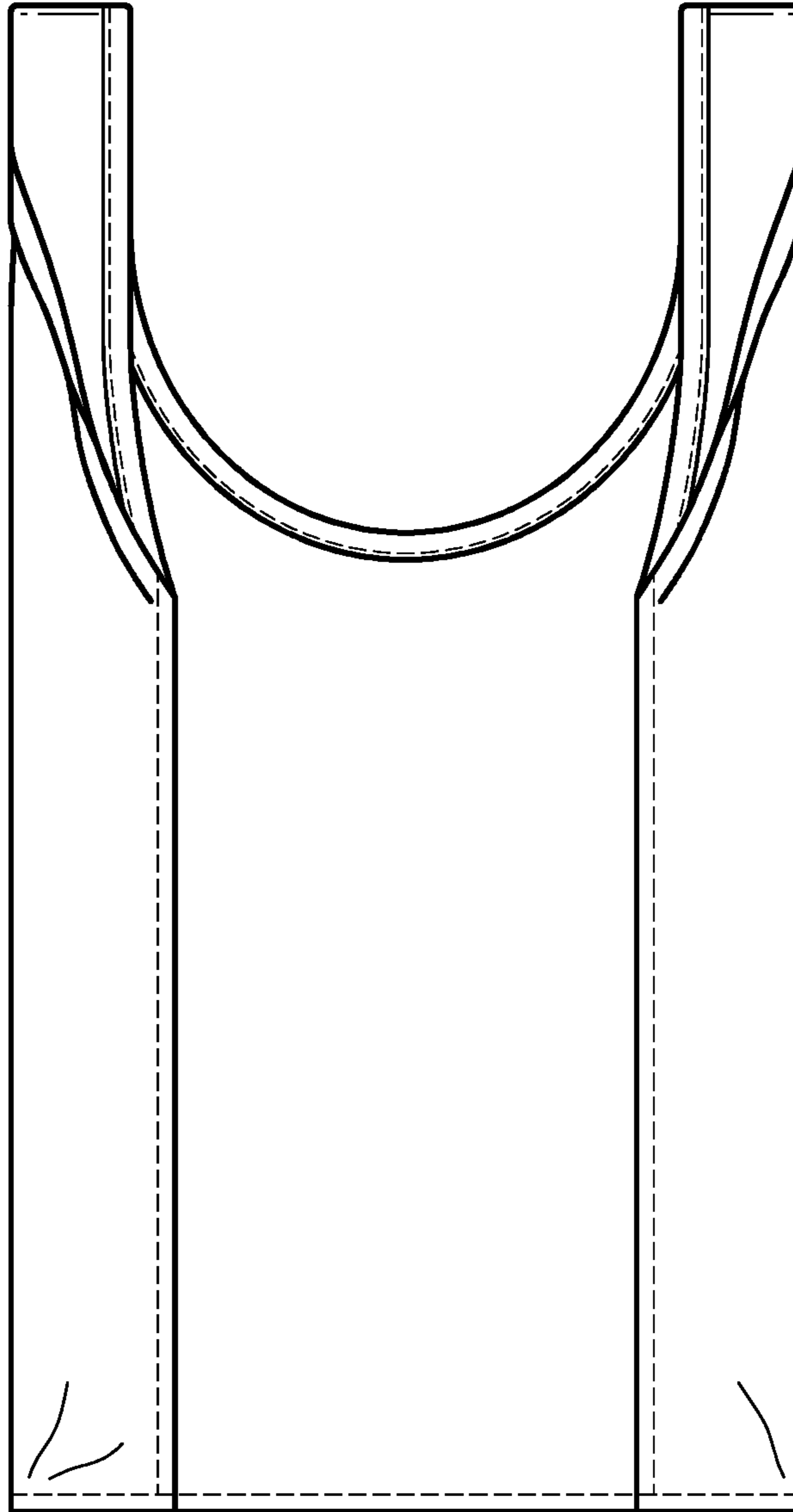

FIG. 9



FIG. 10

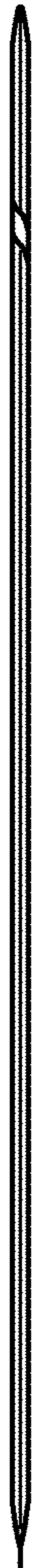

FIG. 11

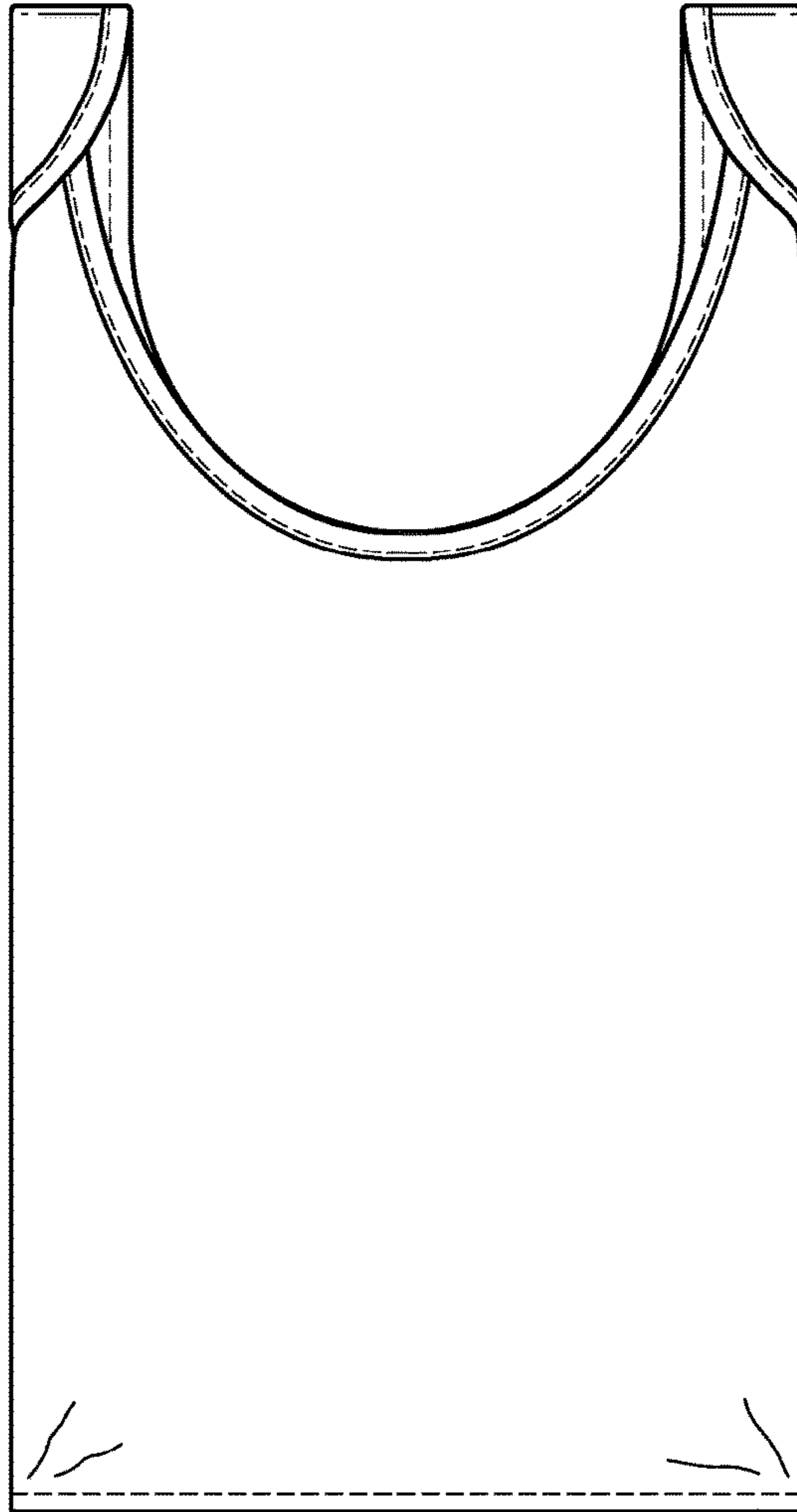

FIG. 12



FIG. 13



FIG. 14

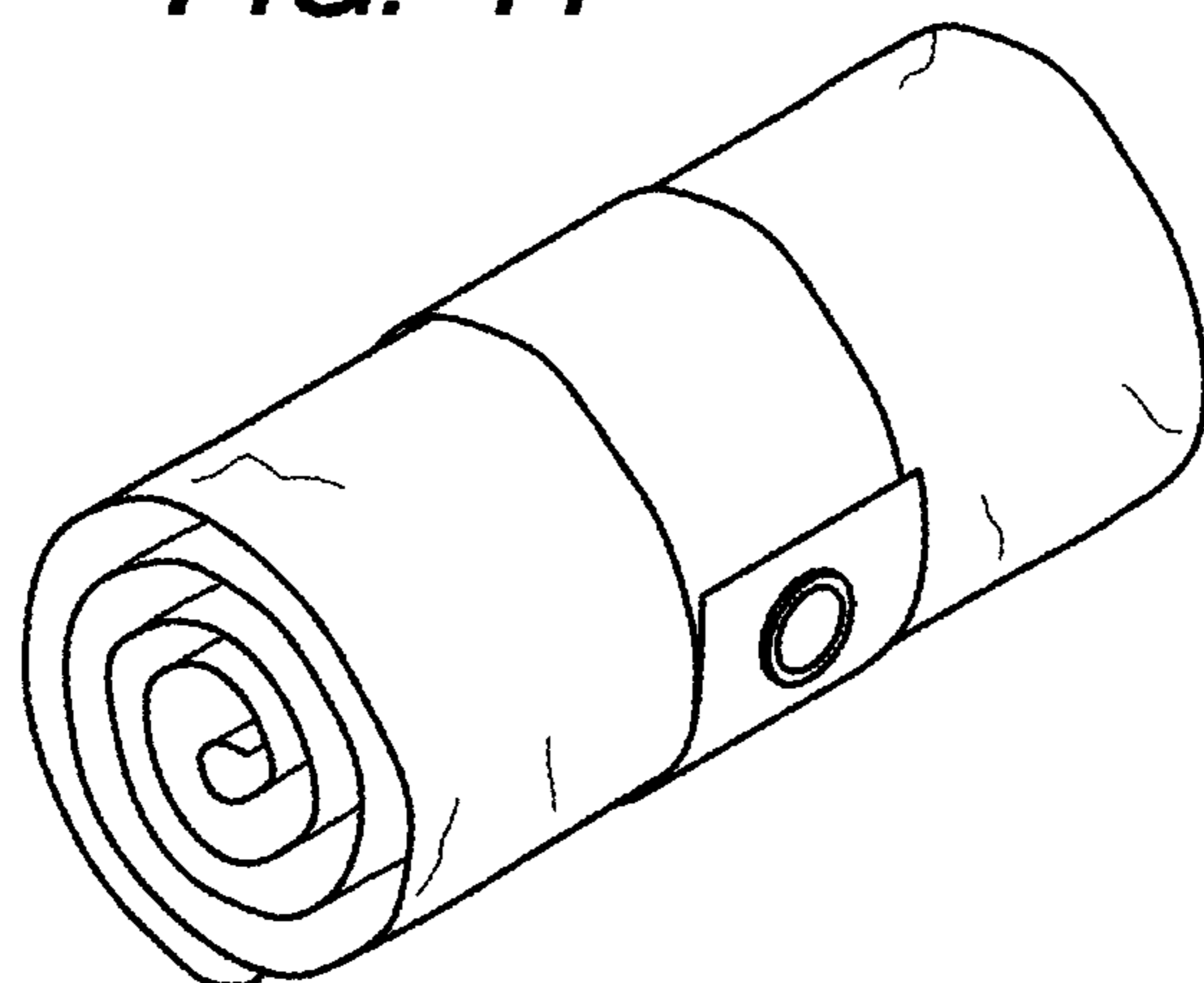

FIG. 15



FIG. 16

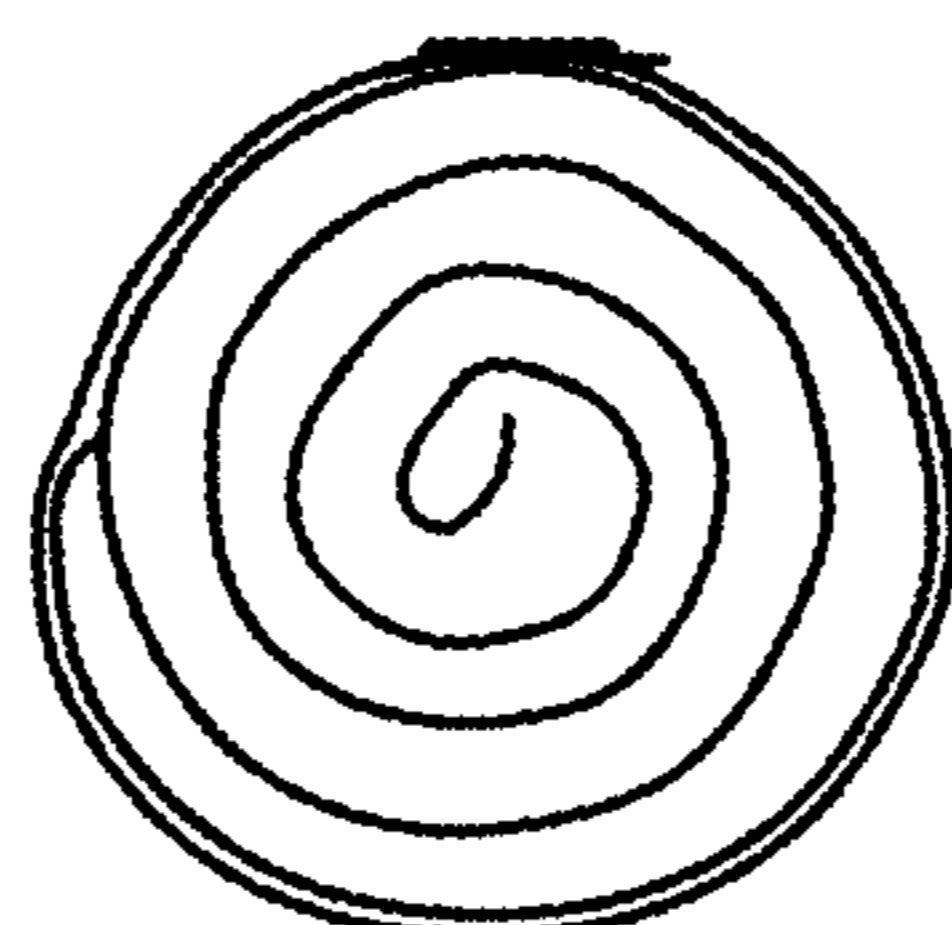

FIG. 17

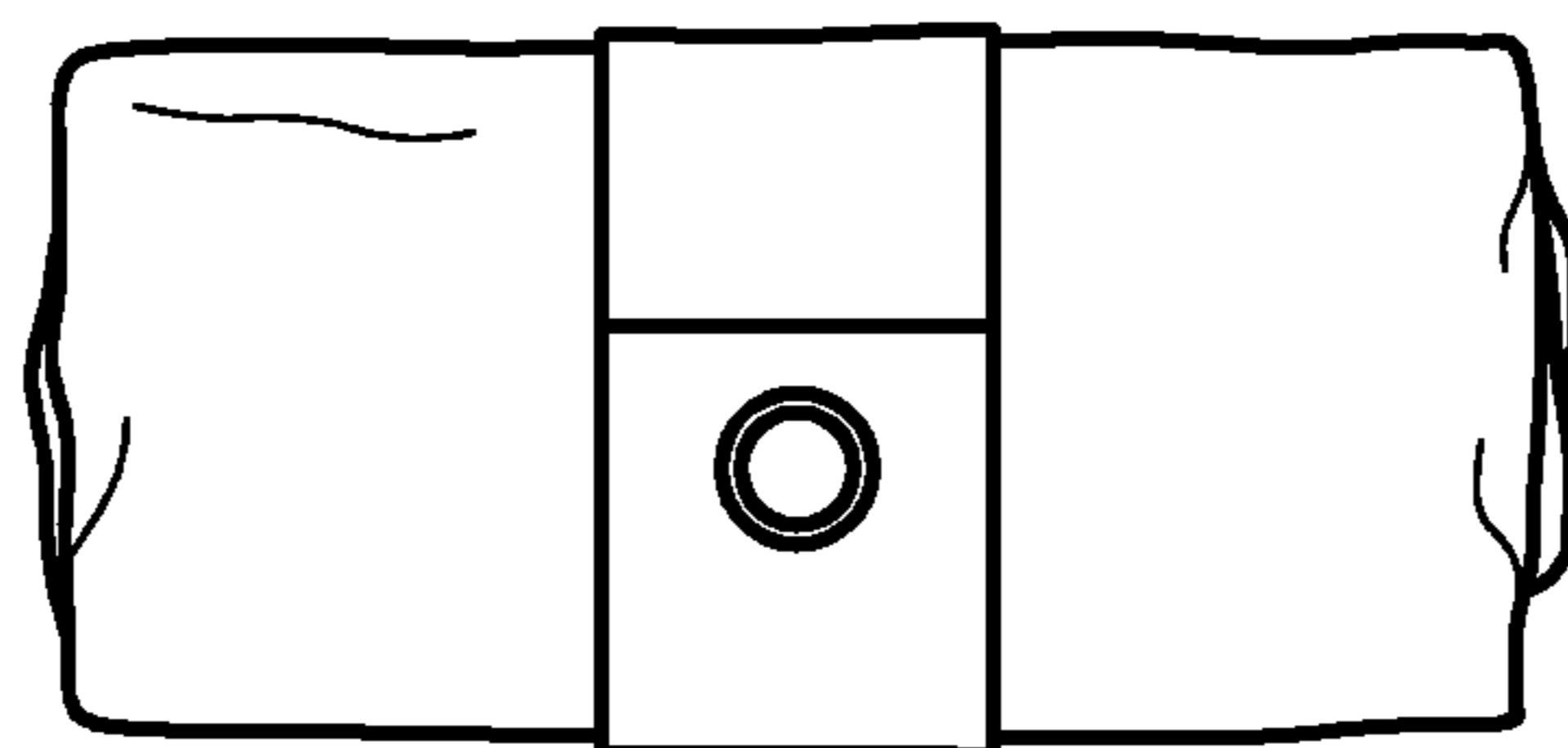

FIG. 18

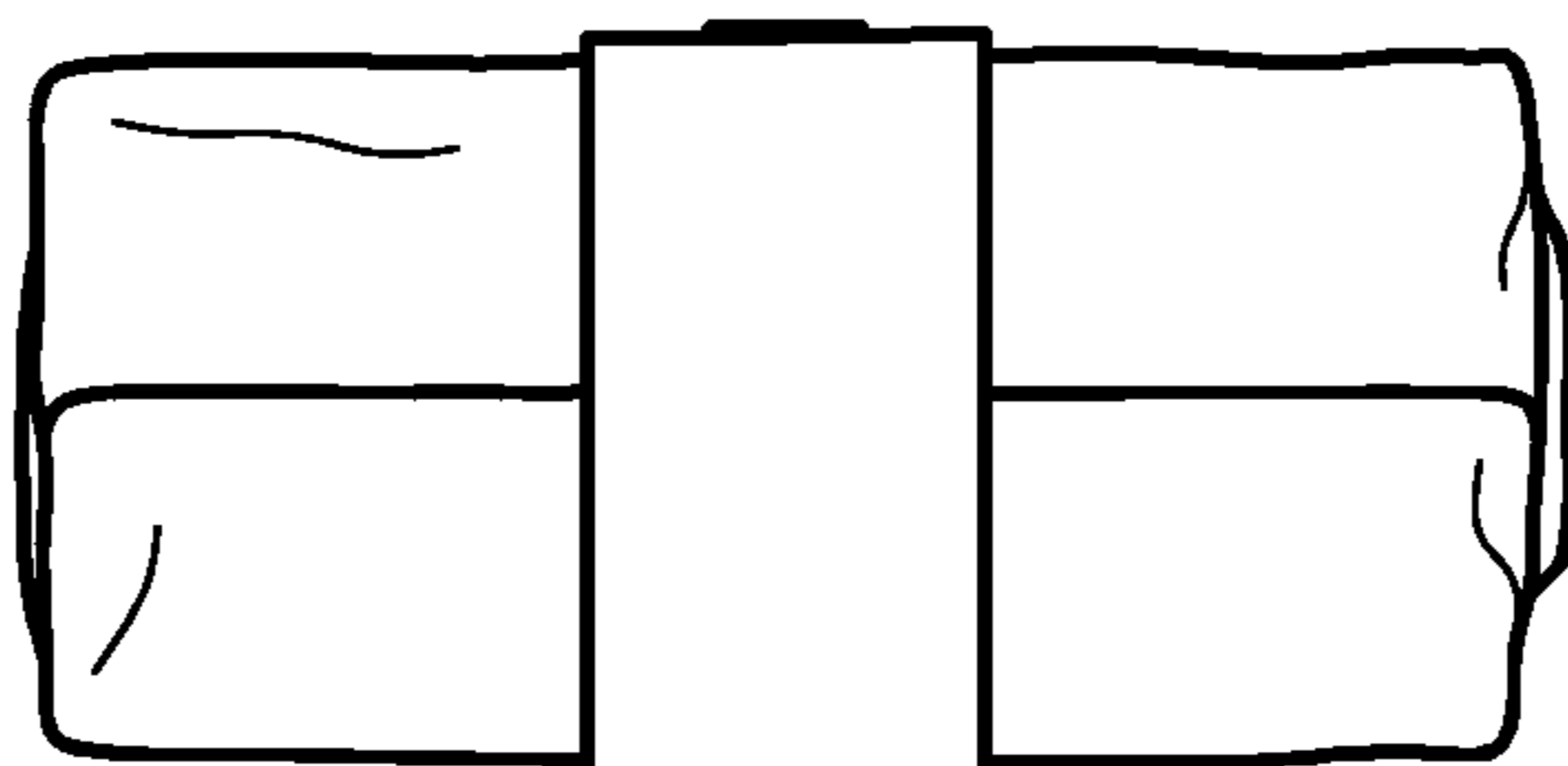

FIG. 19

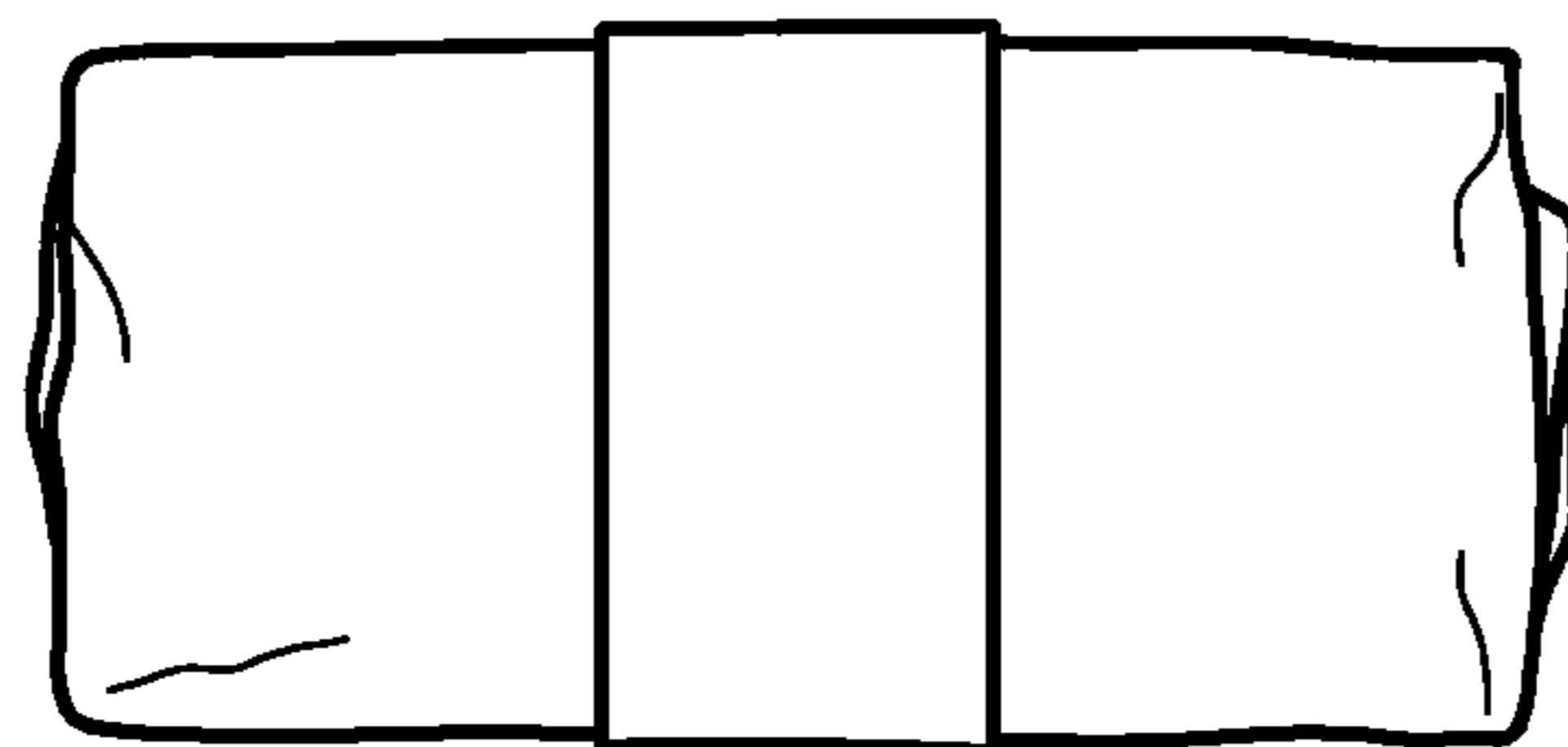

FIG. 20

