

US00D851878S

(12) **United States Design Patent** (10) **Patent No.:** **US D851,878 S**
Pauk (45) **Date of Patent:** **** Jun. 25, 2019**

(54) **SHOE**
(71) Applicant: **NIKE, Inc.**, Beaverton, OR (US)
(72) Inventor: **Matthew R. Pauk**, Portland, OR (US)
(73) Assignee: **NIKE, Inc.**, Beaverton, OR (US)
(**) Term: **15 Years**
(21) Appl. No.: **29/656,081**
(22) Filed: **Jul. 10, 2018**
(51) **LOC (11) Cl.** **02-04**
(52) **U.S. Cl.**
USPC **D2/947**
(58) **Field of Classification Search**
USPC D2/902, 906, 908, 916, 918, 925,
D2/946-962, 977; 36/3 B, 22 R, 24.5,
36/25 R, 28, 32 R, 34 R, 59 C, 67 A, 103
CPC A43B 13/00; A43B 13/02; A43B 13/023;
A43B 13/026; A43B 13/04; A43B 13/08;
A43B 13/10; A43B 13/12; A43B 13/14;
A43B 13/141; A43B 13/143; A43B
13/16; A43B 13/18; A43B 13/181; A43B
13/187; A43B 13/189; A43B 13/20; A43B
13/22; A43B 13/223; A43B 13/24; A43B
13/28; A43B 13/30; A43B 13/32; A43B
13/34; A43B 13/36
See application file for complete search history.

(56) **References Cited**
U.S. PATENT DOCUMENTS
D291,144 S 8/1987 Tong et al.
D291,383 S 8/1987 Campbell et al.
D294,767 S 3/1988 Igoe
D301,935 S 7/1989 Jonah
D321,584 S 11/1991 Mitsui
D329,126 S 9/1992 Hatfield
D334,275 S 3/1993 Miller et al.
D338,995 S 9/1993 Snell

D345,450 S 3/1994 Kusuki et al.
D350,013 S 8/1994 Gitelman
D358,929 S 6/1995 Peterson
D369,018 S 4/1996 Brooks et al.
D369,019 S 4/1996 Brooks et al.
D399,340 S 10/1998 James
D404,896 S 2/1999 Cooper
D407,540 S 4/1999 Dolinsky
D466,276 S 12/2002 Tomczak
D492,096 S 6/2004 Sanchez et al.
D503,526 S 4/2005 Matis et al.
D511,886 S 11/2005 Galway
D513,666 S 1/2006 Bertholon
D520,726 S 5/2006 Duclos
D577,892 S 10/2008 St-Louis et al.
D636,568 S 4/2011 McMillan
D636,569 S 4/2011 McMillan
(Continued)

OTHER PUBLICATIONS

Nike Footwear Catalog, 1987 Fall Footwear, p. 4, published Jan. 1987, NIKE, Inc., USA.
(Continued)

Primary Examiner — T Chase Nelson
(74) *Attorney, Agent, or Firm* — Banner & Witcoff, Ltd.

(57) **CLAIM**
The ornamental design for a shoe, as shown and described.

DESCRIPTION

FIG. 1 is a front perspective view of a shoe showing my new design;
FIG. 2 is a side view thereof;
FIG. 3 is a rear perspective view thereof;
FIG. 4 is a rear view thereof; and,
FIG. 5 is an opposite side view thereof.
The broken lines depicting the remainder of the shoe show features that form no part of the claimed design.

1 Claim, 5 Drawing Sheets

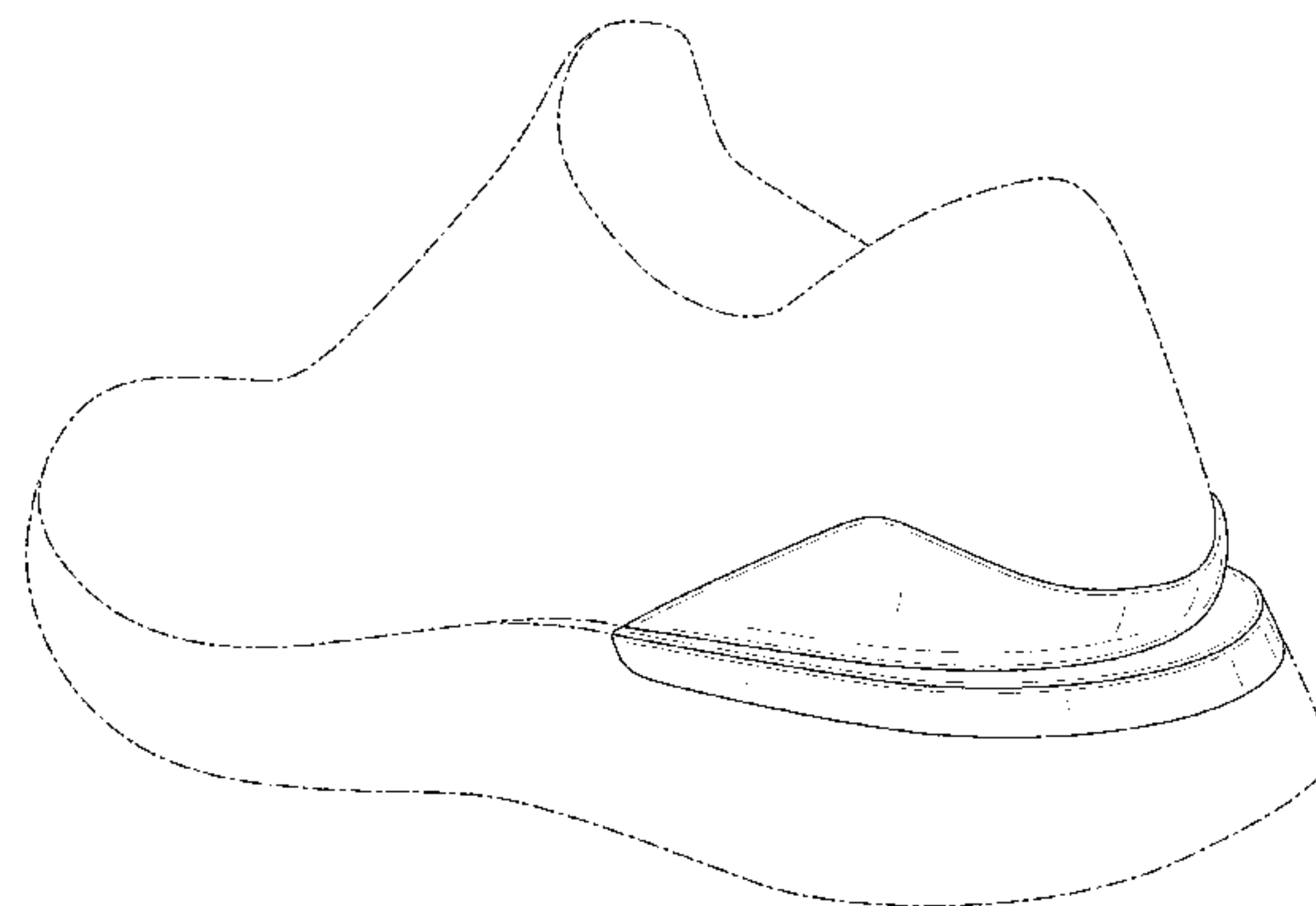
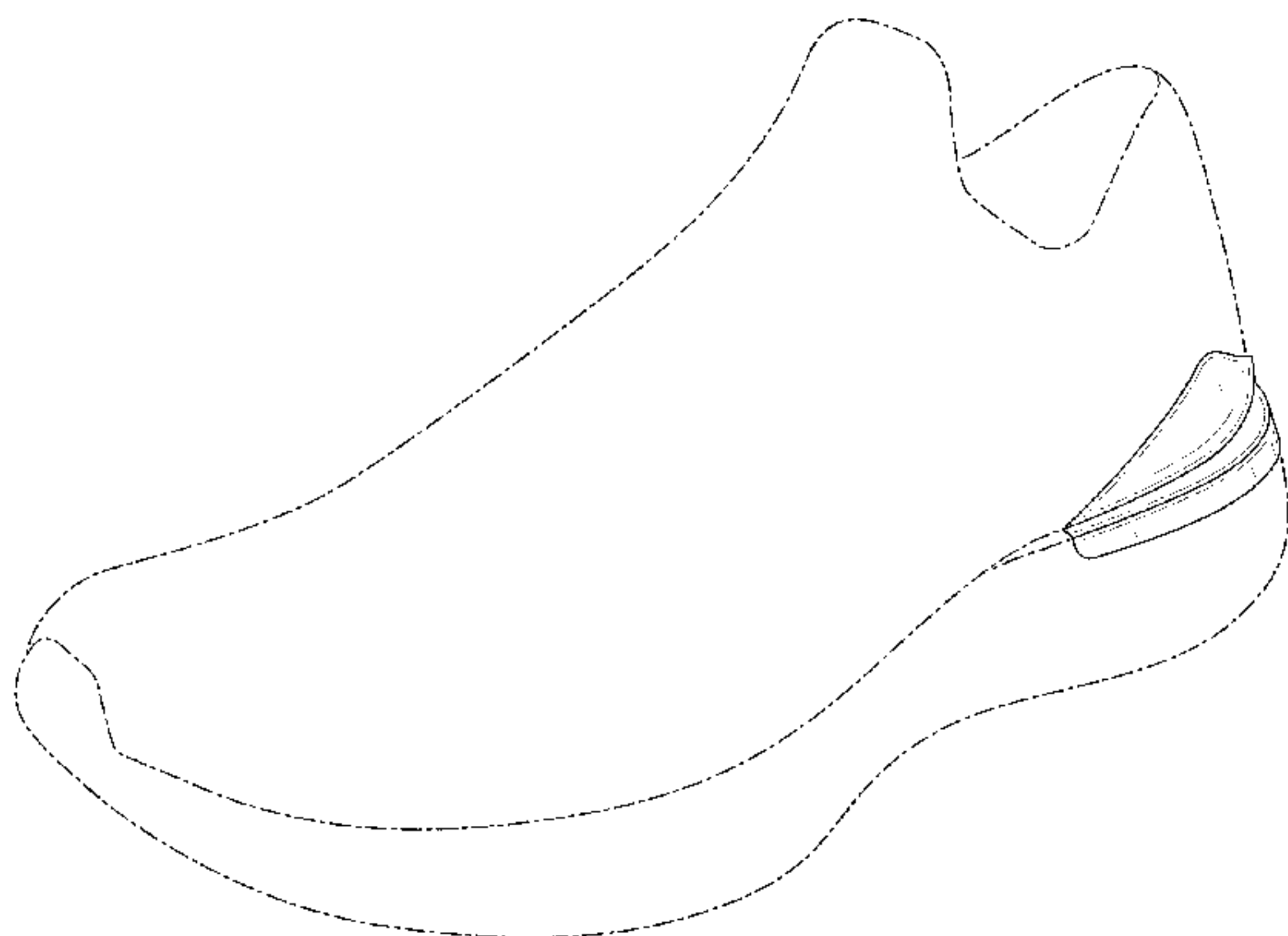

(56)

References Cited

U.S. PATENT DOCUMENTS

D658,859	S	5/2012	Nakamura	
D661,878	S	6/2012	Grenet	
D701,036	S	3/2014	Martin	
D723,772	S	3/2015	Miner	
D723,778	S	3/2015	Miner	
D723,782	S	3/2015	Miner	
D723,784	S	3/2015	Miner	
D725,356	S	3/2015	Miner	
D725,359	S	3/2015	Miner	
D752,321	S *	3/2016	Sirius-El	D2/908
D771,367	S	11/2016	Taylor	
D778,553	S *	2/2017	DeAlmeida	D2/947
D778,565	S *	2/2017	Sars	D2/960
D789,047	S	6/2017	Bruder et al.	
D789,052	S	6/2017	Hardman	
D792,065	S	7/2017	Shyllon	
D793,701	S	8/2017	Parker	
D794,287	S	8/2017	Raasch	
D801,672	S	11/2017	Small	
D802,266	S *	11/2017	Hardman	D2/947
D803,531	S *	11/2017	Petrie	D2/947
D807,632	S	1/2018	Sullivan	
D808,132	S *	1/2018	Sars	D2/906
D808,629	S	1/2018	Parrett et al.	
D810,407	S *	2/2018	DeAlmeida	D2/947
D813,506	S *	3/2018	O'Connor	D2/947
D814,779	S	4/2018	Goto	
D816,972	S	5/2018	Pauk	
D816,973	S	5/2018	Pauk	
D817,611	S	5/2018	Small	
D817,612	S	5/2018	Small	
D817,628	S	5/2018	Hatfield	
D819,311	S	6/2018	Jury et al.	
D821,734	S *	7/2018	Petrie	D2/977
D822,349	S	7/2018	Petrenka	
D822,353	S	7/2018	Donadei	
D822,965	S *	7/2018	DeAlmeida	D2/947
D829,423	S	10/2018	Robusti	
D835,389	S *	12/2018	Durflinger	D2/947
D838,966	S *	1/2019	Pauk	D2/972
D841,297	S *	2/2019	Small	D2/947
D841,298	S *	2/2019	Small	D2/947

OTHER PUBLICATIONS

Nike Footwear Catalog, 1988 Spring Footwear, p. 4, published Jun. 1987, NIKE, Inc., USA.
 Nike Footwear Catalog, 1988 Spring Footwear, p. 40, published Jun. 1987, NIKE, Inc., USA.
 Nike Footwear Catalog, 1988 Fall Footwear, p. 6, published Dec. 1987, NIKE, Inc., USA.
 Nike Footwear Catalog, 1988 Fall Footwear, p. 8, published Dec. 1987, NIKE, Inc., USA.

Nike Footwear Catalog, 1988 Fall Footwear, p. 98, published Dec. 1987, NIKE, Inc., USA.
 Nike Footwear Catalog, 1989 Spring Footwear, p. 104, published Jun. 1988, NIKE, Inc., USA.
 Nike Footwear Catalog, 1989 Spring Footwear, p. 132, published Jun. 1988, NIKE, Inc., USA.
 Nike Footwear Catalog, 1989 Fall Footwear, p. 70, published Dec. 1988, NIKE, Inc., USA.
 Nike Footwear Catalog, 1989 Fall Footwear, p. 90, published Dec. 1988, NIKE, Inc., USA.
 Nike Footwear Catalog, 1990 Spring Footwear, p. 108, published Jun. 1989, NIKE, Inc., USA.
 Nike Footwear Catalog, 1991 Spring Footwear, p. 7, published Jun. 1990, NIKE, Inc., USA.
 Nike Footwear Catalog, 1991 Spring Footwear, p. 108, published Jun. 1990, NIKE, Inc., USA.
 Nike Footwear Catalog, 1991 Spring Footwear, p. 140, published Jun. 1990, NIKE, Inc., USA.
 Nike Footwear Catalog, 2009 Spring Sport Performance Footwear, p. 57, published May 2008, NIKE, Inc., USA.
 Nike Footwear Catalog, 2011 Spring Men's Tennis Footwear, p. 78, published May 2010, NIKE, Inc., USA.
 Nike Footwear Catalog, 2011 Fall Men's Performance Footwear, p. 44, published Nov. 2010, NIKE, Inc., USA.
 Nike Footwear Catalog, 2016 Spring Dept Store Footwear Best NA, p. 69, published May 2015, NIKE, Inc., USA.
 Nike Epic React Coming Soon in White and Pink 2 [online], retrieved Nov. 20, 2018], retrieved from Sneaker News [Internet] <URL: <https://sneakernews.com/2018/04/25/nike-epic-react-white-pink-release-info/>>; 5 color pages, Dated Apr. 25, 2018.
 Nike Footwear Catalog, 2018 Holiday Running, p. 104, published date unknown, but prior to the filing date of the present application, NIKE, Inc., USA.
 Nike Footwear Catalog, 2019 Spring Running, p. 105, published date unknown, but prior to the filing date of the present application, NIKE, Inc., USA.
 Rebel React Sneaker [online], retrieved Nov. 20, 2018], retrieved from Nordstrom [Internet] <URL: <https://shop.nordstrom.com/s/nike-rebel-react-sneaker-men/4871742>>>; 4 color pages, Published date unknown, but prior to the filing date of the present application.
 Men's Running Shoe Nike Renew Rival [online], retrieved Nov. 20, 2018], retrieved from NIKE [Internet] <URL: <https://www.nike.com/t/renew-rival-mens-running-shoe-dvoR0P/AA7400-401>>; 5 color pages, Published date unknown, but prior to the filing date of the present application.
 Nike Glide React Running [online], retrieved Nov. 20, 2018], retrieved from Sun Sand and Sports [Internet] <URL: <https://sssports.com/nike-glide-react-running-shoe-nikeao9820-001>>; 4 color sheets, Published date unknown, but prior to the filing date of the present application.

* cited by examiner

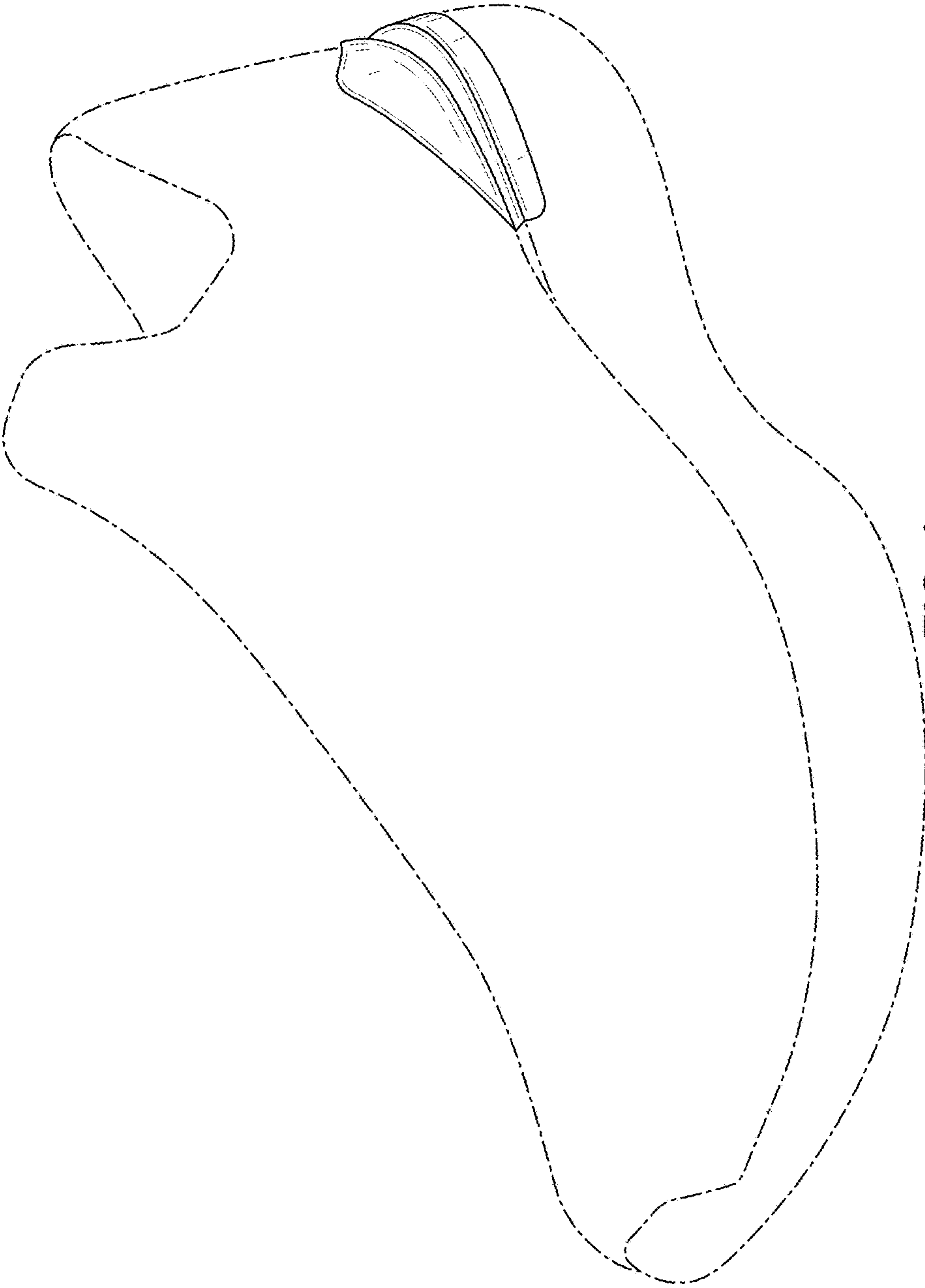

FIG. 1

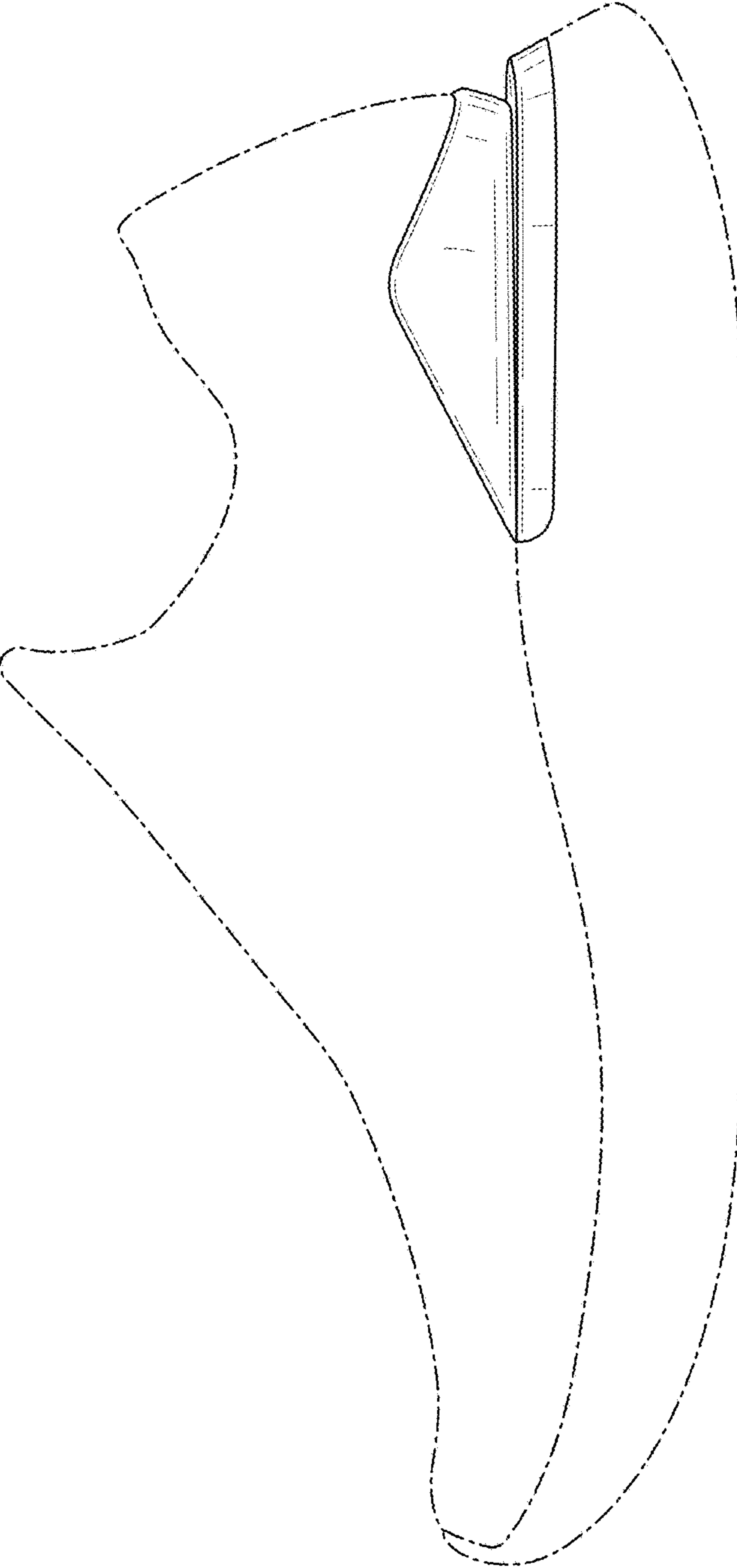

FIG. 2

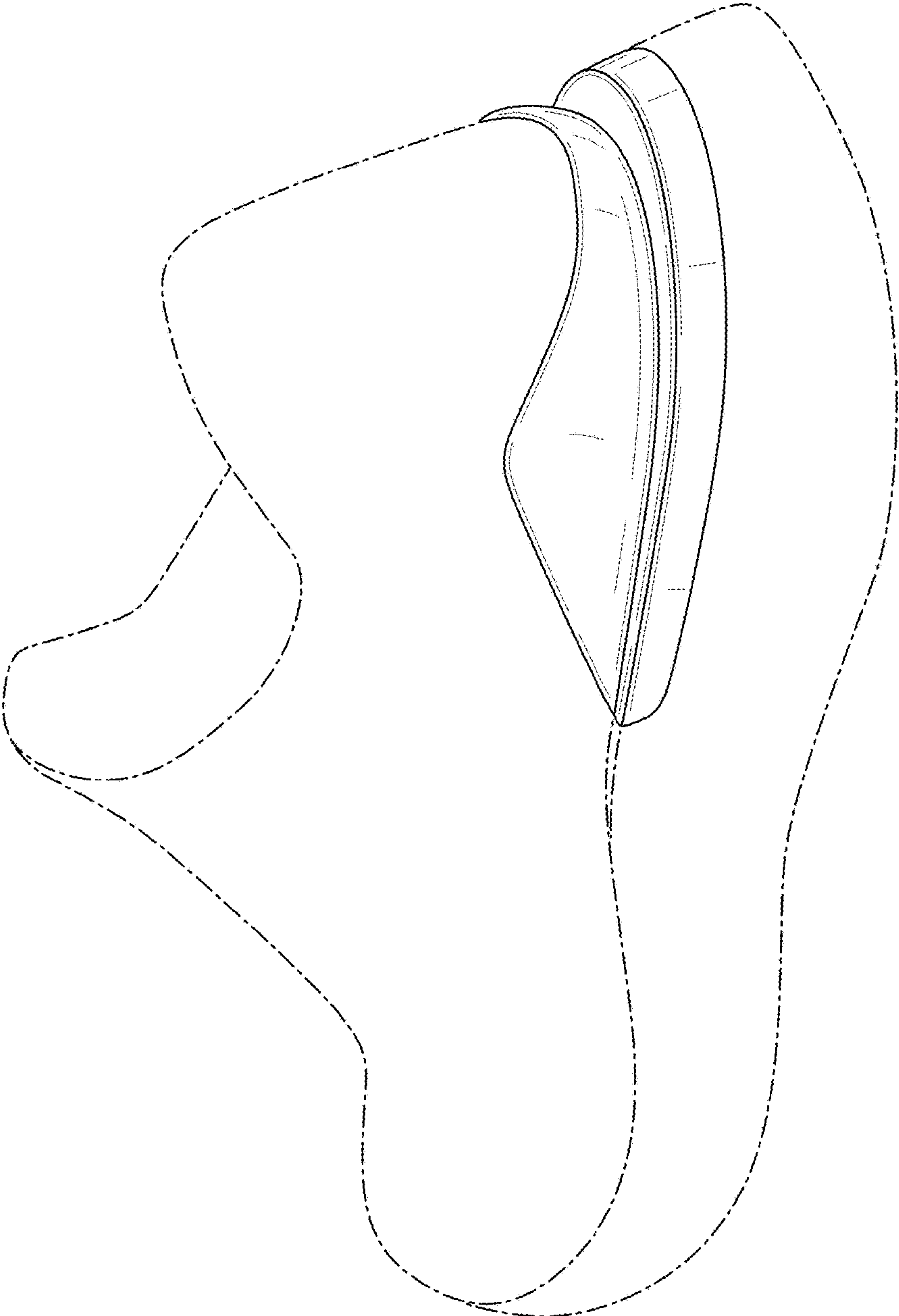

FIG. 3

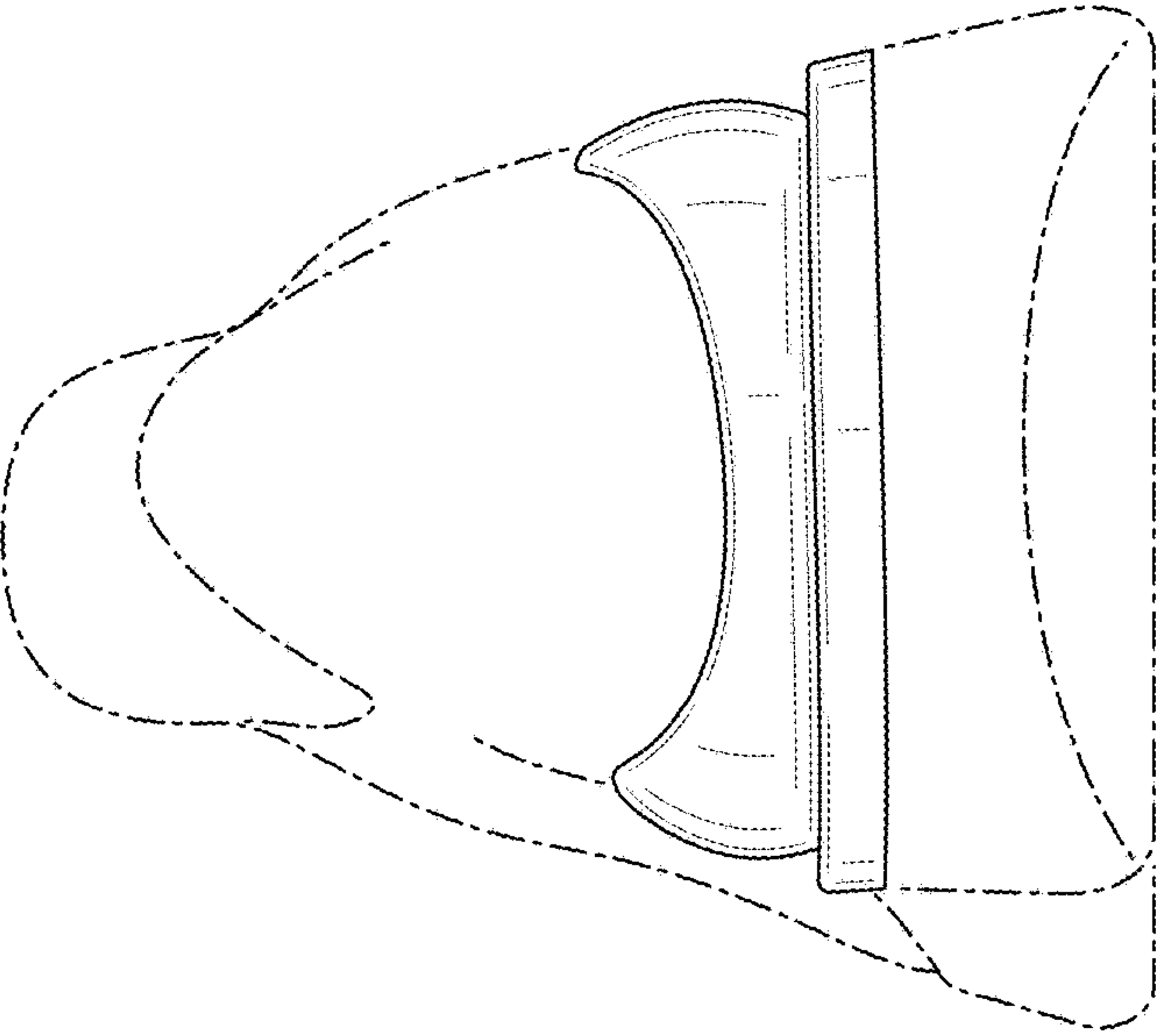

FIG. 4

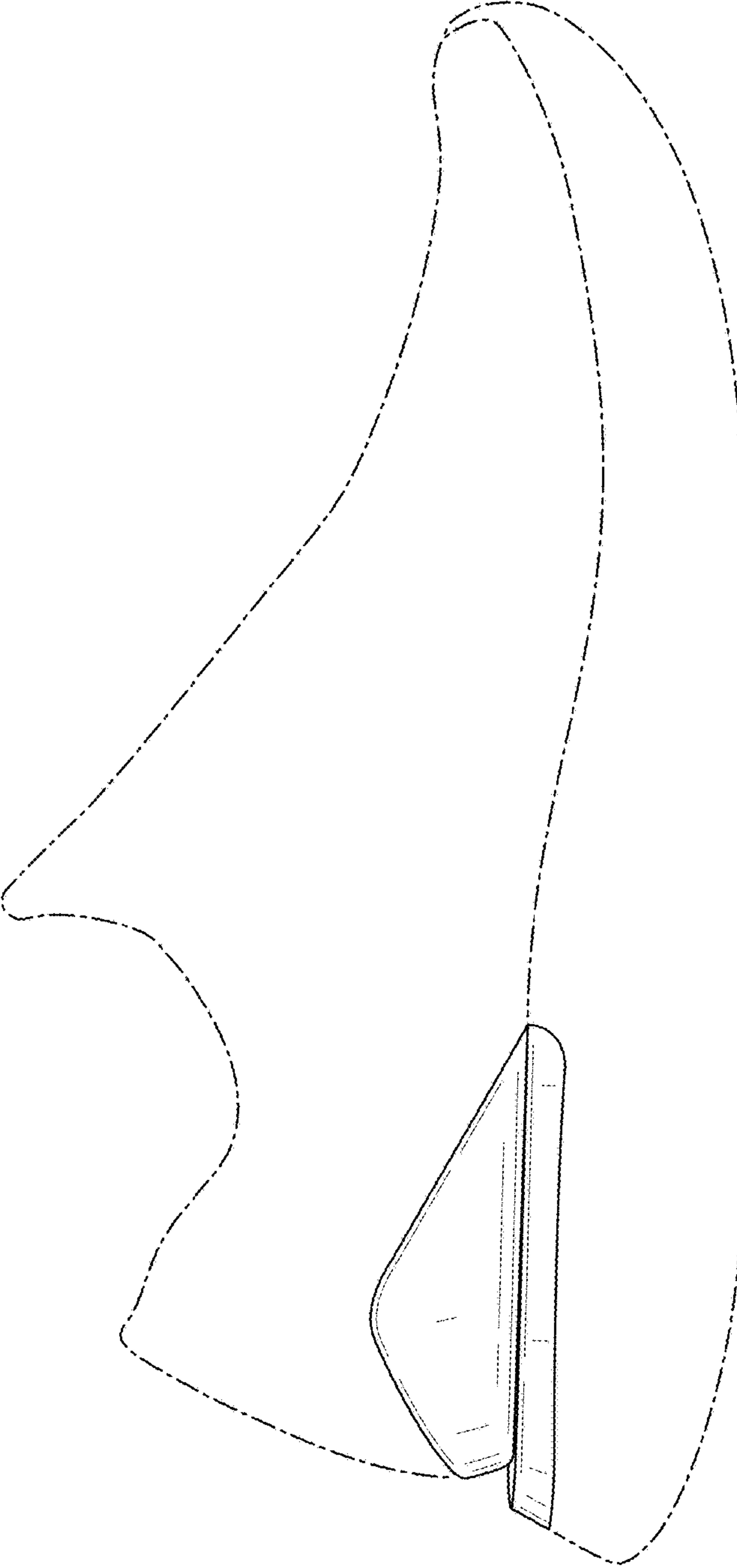

FIG. 5