



US00D851767S

(12) **United States Design Patent** (10) **Patent No.:** **US D851,767 S**  
**Allum et al.** (45) **Date of Patent:** **\*\* Jun. 18, 2019**

(54) **HANDHELD VENTILATOR**  
(71) Applicant: **SILVERBOW DEVELOPMENT, LLC**, San Ramon, CA (US)  
(72) Inventors: **Todd Allum**, Livermore, CA (US); **Gregory J. Kapust**, San Ramon, CA (US); **Jose J. Aguirre, Jr.**, San Ramon, CA (US)  
(73) Assignee: **SILVERBOW DEVELOPMENT, LLC**, San Ramon, CA (US)

(\*\*) Term: **15 Years**  
(21) Appl. No.: **29/602,719**

(22) Filed: **May 2, 2017**  
(51) **LOC (11) Cl.** ..... **24-02**  
(52) **U.S. Cl.**  
USPC ..... **D24/164**  
(58) **Field of Classification Search**  
USPC ..... D24/164, 186, 168, 146, 110, 138, 107, D24/167; 62/48.1  
CPC ..... A63B 21/0085; A61M 16/14  
See application file for complete search history.

(56) **References Cited**  
U.S. PATENT DOCUMENTS  
D531,725 S \* 11/2006 Loerwald ..... D24/146  
D544,605 S \* 6/2007 Gumisawa ..... D24/186  
D696,394 S \* 12/2013 Lu ..... D24/110  
D702,355 S \* 4/2014 Laplante ..... D24/186  
D741,492 S \* 10/2015 Formica ..... D24/164  
D741,497 S \* 10/2015 Aber ..... D24/167  
D769,438 S \* 10/2016 Crosby ..... D24/110

D776,284 S \* 1/2017 Ratto ..... D24/186  
D777,902 S \* 1/2017 Souney ..... D24/107  
D781,249 S \* 3/2017 Park ..... D13/168  
D787,463 S \* 5/2017 Maxwell ..... D14/130  
D789,545 S \* 6/2017 Pippel ..... D24/186  
D794,807 S \* 8/2017 Kranz ..... D24/186  
D797,936 S \* 9/2017 Higashiyama ..... D24/164  
D801,525 S \* 10/2017 Ohno ..... D24/138  
D802,132 S \* 11/2017 Ohno ..... D24/138  
D811,596 S \* 2/2018 Verbrugge ..... D24/164  
D819,811 S \* 6/2018 Ohno ..... D24/138  
D820,446 S \* 6/2018 Ohno ..... D24/138

\* cited by examiner

*Primary Examiner* — Rhea Shields  
(74) *Attorney, Agent, or Firm* — Artegis Law Group, LLP

(57) **CLAIM**

The ornamental design for a handheld ventilator, as shown and described.

**DESCRIPTION**

FIG. 1 is a left isometric view of a handheld ventilator, showing our new design;  
FIG. 2 is a right isometric view thereof;  
FIG. 3 is a left side view thereof;  
FIG. 4 is a right side view thereof;  
FIG. 5 is a top view thereof;  
FIG. 6 is a bottom view thereof;  
FIG. 7 is back view thereof; and,  
FIG. 8 is front view thereof.  
The broken lines in the figures are for purposes of illustrating environment only and form no part of the claimed design.

**1 Claim, 8 Drawing Sheets**

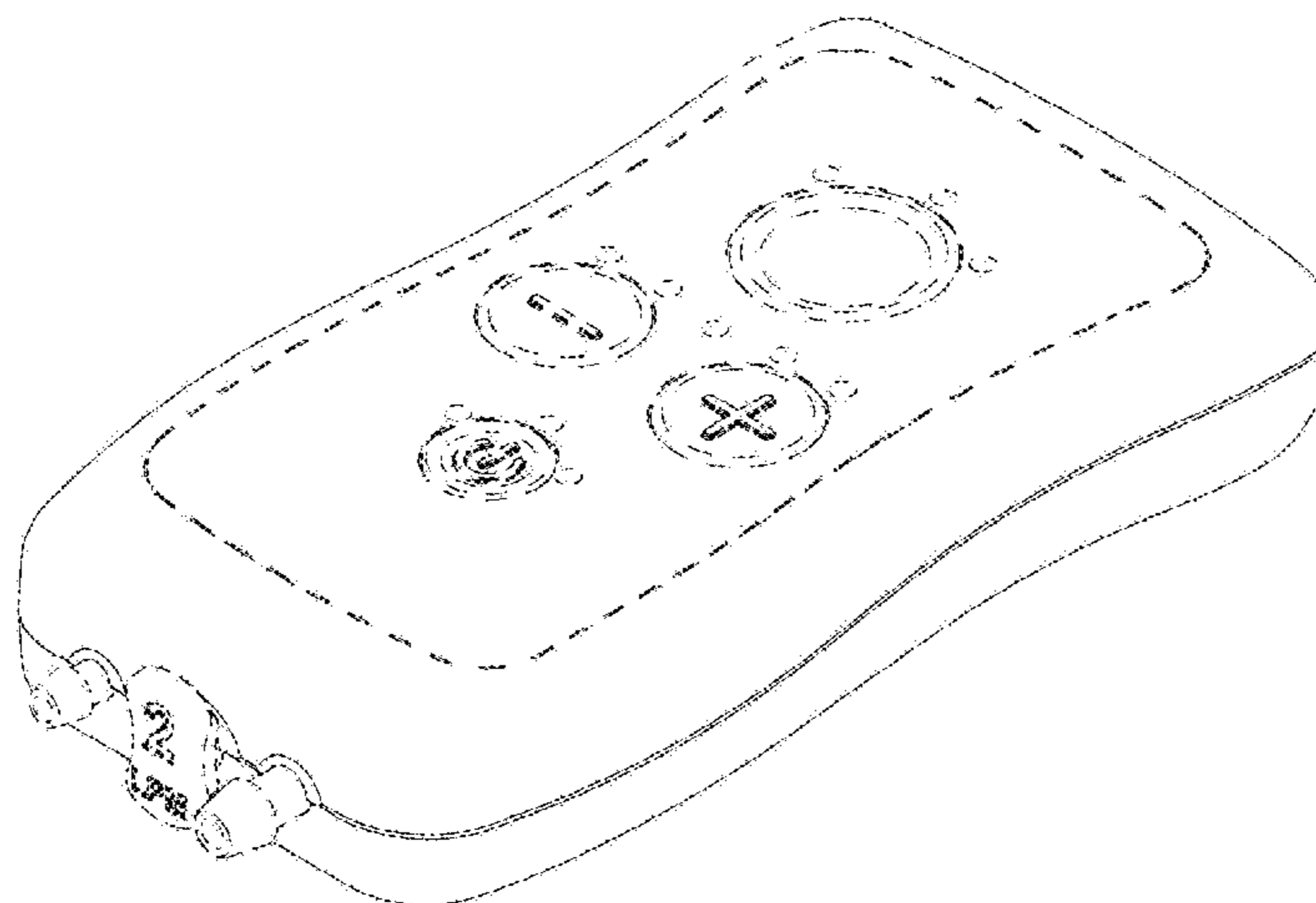

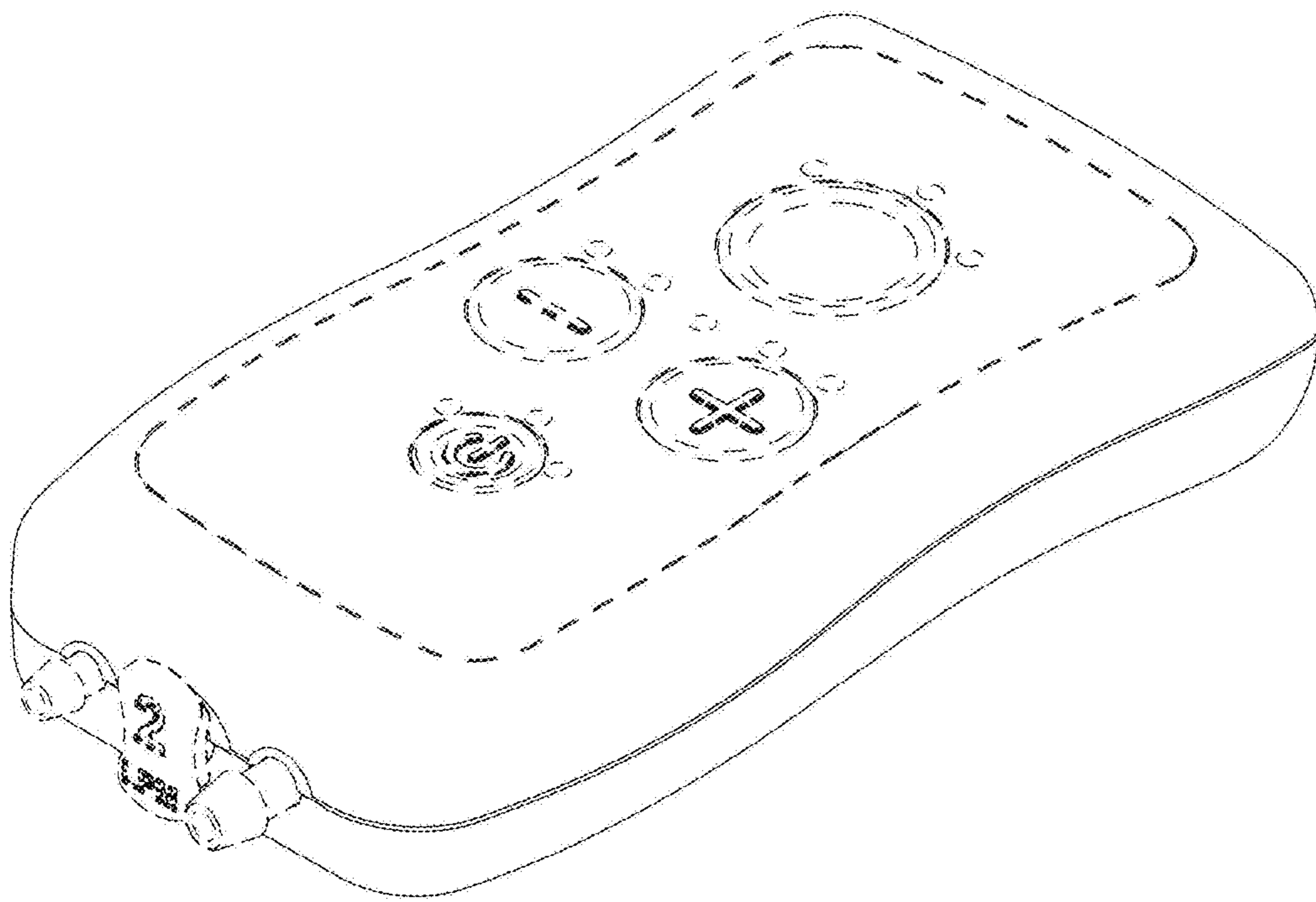

FIG. 1

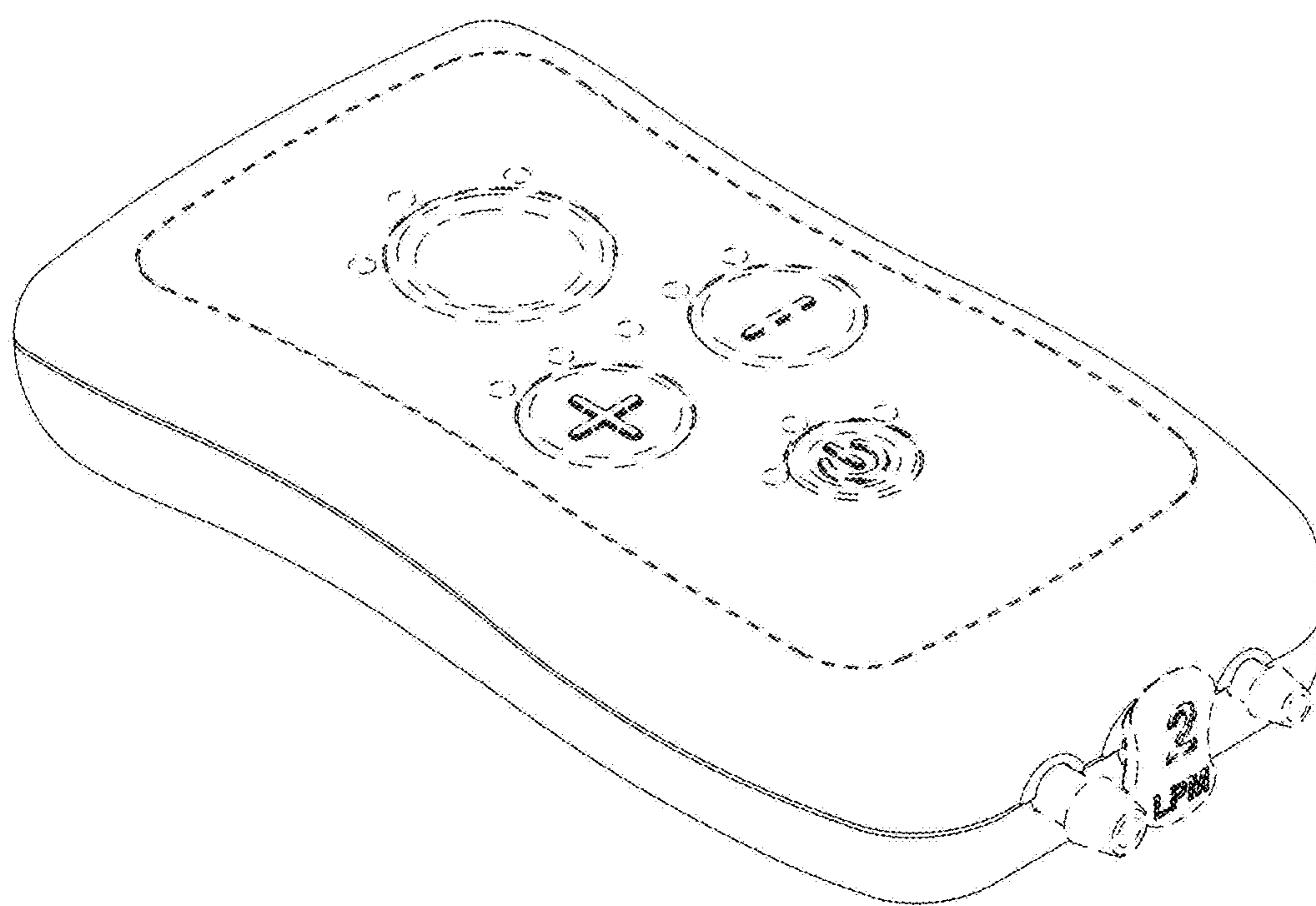

FIG. 2

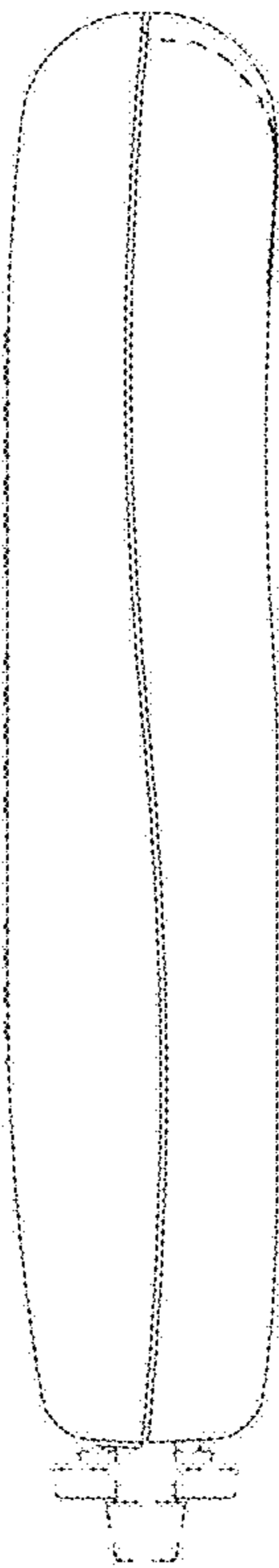

FIG. 3

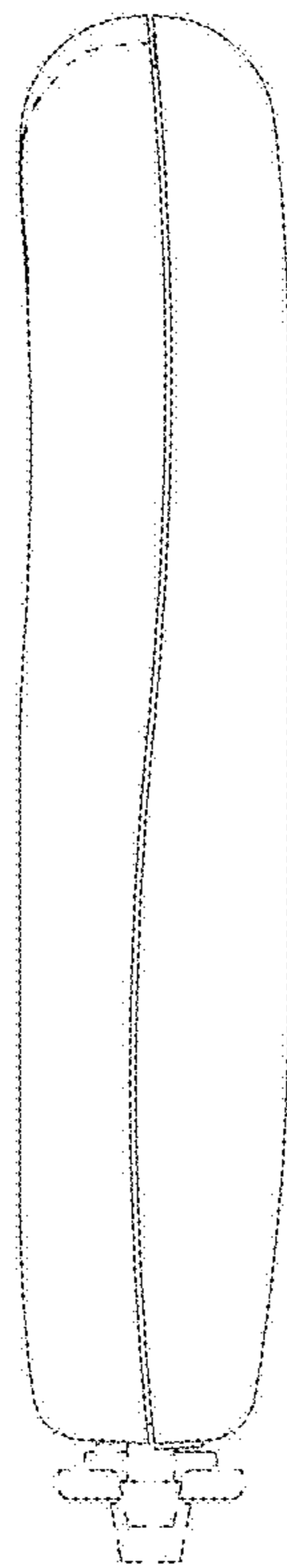

FIG. 4

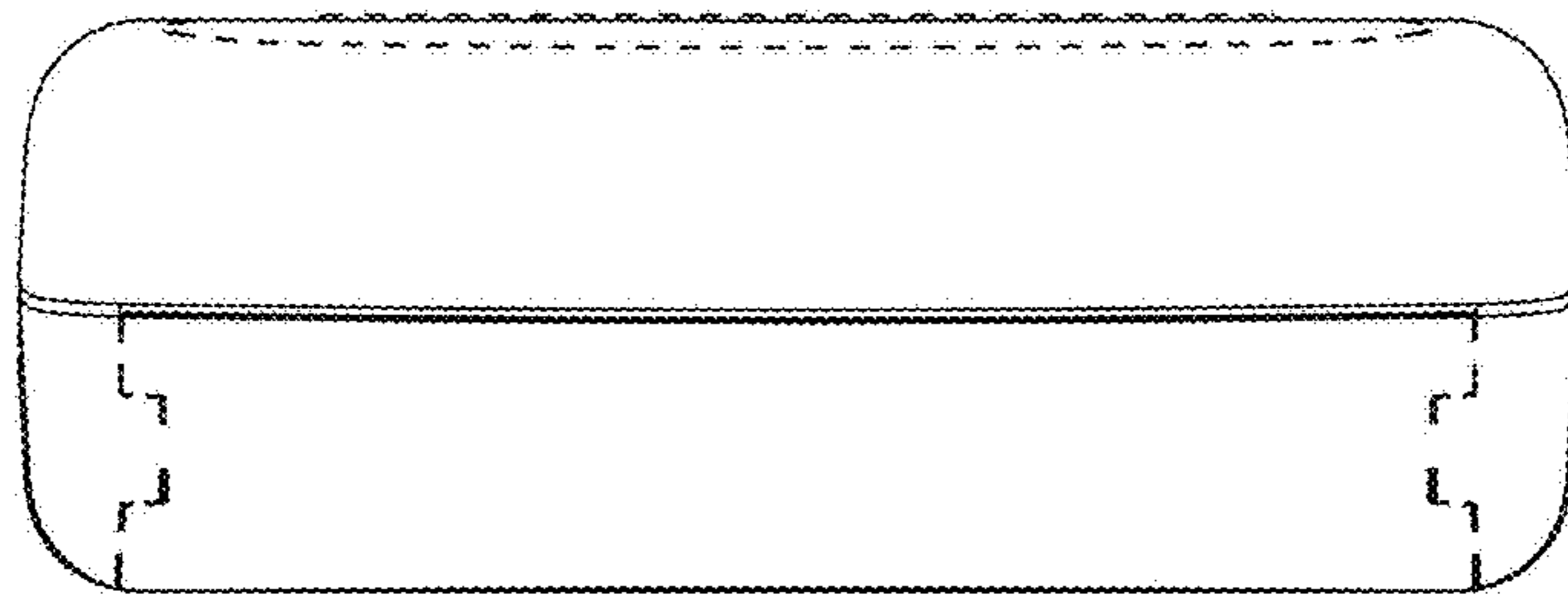

FIG. 5

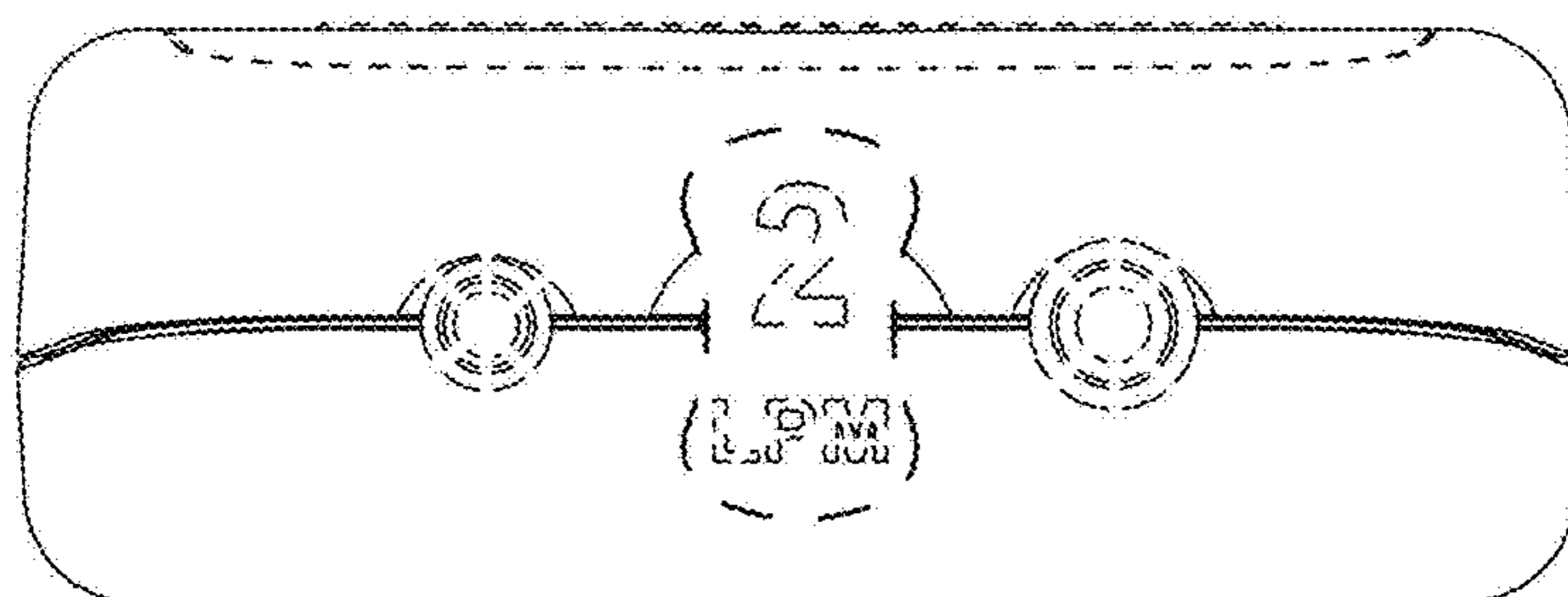

FIG. 6

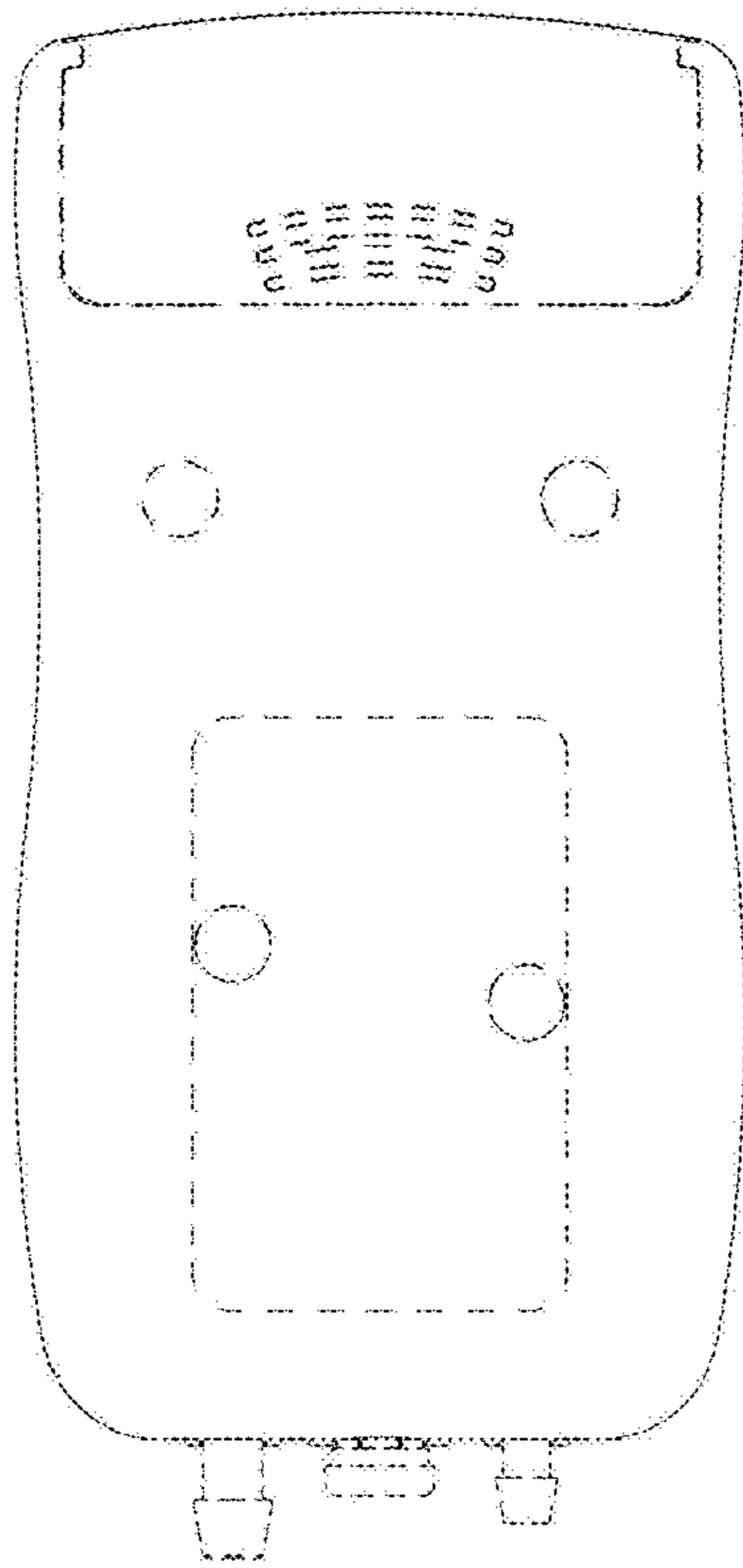

FIG. 7



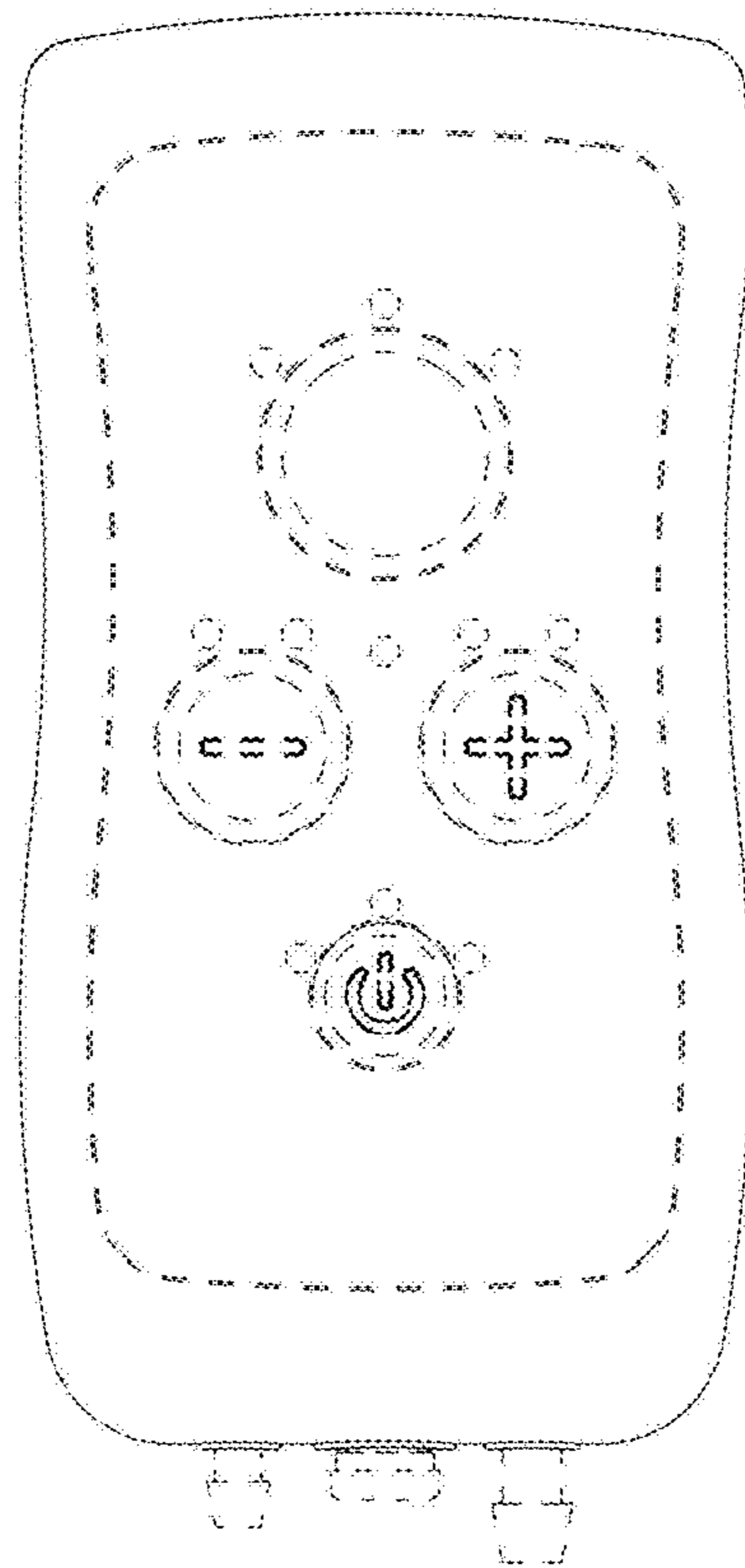

FIG. 8