



US00D851755S

(12) **United States Design Patent**
Nazzaro et al.

(10) **Patent No.:** **US D851,755 S**
(45) **Date of Patent:** **** Jun. 18, 2019**

(54) **OCULAR INSERTER**
(71) Applicant: **pSivida US, Inc.**, Watertown, MA (US)
(72) Inventors: **Martin Nazzaro**, Quincy, MA (US);
Josh York, Ipswich, MA (US); **Ron Leblanc**, Hopedale, MA (US)
(73) Assignee: **EyePoint Pharmaceuticals US, Inc.**,
Watertown, MA (US)
(**) Term: **15 Years**

5,997,500 A * 12/1999 Cook A61M 37/0069
604/141
6,001,089 A * 12/1999 Burroughs A61M 5/31551
604/208
6,007,515 A * 12/1999 Epstein A61B 17/00491
604/131
D424,197 S * 5/2000 Sydlowski D24/133
6,645,192 B2 * 11/2003 Kenison A61K 9/0024
424/408
7,090,681 B2 8/2006 Weber et al.
7,326,185 B2 * 2/2008 Brand A61M 5/3257
604/110
7,468,065 B2 12/2008 Weber et al.
(Continued)

(21) Appl. No.: **29/543,267**
(22) Filed: **Oct. 22, 2015**
(51) **LOC (11) Cl.** **24-02**
(52) **U.S. Cl.**
USPC **D24/114**
(58) **Field of Classification Search**
USPC D24/112–114, 108, 133, 130, 127, 186;
606/181, 185; 604/506, 60, 63, 264, 272,
604/187, 181, 184, 227
CPC A61M 5/178; A61M 3/00; A61M 5/20;
A61M 5/31; A61M 5/3146; A61M
5/3148; A61M 5/315
See application file for complete search history.

FOREIGN PATENT DOCUMENTS

CN 101596337 A 12/2009
DE 10 2008 006 602 A1 7/2009
(Continued)

Primary Examiner — David G Muller
(74) *Attorney, Agent, or Firm* — Hogan Lovells US LLP

(57) **CLAIM**

The ornamental design for an ocular inserter, as shown and described.

DESCRIPTION

FIG. 1 is a first perspective view of a first embodiment of an ocular inserter showing our new design;
FIG. 2 is a second perspective view thereof;
FIG. 3 is a left side view thereof;
FIG. 4 is a top view thereof;
FIG. 5 is a right side view thereof;
FIG. 6 is a bottom view thereof;
FIG. 7 is a front view thereof; and,
FIG. 8 is a rear view thereof.
The broken line showing of parts of the drawings is included for the purpose of illustrating use and environment and forms no part of the claimed design.

1 Claim, 5 Drawing Sheets

(56) **References Cited**

U.S. PATENT DOCUMENTS

3,094,121 A 6/1963 Blumenstein et al.
3,483,810 A 12/1969 Peters
4,105,030 A 8/1978 Kercso
4,810,244 A 3/1989 Allen
4,820,267 A 4/1989 Harman
5,057,082 A 10/1991 Burchette, Jr.
5,250,026 A 10/1993 Ehrlich et al.
5,273,532 A 12/1993 Niezink et al.
5,284,479 A 2/1994 de Jong
5,370,630 A 12/1994 Smidebush et al.
5,792,099 A 8/1998 DeCamp et al.

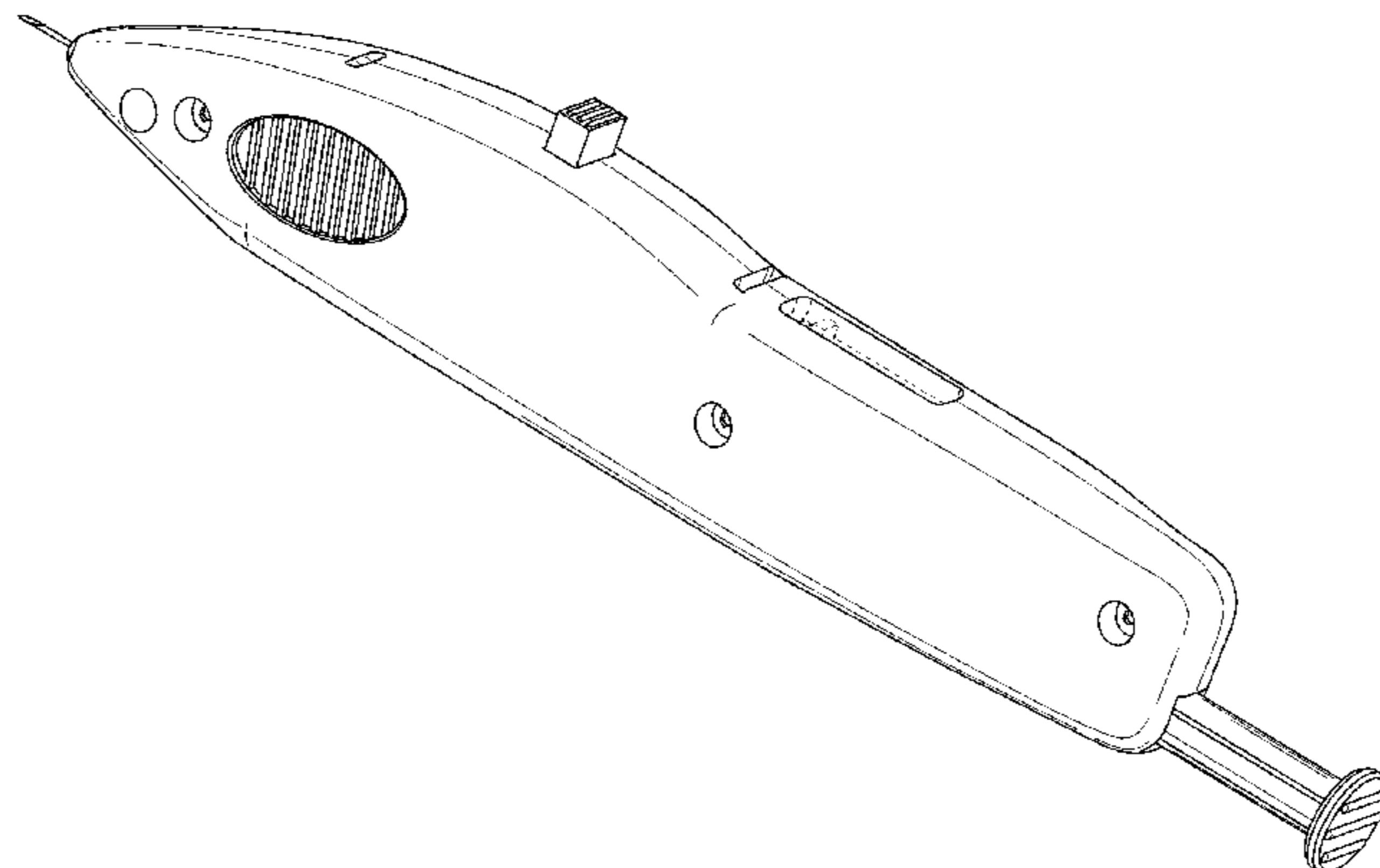

(56)

References Cited

U.S. PATENT DOCUMENTS

7,736,330 B2 * 6/2010 Bardy A61B 17/3468
604/57

7,798,988 B2 9/2010 Aubert et al.

7,976,490 B2 7/2011 Lawler et al.

D653,329 S * 1/2012 Lee-Sepsick D24/112

8,131,346 B2 3/2012 Chesbrough et al.

D681,808 S * 5/2013 Holaschke D24/114

8,663,162 B2 * 3/2014 Bunting A45D 34/04
604/116

8,790,293 B2 * 7/2014 Nazzaro A61F 9/0017
604/506

8,945,086 B2 * 2/2015 Becker A61M 5/329
604/164.12

8,968,236 B2 * 3/2015 Jennings A61M 5/2033
128/204.25

2003/0004457 A1 1/2003 Andersson

2003/0093084 A1 5/2003 Nissan et al.

2004/0199140 A1 10/2004 Rue et al.

2004/0230183 A1 11/2004 Breegi et al.

2004/0243101 A1 12/2004 Gillis

2004/0260300 A1 12/2004 Gorenssek et al.

2006/0111605 A1 5/2006 Larsen et al.

2006/0235430 A1 10/2006 Le et al.

2007/0073248 A1 3/2007 Moenning

2007/0073265 A1 3/2007 Rue et al.

2007/0191863 A1 8/2007 De Juan et al.

2008/0195135 A1 8/2008 Attinger

2008/0281292 A1 11/2008 Hickingbotham et al.

2009/0281520 A1 11/2009 Highley et al.

2009/0299298 A1 12/2009 Bussmann

2010/0234817 A1 9/2010 Nazzaro et al.

2012/0016572 A1 1/2012 Maas et al.

2012/0041369 A1 2/2012 Becker

2012/0165723 A1 6/2012 Horvath et al.

FOREIGN PATENT DOCUMENTS

EP 0239244 A1 9/1987

EP 03596162 A1 5/1994

EP 0639387 A1 2/1995

JP 2001-502937 A 3/2001

JP 2003-509082 A 3/2003

JP 2005-533619 A 11/2005

JP 2006-320736 A 11/2006

JP 2006-525953 A 11/2006

JP 2008-508916 A 3/2008

WO 1994/011042 A1 5/1994

WO 1999/053991 A1 10/1999

WO 2004/026106 A2 4/2004

WO WO-2005/053774 A1 6/2005

WO 2007/142890 A2 12/2007

WO 2008/033426 A1 3/2008

WO 2008/070402 A2 6/2008

WO 2008/088623 A2 7/2008

* cited by examiner

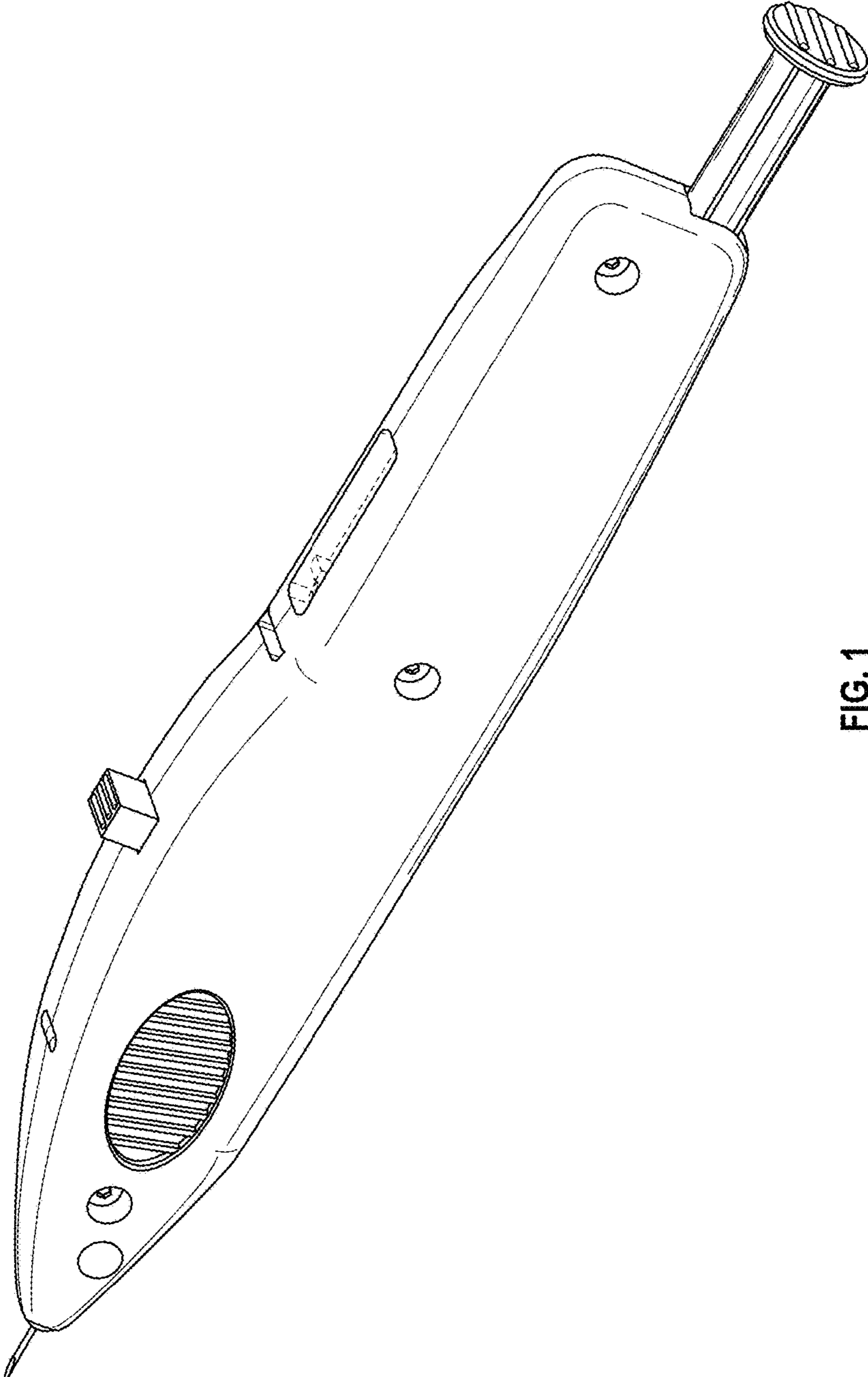

FIG. 1

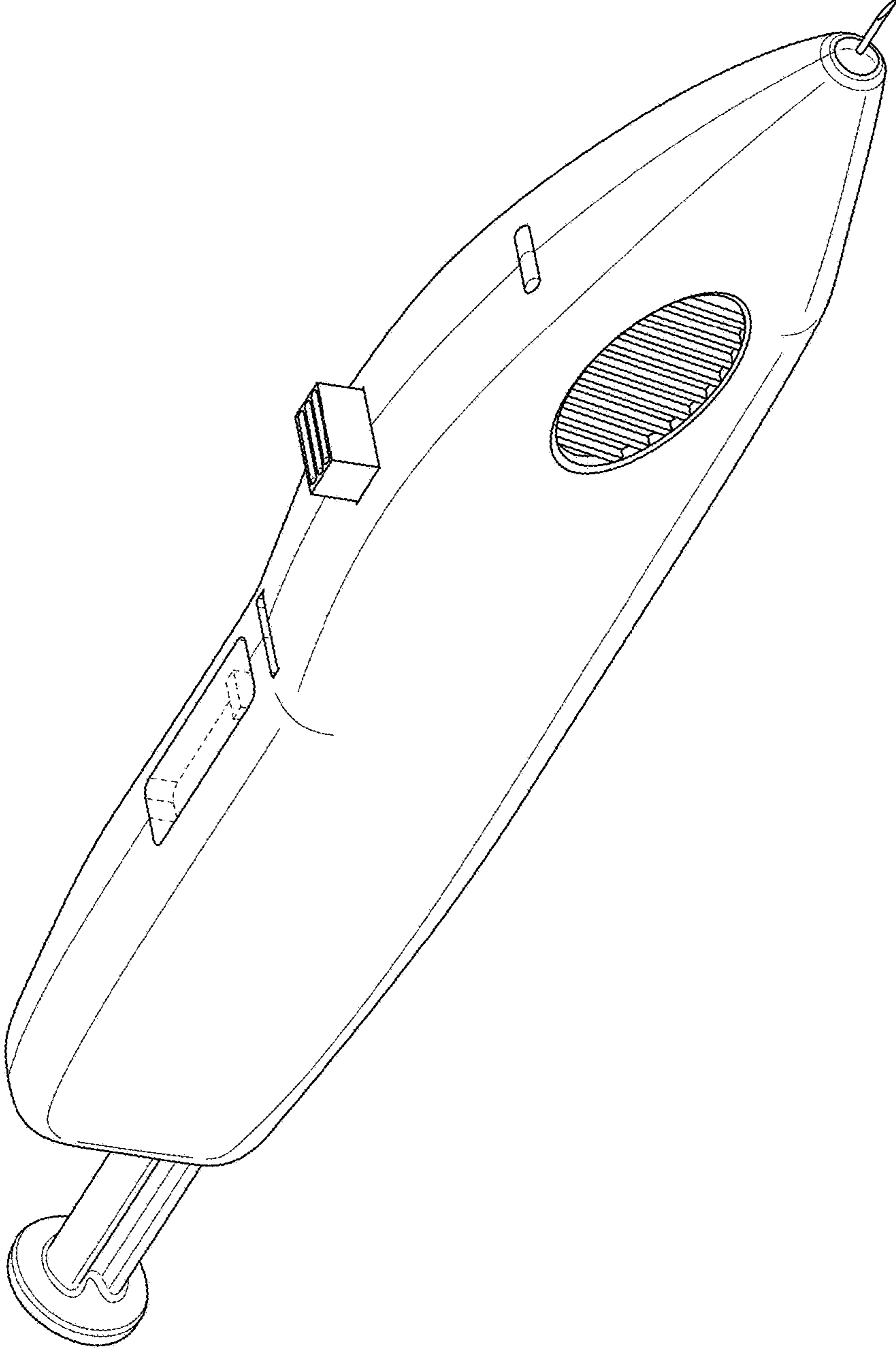

FIG. 2

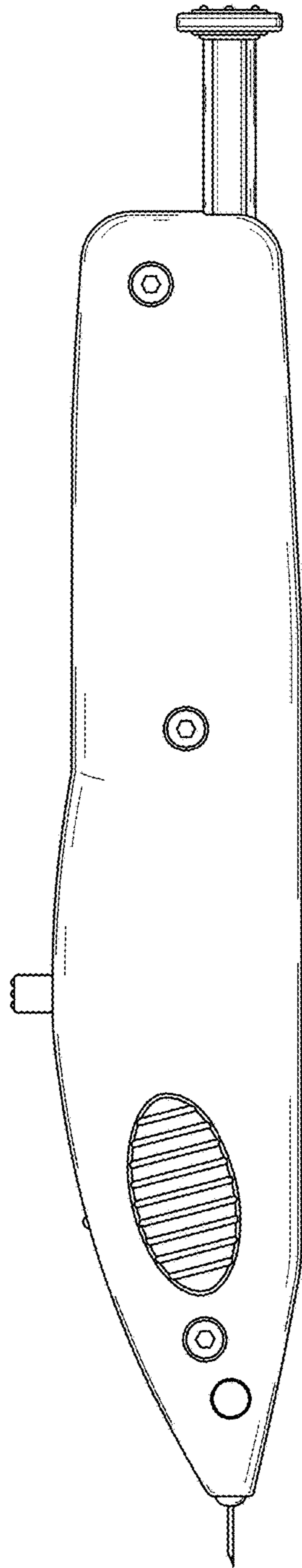

FIG. 3

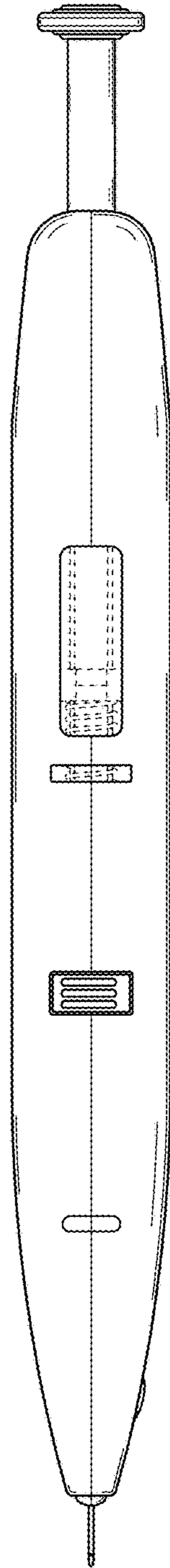

FIG. 4

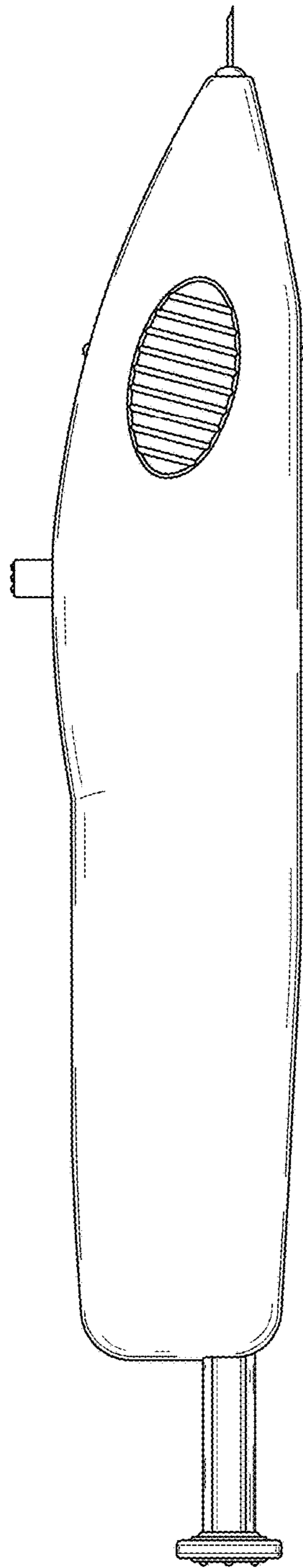

FIG. 5

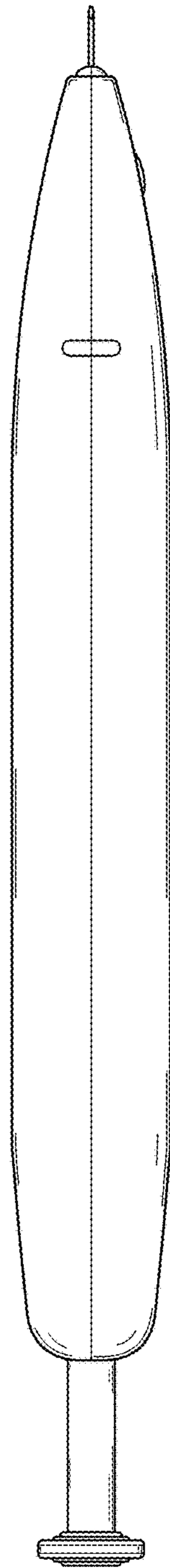

FIG. 6

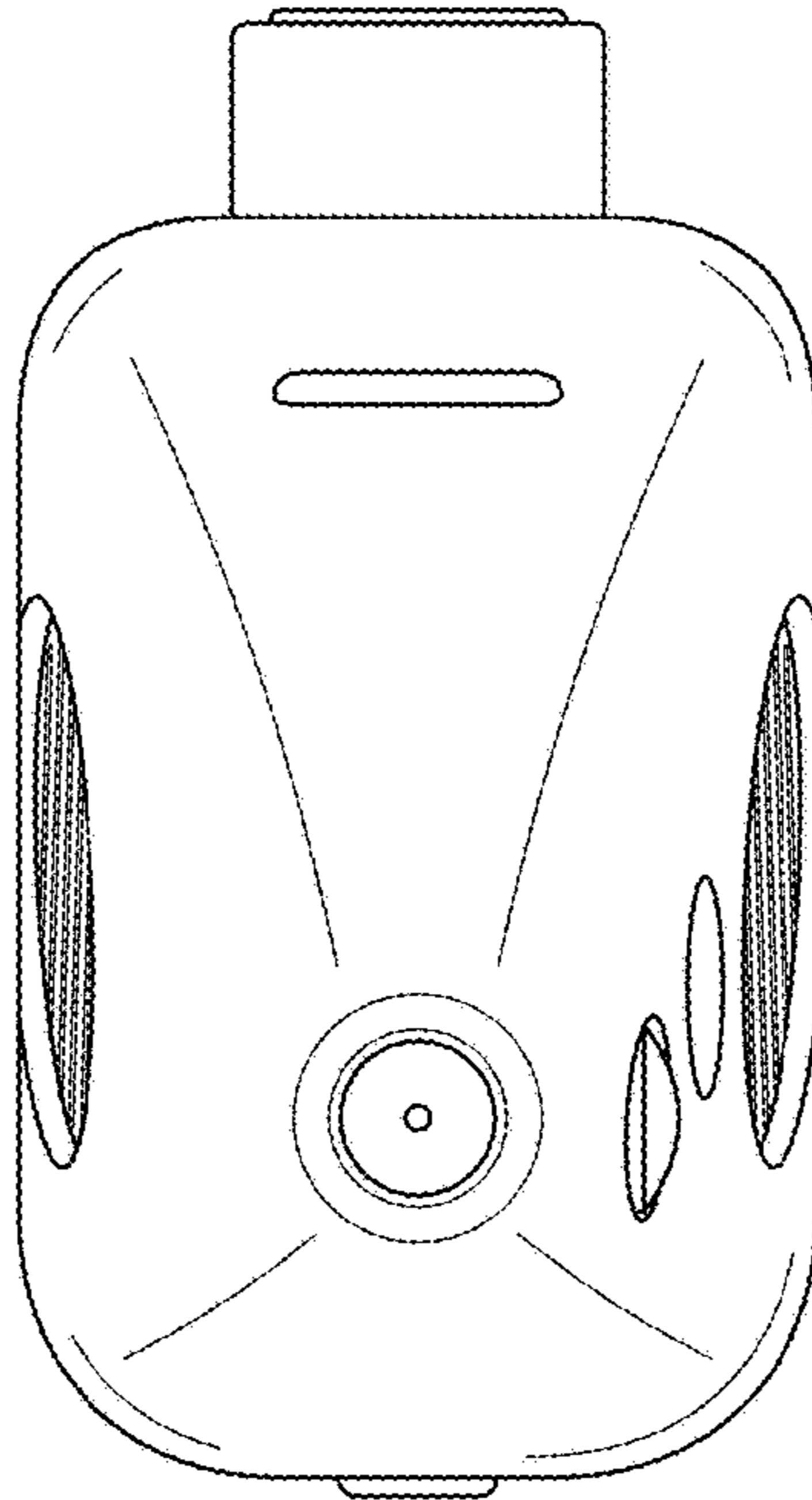

FIG. 7

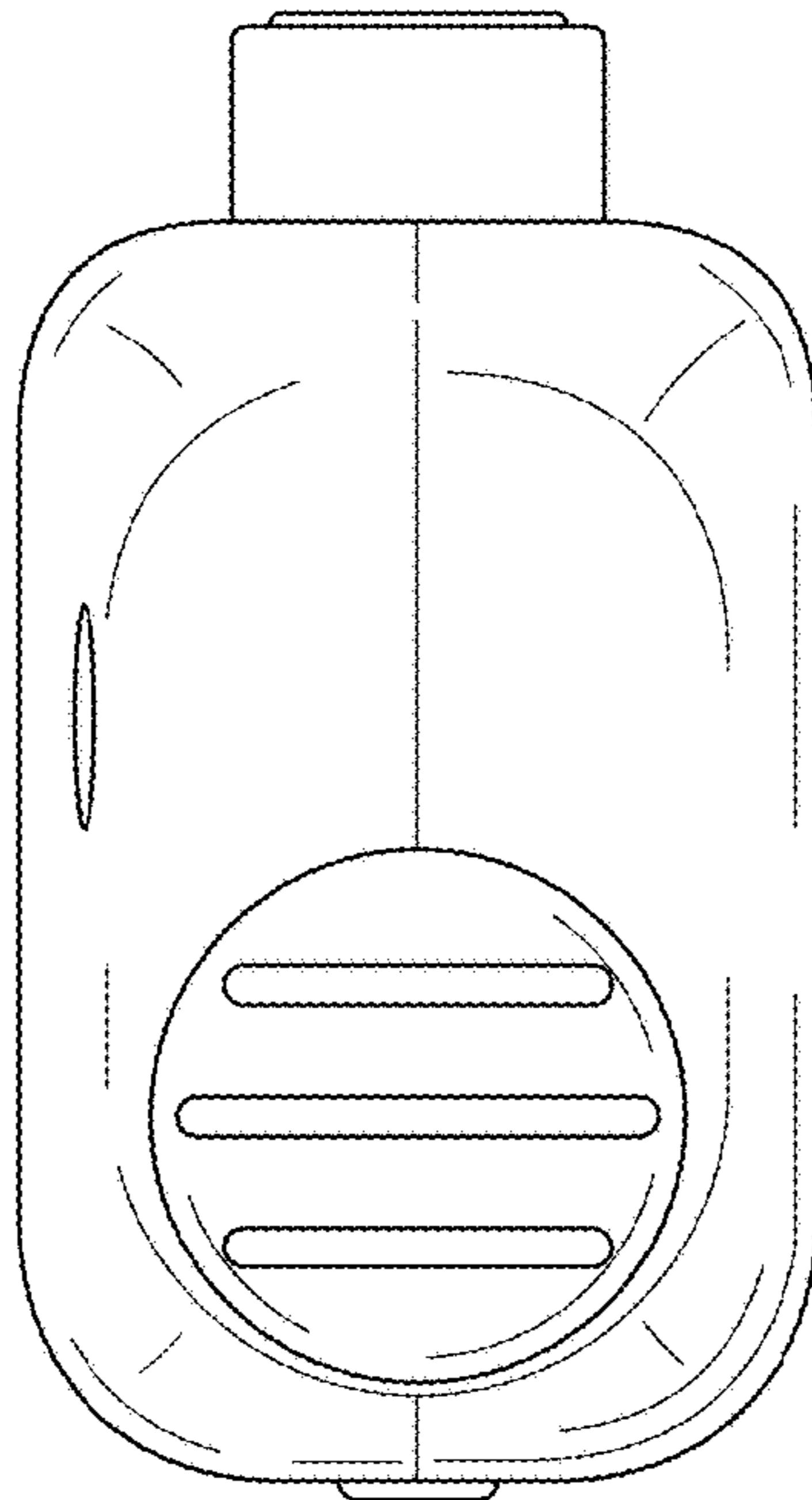

FIG. 8