



US00D851750S

(12) **United States Design Patent**
Collazo et al.

(10) **Patent No.:** **US D851,750 S**
(45) **Date of Patent:** **** Jun. 18, 2019**

(54) **RESPIRATORY MASK**

(71) Applicant: **InnoMed Healthscience, Inc.**, Coconut Creek, FL (US)

(72) Inventors: **Louis Javier Collazo**, Pompano Beach, FL (US); **Christopher Agami**, Coral Springs, FL (US); **Bruce M. Sher**, North Palm Beach, FL (US); **Shara A. Hernandez**, Davie, FL (US)

(73) Assignee: **InnoMed Healthscience, Inc.**, Coconut Creek, FL (US)

(**) Term: **15 Years**

(21) Appl. No.: **29/626,210**

(22) Filed: **Nov. 15, 2017**

(51) **LOC (11) Cl.** **29-02**

(52) **U.S. Cl.**
USPC **D24/110.1**

(58) **Field of Classification Search**
USPC D24/110-110.6, 127, 129; D29/110
CPC A61M 16/0616; A61M 16/0633; A61M 16/06; A61M 16/0666; A61M 16/0683; A61M 16/0605; A61M 16/0622; A61M 16/0644; A61M 16/0875; A61M 16/0816; A61M 16/08; B63C 11/205; B63C 11/16; B63C 11/186; B63C 11/12
See application file for complete search history.

(56) **References Cited**

U.S. PATENT DOCUMENTS

D377,089 S * 12/1996 Starr D24/110.1
D494,675 S * 8/2004 Guney D24/110.1

D530,007 S * 10/2006 Guney D24/110.1
D582,545 S * 12/2008 Omura D24/110.1
D585,981 S * 2/2009 Moore D24/110.1
D588,689 S * 3/2009 Guney D24/110.1
D597,200 S * 7/2009 Grimsley D24/110.1
D613,850 S * 4/2010 Holmquist-Brown D24/110.1
D614,761 S * 4/2010 Brambilla D24/110.1
D770,035 S * 10/2016 Prentice D24/110.1
D823,455 S * 7/2018 Bornholdt D24/110.4

* cited by examiner

Primary Examiner — Lilyana Bekic

Assistant Examiner — Aula Soroush

(74) *Attorney, Agent, or Firm* — Maier & Maier, PLLC

(57) **CLAIM**

The ornamental design for a respiratory mask, as shown and described.

DESCRIPTION

FIG. 1 is a front perspective view of a respiratory mask; FIG. 2 is a rear perspective view thereof; FIG. 3 is a front elevation view thereof; FIG. 4 is a rear elevation view thereof; FIG. 5 is a right side elevation view thereof; FIG. 6 is a left side elevation view thereof; FIG. 7 is a top plan view thereof; and, FIG. 8 is a bottom plan view thereof. The broken line showing of portions of the respiratory mask form no part of the claimed design.

1 Claim, 4 Drawing Sheets

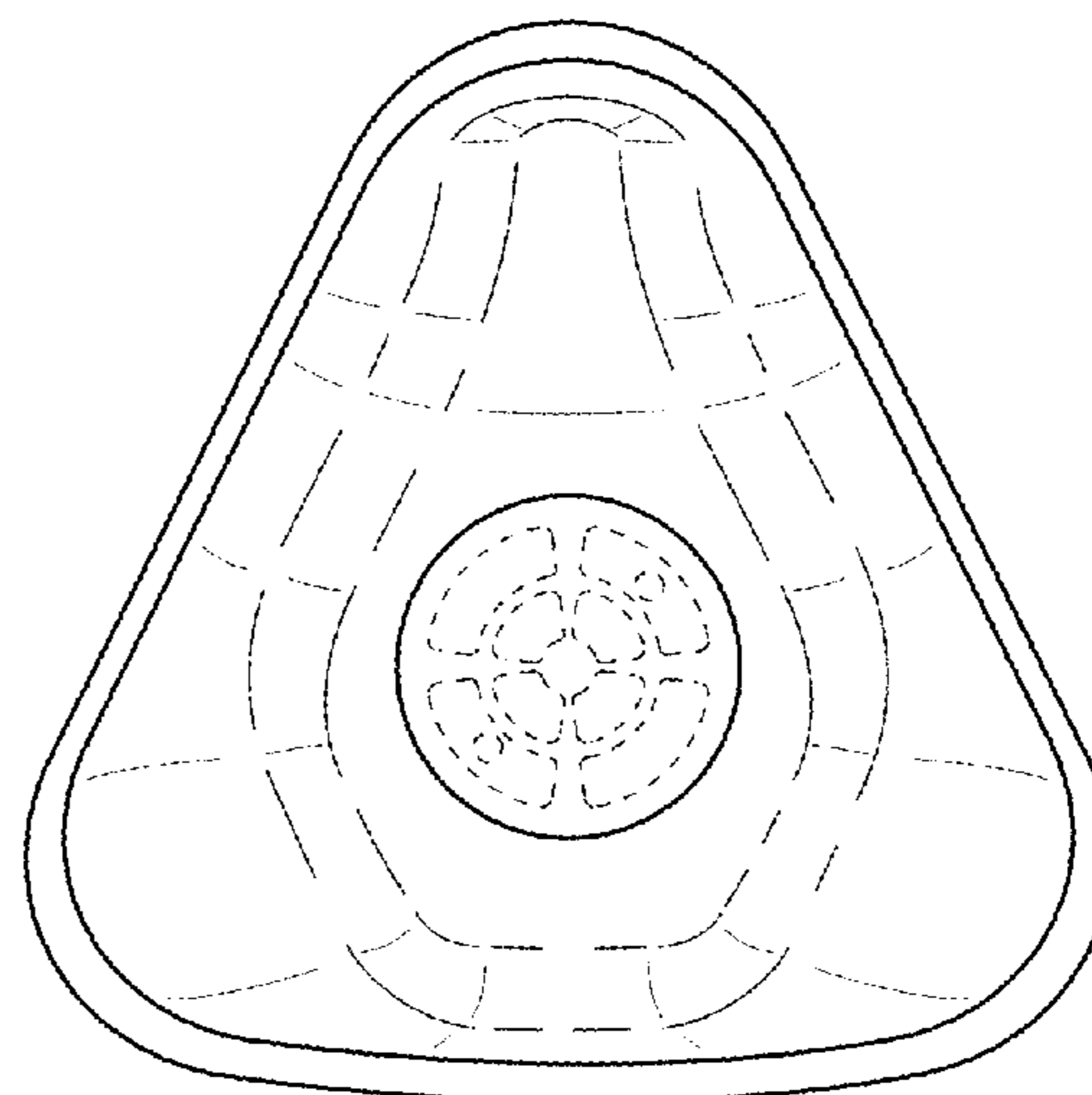
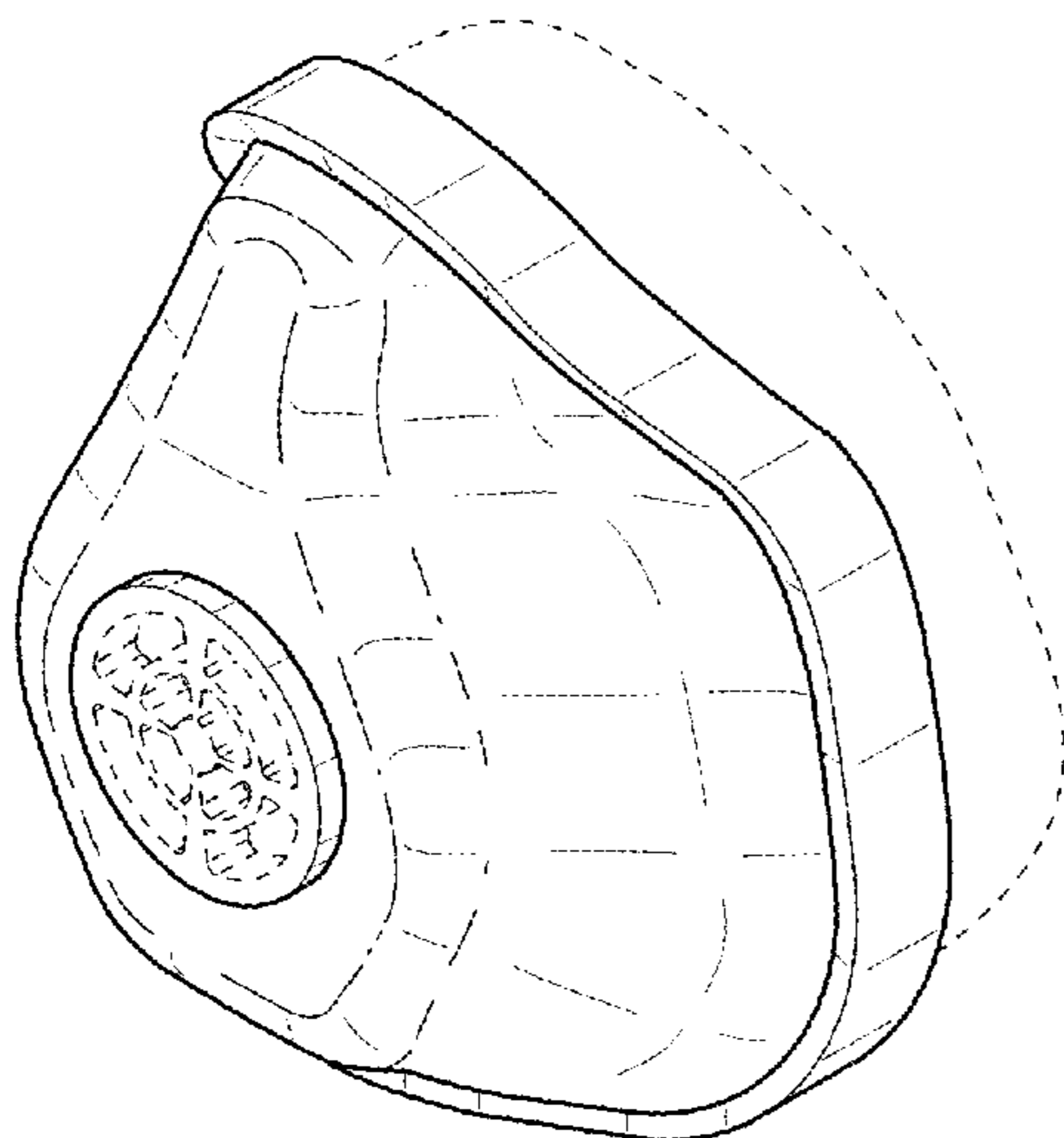

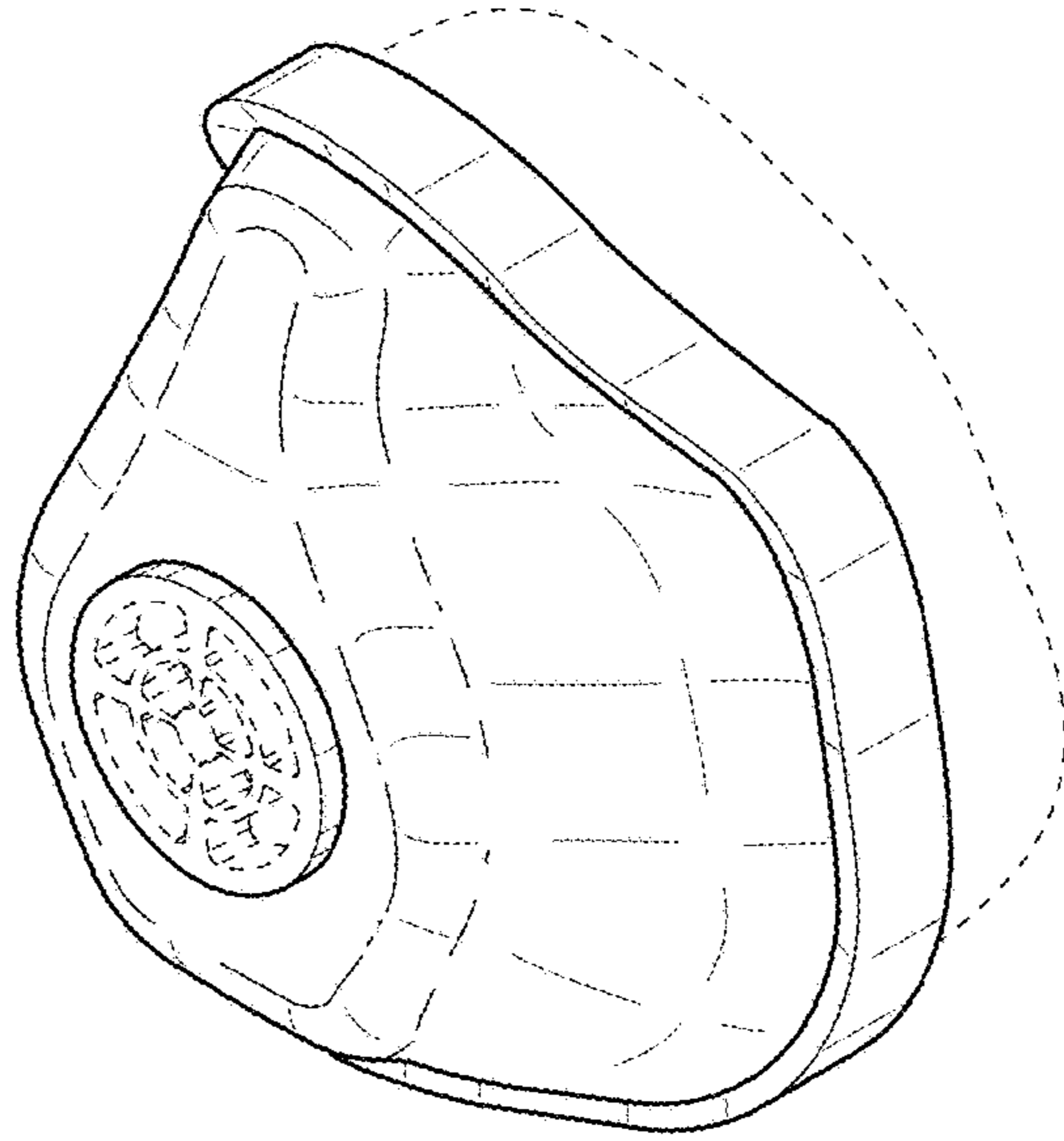

Fig. 1

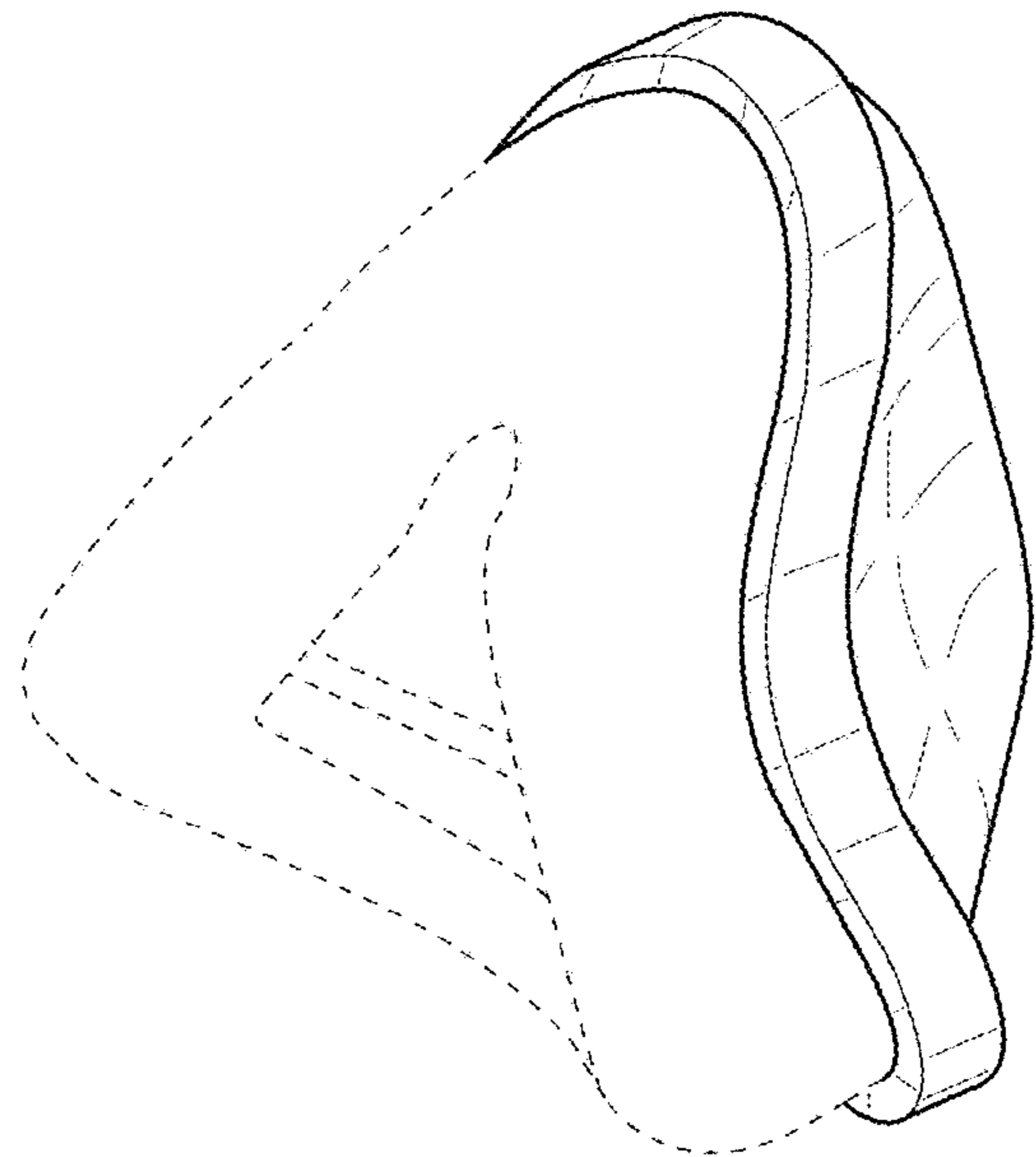

Fig. 2

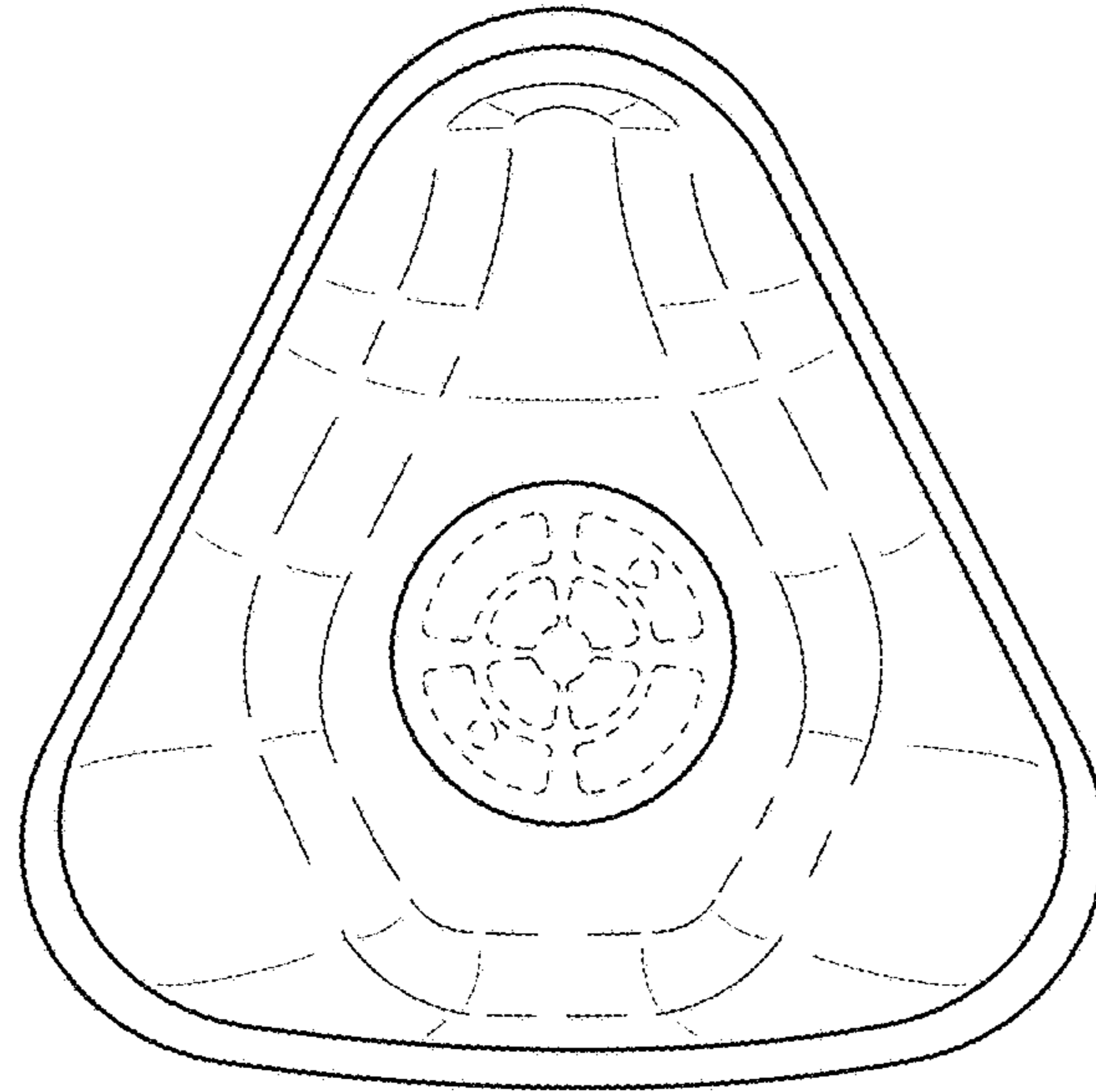

Fig. 3

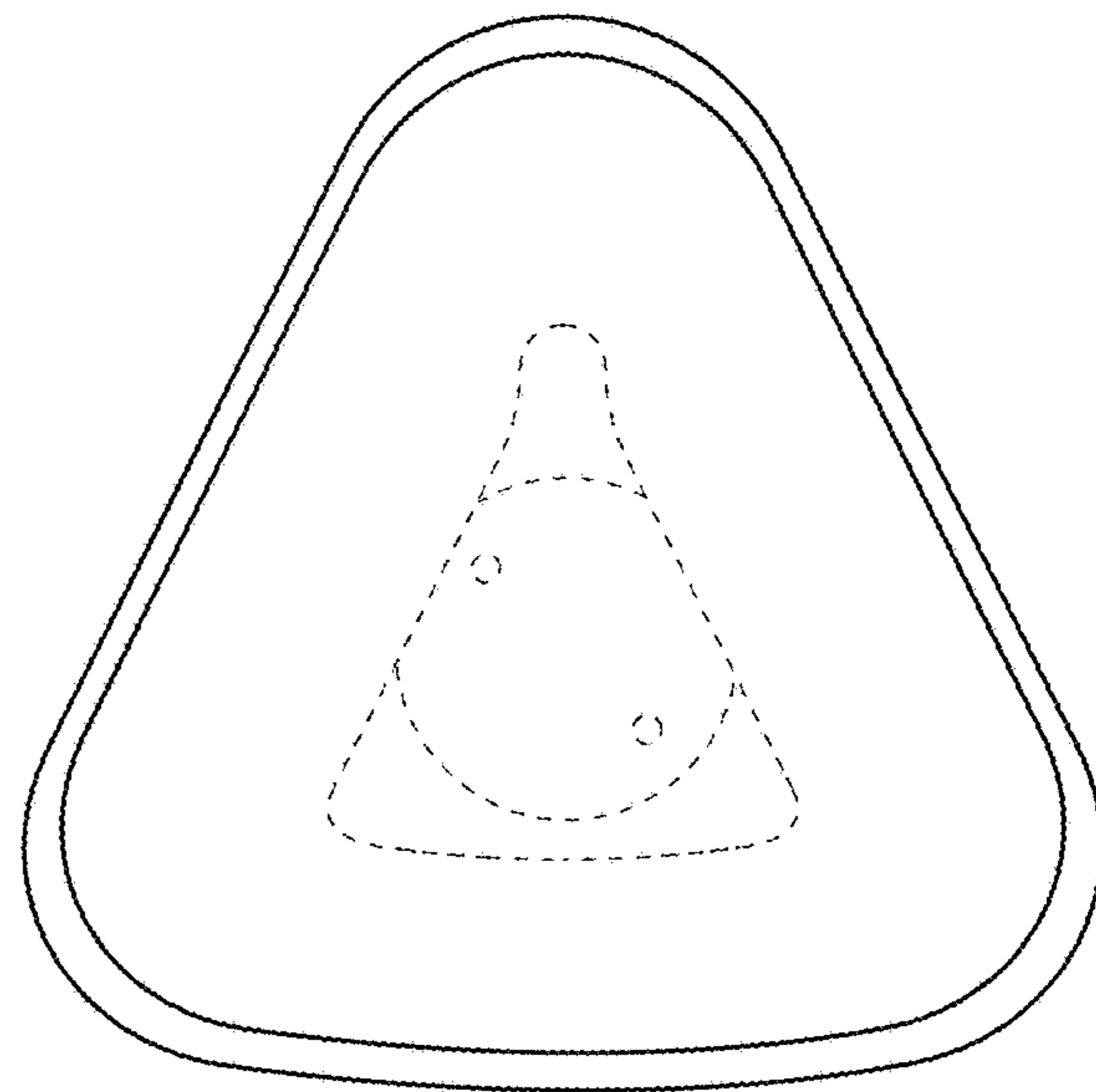

Fig. 4

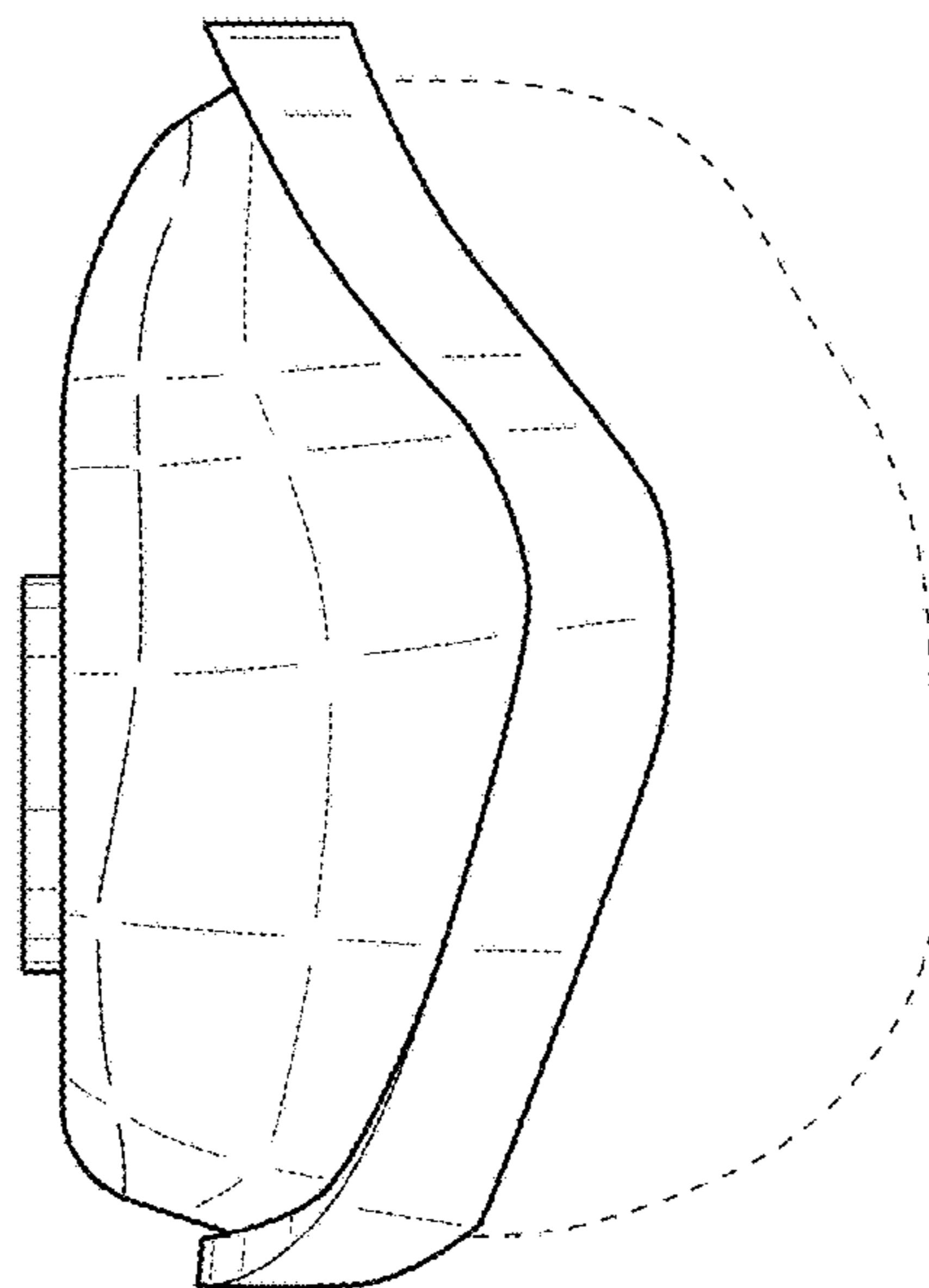

Fig. 5

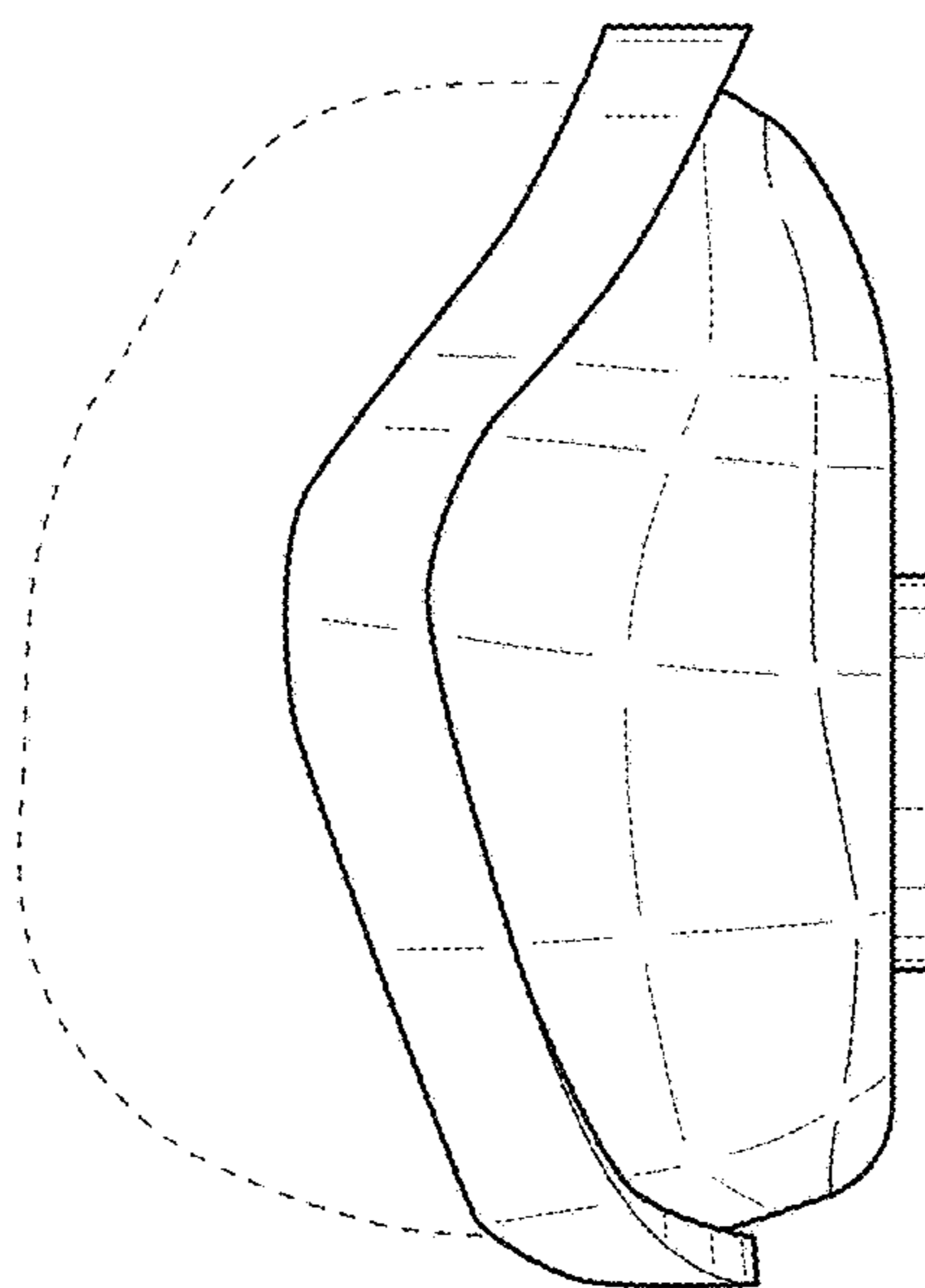

Fig. 6

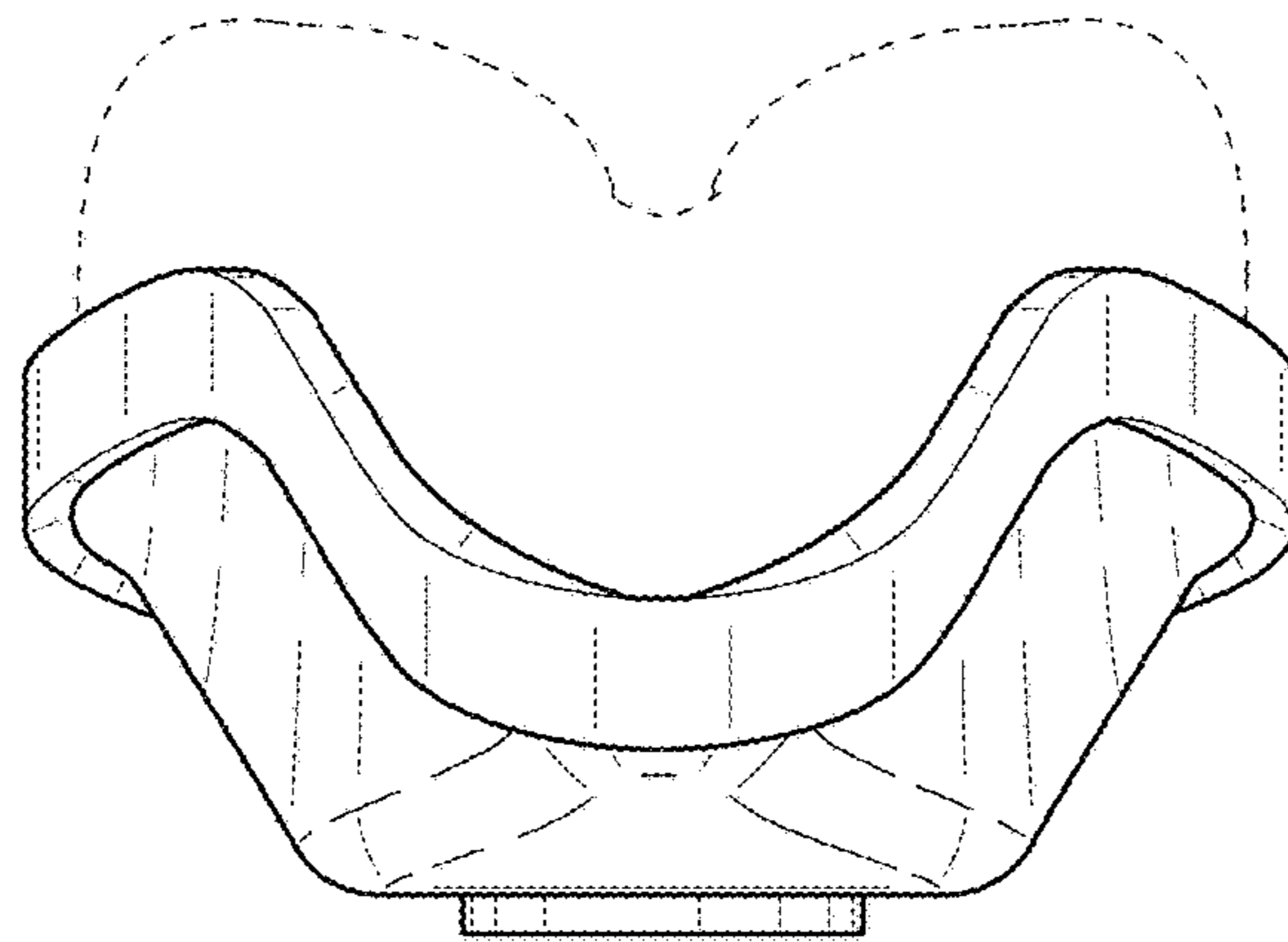

Fig. 7

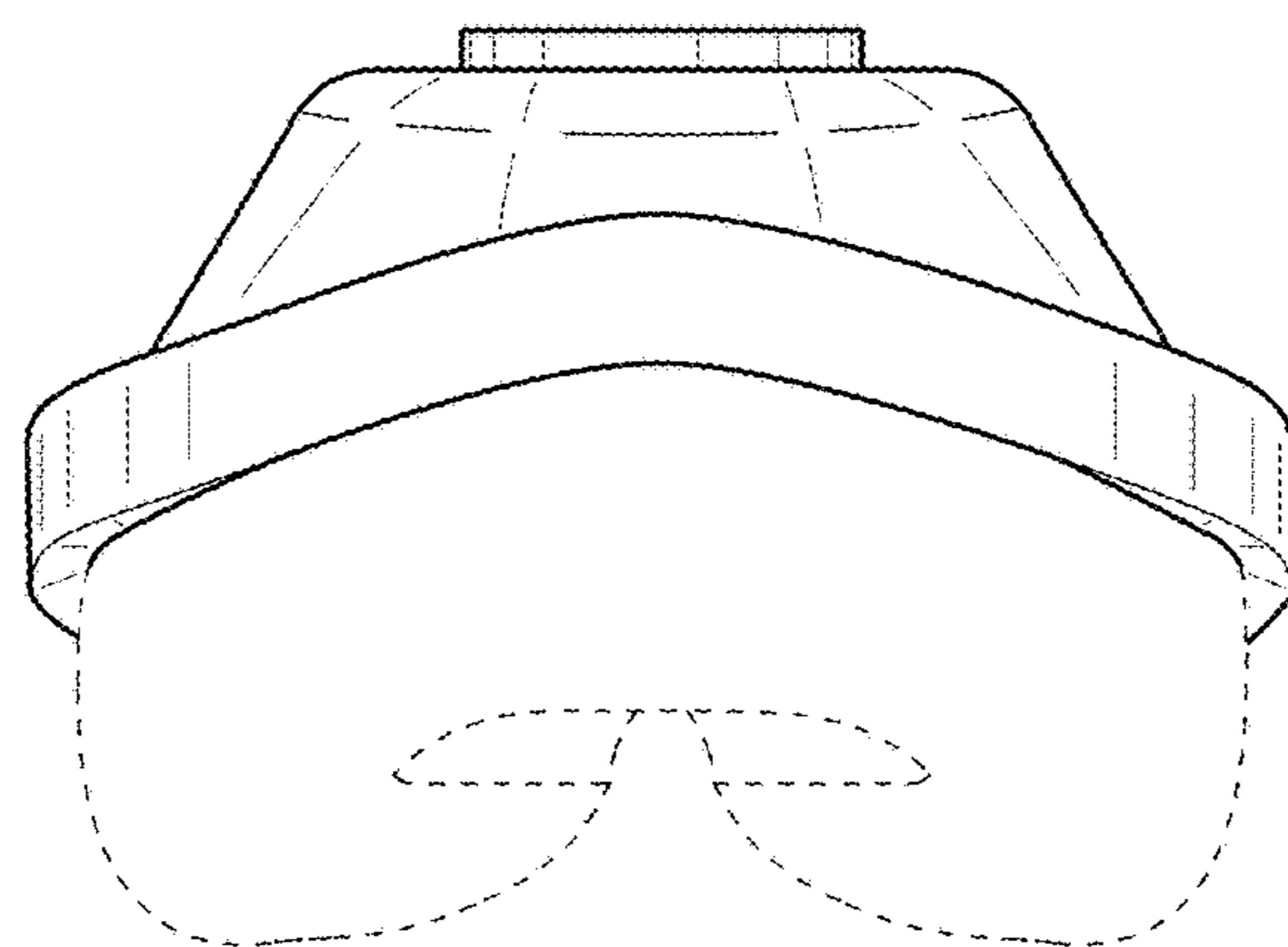

Fig. 8